

AC Servo Drives  
 **$\Sigma$ -V Series**  
**USER'S MANUAL**  
**Design and Maintenance**  
Linear Motor  
Command Option Attachable Type

SGDV SERVOPACK  
SGLGW/SGLFW/SGLTW/SGLC/SGT Linear Servomotors

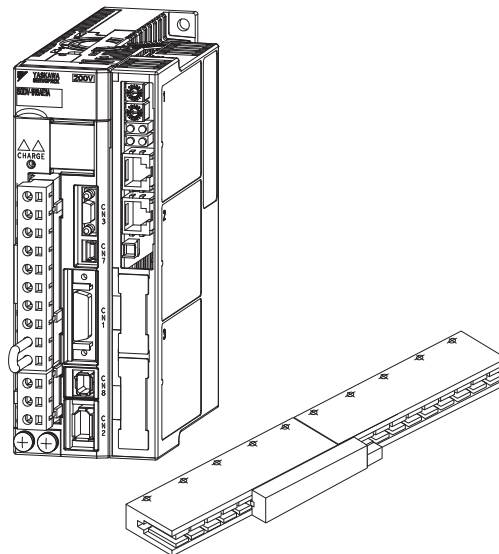

Outline	1
Panel Display and Operation of Digital Operator	2
Wiring and Connection	3
Operation	4
Adjustments	5
Utility Functions (Fn□□□)	6
Monitor Displays (Un□□□)	7
Troubleshooting	8
Appendix	9

Copyright © 2009 YASKAWA ELECTRIC CORPORATION

---

All rights reserved. No part of this publication may be reproduced, stored in a retrieval system, or transmitted, in any form, or by any means, mechanical, electronic, photocopying, recording, or otherwise, without the prior written permission of Yaskawa. No patent liability is assumed with respect to the use of the information contained herein. Moreover, because Yaskawa is constantly striving to improve its high-quality products, the information contained in this manual is subject to change without notice. Every precaution has been taken in the preparation of this manual. Nevertheless, Yaskawa assumes no responsibility for errors or omissions. Neither is any liability assumed for damages resulting from the use of the information contained in this publication.

---

## About this Manual

This manual describes information required for designing, testing, adjusting, and maintaining  $\Sigma$ -V Series SERVOPACKs.

Keep this manual in a location where it can be accessed for reference whenever required. Manuals outlined on the following page must also be used as required by the application.

### ■ Description of Technical Terms

The following table shows the meanings of terms used in this manual.

Term	Meaning
Cursor	Input position indicated by Digital Operator
Servomotor	$\Sigma$ -V Series SGLGW, SGLFW, SGLTW, SGLC linear servomotor or SGT linear slider
SERVOPACK	$\Sigma$ -V Series SGD V servo amplifier of command option attachable type
Servo Drive	A set including a servomotor and SERVOPACK (i.e., a servo amplifier)
Servo System	A servo control system that includes the combination of a servo drive with a host controller and peripheral devices
Servo ON	Power to motor ON
Servo OFF	Power to motor OFF
Base Block (BB)	Power supply to motor is turned OFF by shutting off the base current to the power transistor in the current SERVOPACK.
Servo Lock	A state in which the motor is stopped and is in position loop with a position reference of 0.
Main Circuit Cable	Cables which connect to the main circuit terminals, including main circuit power supply cables, control power supply cables, servomotor main circuit cables, and others.
Zero-speed Stopping	Stopping the servomotor by setting the speed reference to 0
Linear Scale Connection Cables	A set of cables including a cable for connecting serial converter unit, a cable for connecting linear scale, and a cable for connecting hall sensor

### ■ IMPORTANT Explanations

The following icon is displayed for explanations requiring special attention.



IMPORTANT

- Indicates important information that should be memorized, as well as precautions, such as alarm displays, that do not involve potential damage to equipment.



## ■ Manuals Related to the $\Sigma$ -V Series

Refer to the following manuals as required.

Name	Selecting Models and Peripheral Devices	Ratings and Specifications	System Design	Panels and Wiring	Trial Operation	Trial Operation and Servo Adjustment	Maintenance and Inspection
$\Sigma$ -V Series User's Manual Setup Linear Motor (No.: SIEP S800000 44)	-	-	-	✓	✓	-	-
$\Sigma$ -V Series Product Catalog (No.: KAEP S800000 42)	✓	✓	✓	-	-	-	-
$\Sigma$ -V Series User's Manual Design and Maintenance Linear Motor/ Command Option Attachable Type (this manual)	-	-	✓	-	✓	✓	✓
$\Sigma$ -V Series/ $\Sigma$ -V Series for Large-Capacity Models User's Manual INDEXER Module (No.: SIEP C720829 02)	-	✓	✓	-	✓	✓	✓
$\Sigma$ -V Series/ $\Sigma$ -V Series for Large-Capacity Models User's Manual DeviceNet Module (No.: SIEP C720829 07)	-	✓	✓	-	✓	✓	✓
$\Sigma$ -V Series User's Manual Operation of Digital Operator (No.: SIEP S800000 55)	-	-	-	-	✓	✓	✓
$\Sigma$ -V Series AC SERVOPACK SGD Safety Precautions (No.: TOBP C710800 10)	✓	-	-	✓	-	-	✓
$\Sigma$ Series Digital Operator Safety Precautions (No.: TOBP C730800 00)	-	-	-	-	-	-	✓
AC SERVOMOTOR Safety Precautions (No.: TOBP C230200 00)	-	-	-	✓	-	-	✓

---

## ■ Safety Information

The following conventions are used to indicate precautions in this manual. Failure to heed precautions provided in this manual can result in serious or possibly even fatal injury or damage to the products or to related equipment and systems.



Indicates precautions that, if not heeded, could possibly result in loss of life or serious injury.



Indicates precautions that, if not heeded, could result in relatively serious or minor injury, damage to the product, or faulty operation. In some situations, the precautions indicated could have serious consequences if not heeded.



Indicates prohibited actions that must not be performed. For example, this symbol would be used to indicate that fire is prohibited as follows:





Indicates compulsory actions that must be performed. For example, this symbol would be used to indicate that grounding is compulsory as follows:



## Safety Precautions

This section describes important precautions that must be followed during storage, transportation, installation, wiring, operation, maintenance, inspection, and disposal. Be sure to always observe these precautions thoroughly.

### WARNING

- If you have a pacemaker or any other electronic medical device, do not go near the magnetic way of the servomotor.  
Failure to observe this warning may result in the malfunction of the medical device.
- Be sure to use nonmagnetic tools when installing or working close to the servomotor.  
(Example: a beryllium-copper alloy hexagonal wrench set, made by NGK Insulators, Ltd.)
- Never touch the servomotor or machinery during operation.  
Failure to observe this warning may result in injury.
- Before starting operation with a machine connected, make sure that an emergency stop can be applied at any time.  
Failure to observe this warning may result in injury or damage to the equipment.
- Before wiring, install the SERVOPACK and the servomotor.  
Failure to observe this warning may result in electric shock.
- Never touch the inside of the SERVOPACKS.  
Failure to observe this warning may result in electric shock.
- Do not remove the cover of the power supply terminal block while the power is ON.  
Failure to observe this warning may result in electric shock.
- Do not touch the power supply terminals while the CHARGE lamp is ON after turning power OFF because high voltage may still remain in the SERVOPACK. Make sure the CHARGE lamp is OFF first before starting to do wiring or inspections.  
Residual voltage may cause electric shock.
- Follow the procedures and instructions provided in the manuals for the products being used in the trial operation.  
Failure to do so may result not only in faulty operation and damage to equipment, but also in personal injury.
- Do not remove the top front cover, cables, connectors, or optional items from the SERVOPACK while the power is ON.  
Failure to observe this warning may result in electric shock or equipment damage.
- Do not damage, pull, exert excessive force on, or place heavy objects on the cables.  
Failure to observe this warning may result in electric shock, stopping operation of the product, or fire.
- Do not modify the product.  
Failure to observe this warning may result in injury, damage to the equipment, or fire.
- Provide appropriate braking devices on the machine side to ensure safety.  
Failure to observe this warning may result in injury.
- Do not come close to the machine immediately after resetting an instantaneous power interruption to avoid an unexpected restart. Take appropriate measures to ensure safety against an unexpected restart.  
Failure to observe this warning may result in injury.
-  Connect the ground terminal according to local electrical codes (100 Ω or less for a SERVOPACK with a 100 V, 200 V power supply, 10 Ω or less for a SERVOPACK with a 400 V power supply).  
Improper grounding may result in electric shock or fire.
-  Installation, disassembly, or repair must be performed only by authorized personnel.  
Failure to observe this warning may result in electric shock or injury.
- The person who designs a system using the safety function (Hard Wire Baseblock function) must have full knowledge of the related safety standards and full understanding of the instructions in this manual.  
Failure to observe this warning may result in injury or damage to the equipment.

## ■ Storage and Transportation



### CAUTION

- Be sure to store the magnetic way in the package that was used for delivery.
- Do not store or install the product in the following locations.  
Failure to observe this caution may result in fire, electric shock, or damage to the equipment.
  - Locations subject to direct sunlight
  - Locations subject to temperatures outside the range specified in the storage/installation temperature conditions
  - Locations subject to humidity outside the range specified in the storage/installation humidity conditions
  - Locations subject to condensation as the result of extreme changes in temperature
  - Locations subject to corrosive or flammable gases
  - Locations subject to dust, salts, or iron dust
  - Locations subject to exposure to water, oil, or chemicals
  - Locations subject to shock or vibration
- Do not hold the servomotor by the cables while transporting it.  
Failure to observe this caution may result in injury or malfunction.
- Do not place any load exceeding the limit specified on the packing box.  
Failure to observe this caution may result in injury or malfunction.
- If disinfectants or insecticides must be used to treat packing materials such as wooden frames, pallets, or plywood, the packing materials must be treated before the product is packaged, and methods other than fumigation must be used.  
Example: Heat treatment, where materials are kiln-dried to a core temperature of 56°C for 30 minutes or more.  
  
If the electronic products, which include stand-alone products and products installed in machines, are packed with fumigated wooden materials, the electrical components may be greatly damaged by the gases or fumes resulting from the fumigation process. In particular, disinfectants containing halogen, which includes chlorine, fluorine, bromine, or iodine can contribute to the erosion of the capacitors.

## ■ Installation

### CAUTION

- When unpacking and installing magnetic way, check that no metal fragments or magnetized objects near the magnetic because they may be affected by the magnetic attraction of the magnetic way. Failure to observe this caution may result in injury or damage to the magnetic way's magnets.
- Do not use the magnetic way near metal or other magnetized objects. Failure to observe this caution may result in injury.
- Do not place clocks, magnetic cards, floppy disks, or measuring instruments close to the magnetic way. Failure to observe this caution may result in malfunction or damage to these items by the magnetic force.
- Securely mount the servomotor onto the machine. If the servomotor is not mounted securely, it may loosen during operation.
- Do not carry the magnetic way by its magnet protection cover. Failure to observe this caution may result in injury by the cover's edge or the shape of the cover may become distorted.

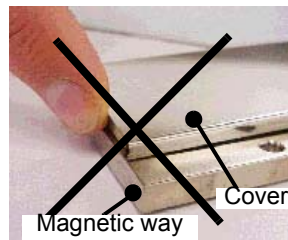

- When removing the dummy plate for reducing magnetic force used for the SGLFW magnetic way, pay attention to the magnetic attraction of the magnetic way. Do not place the removed plate close to the magnetic way. Failure to observe this caution may result in injury or damage to the magnetic way's magnets or the magnet protection cover.
- Install SERVOPACKs, servomotors, and regenerative resistors on nonflammable objects. Installation directly onto or near flammable objects may result in fire.
- Never use the product in an environment subject to water, corrosive gases, flammable gases, or combustibles. Failure to observe this caution may result in electric shock or fire.
- Do not step on or place a heavy object on the product. Failure to observe this caution may result in injury or malfunction.
- Do not cover the inlet or outlet ports and prevent any foreign objects from entering the product. Failure to observe this caution may cause internal elements to deteriorate resulting in malfunction or fire.
- Be sure to install the product in the correct direction. Failure to observe this caution may result in malfunction.
- Provide the specified clearances between the SERVOPACK and the control panel or with other devices. Failure to observe this caution may result in fire or malfunction.
- Do not apply any strong impact. Failure to observe this caution may result in malfunction.

## ■ Wiring



### CAUTION

- Be sure to wire correctly and securely.  
Failure to observe this caution may result in motor overrun, injury, or malfunction.
- Securely tighten the cable connector screws and securing mechanism.  
If the connector screws and securing mechanism are not secure, they may loosen during operation.
- Use cables with a radius, heat resistance, and flexibility suitable for the system.
- If the SERVOPACK malfunctions, turn OFF the main circuit's power supply of the SERVOPACK.  
The continuous flow of a large current may cause fire.
- Use a noise filter to minimize the effects of electromagnetic damage.  
Failure to observe this caution may result in electromagnetic damage to electronic devices used near the SERVOPACK.
- Do not connect a commercial power supply to the U, V, or W terminals for the servomotor connection.  
Failure to observe this caution may result in injury or fire.
- Securely connect the main circuit terminals.  
Failure to observe this caution may result in fire.
- Do not bundle or run the main circuit cables together with the I/O signal cables or the linear scale connection cables in the same duct. Keep the main circuit cables separated from the I/O signal cables and the linear scale connection cables with a gap of at least 30 cm.  
Placing these cables too close to each other may result in malfunction.
- Use shielded twisted-pair cables or screened unshielded twisted-pair cables for I/O signal cables and the linear scale connection cables.
- Make sure that the length of each cable is equal to or shorter than the maximum wiring length listed here.
  - I/O signal cables: 3 m
  - Connection cables for linear servomotor main circuit: 20 m
  - Connection cables for serial converter unit: 20 m
  - Connection cables for linear scale: 15 m
  - Connection cables for hall sensor: 15 m
  - Control power supply cables for the SERVOPACK with a 400-V power supply (+24 V, 0 V): 10 m
- Be sure to observe the following precautions when wiring the SERVOPACK main circuit terminal blocks.
  - Do not turn the SERVOPACK power ON until all wiring, including the main circuit terminal blocks, has been completed.
  - If a connector is used for the main circuit terminals, remove the connector from the SERVOPACK before you wire it.
  - Insert only one wire into one opening in the main circuit connector.
  - Make sure that no part of the core wire comes into contact with (i.e., short-circuits) adjacent wires.
- Do not connect the SERVOPACK for 200 V directly to a voltage of 400 V.  
The SERVOPACK will be destroyed.
- Always use the specified power supply voltage.  
An incorrect voltage may result in fire or malfunction.
- Make sure that the polarity is correct.  
Incorrect polarity may cause ruptures or damage.
- Take appropriate measures to ensure that the input power supply is supplied within the specified voltage fluctuation range. Be particularly careful in places where the power supply is unstable.  
An incorrect power supply may result in damage to the equipment.
- Install external breakers or other safety devices against short-circuiting in external wiring.  
Failure to observe this caution may result in fire.
- Take appropriate and sufficient countermeasures for each form of potential interference when installing systems in the following locations.
  - Locations subject to static electricity or other forms of noise
  - Locations subject to strong electromagnetic fields and magnetic fields
  - Locations subject to possible exposure to radioactivity
  - Locations close to power suppliesFailure to observe this caution may result in damage to the equipment.
- Wiring or inspection must be performed by a technical expert.
- Use a 24-VDC power supply with double insulation or reinforced insulation.

## ■ Operation

### CAUTION

- Do not stand within the machine's range of motion during operation.  
Failure to observe this caution may result in injury.
- Always use the servomotor and SERVOPACK in one of the specified combinations.  
Failure to observe this caution may result in fire or malfunction.
- Before operation, install limit switches or stoppers at the ends of the range of movement to prevent unexpected accidents.  
Failure to observe this caution may result in injury.
- During trial operation, confirm that the holding brake works correctly. Furthermore, secure system safety against problems such as signal line disconnection.  
Failure to observe this caution may result in injury or equipment damage.
- Before starting operation with a machine connected, change the parameter settings to match the parameters of the machine.  
Starting operation without matching the proper settings may cause the machine to run out of control or malfunction.
- Do not turn the power ON and OFF more than necessary.  
Do not use the SERVOPACK for applications that require the power to turn ON and OFF frequently. Such applications will cause elements in the SERVOPACK to deteriorate.  
As a guideline, at least one hour should be allowed between the power being turned ON and OFF once actual operation has been started.
- When carrying out JOG operation (Fn002), origin search (Fn003), or EasyFFT (Fn206), forcing movable machine parts to stop does not work for forward overtravel or reverse overtravel. Take necessary precautions.  
Failure to observe this caution may result in damage to the equipment.
- When using the servomotor for a vertical axis, install safety devices to prevent workpieces from falling due to alarms or overtravels. Set the servomotor so that it will stop in the zero clamp state when overtravel occurs.  
Failure to observe this caution may cause workpieces to fall due to overtravel.
- When not using the turning-less function, set the correct mass ratio (Pn103).  
Setting an incorrect mass ratio may cause machine vibration.
- Do not touch the SERVOPACK heat sinks, regenerative resistor, or servomotor while power is ON or soon after the power is turned OFF.  
Failure to observe this caution may result in burns due to high temperatures.
- Do not make any extreme adjustments or setting changes of parameters.  
Failure to observe this caution may result in injury or damage to the equipment due to unstable operation.
- If an alarm occurs, shut down the main circuit power supply.  
Failure to observe this caution may result in fire due to regenerative resistor overheating caused by regenerative transistor failure.
- When an alarm occurs, remove the cause, reset the alarm after confirming safety, and then resume operation.  
Failure to observe this caution may result in damage to the equipment, fire, or injury.
- An alarm or warning may occur if communications are performed with the host controller while the SigmaWin+ or Digital Operator is operating.  
If an alarm or warning occurs, it may stop the current process and stop the system.

## ■ Maintenance and Inspection

### CAUTION

- Do not disassemble the SERVOPACK and the servomotor.  
Failure to observe this caution may result in electric shock or injury.
- Do not attempt to change wiring while the power is ON.  
Failure to observe this caution may result in electric shock or injury.
- When replacing the SERVOPACK, resume operation only after copying the previous SERVOPACK parameters to the new SERVOPACK.  
Failure to observe this caution may result in damage to the equipment.

---

■ Disposal



**CAUTION**

- When disposing of the products, treat them as ordinary industrial waste.

■ General Precautions

**Observe the following general precautions  
to ensure safe application.**

- The products shown in illustrations in this manual are sometimes shown without covers or protective guards. Always replace the cover or protective guard as specified first, and then operate the products in accordance with the manual.
- The drawings presented in this manual are typical examples and may not match the product you received.
- If the manual must be ordered due to loss or damage, inform your nearest Yaskawa representative or one of the offices listed on the back of this manual.

---

# Warranty

## (1) Details of Warranty

### ■ Warranty Period

The warranty period for a product that was purchased (hereinafter called “delivered product”) is one year from the time of delivery to the location specified by the customer or 18 months from the time of shipment from the Yaskawa factory, whichever is sooner.

### ■ Warranty Scope

Yaskawa shall replace or repair a defective product free of charge if a defect attributable to Yaskawa occurs during the warranty period above. This warranty does not cover defects caused by the delivered product reaching the end of its service life and replacement of parts that require replacement or that have a limited service life.

This warranty does not cover failures that result from any of the following causes.

1. Improper handling, abuse, or use in unsuitable conditions or in environments not described in product catalogs or manuals, or in any separately agreed-upon specifications
2. Causes not attributable to the delivered product itself
3. Modifications or repairs not performed by Yaskawa
4. Abuse of the delivered product in a manner in which it was not originally intended
5. Causes that were not foreseeable with the scientific and technological understanding at the time of shipment from Yaskawa
6. Events for which Yaskawa is not responsible, such as natural or human-made disasters

## (2) Limitations of Liability

1. Yaskawa shall in no event be responsible for any damage or loss of opportunity to the customer that arises due to failure of the delivered product.
2. Yaskawa shall not be responsible for any programs (including parameter settings) or the results of program execution of the programs provided by the user or by a third party for use with programmable Yaskawa products.
3. The information described in product catalogs or manuals is provided for the purpose of the customer purchasing the appropriate product for the intended application. The use thereof does not guarantee that there are no infringements of intellectual property rights or other proprietary rights of Yaskawa or third parties, nor does it construe a license.
4. Yaskawa shall not be responsible for any damage arising from infringements of intellectual property rights or other proprietary rights of third parties as a result of using the information described in catalogs or manuals.

---

### (3) Suitability for Use

1. It is the customer's responsibility to confirm conformity with any standards, codes, or regulations that apply if the Yaskawa product is used in combination with any other products.
2. The customer must confirm that the Yaskawa product is suitable for the systems, machines, and equipment used by the customer.
3. Consult with Yaskawa to determine whether use in the following applications is acceptable. If use in the application is acceptable, use the product with extra allowance in ratings and specifications, and provide safety measures to minimize hazards in the event of failure.
  - Outdoor use, use involving potential chemical contamination or electrical interference, or use in conditions or environments not described in product catalogs or manuals
  - Nuclear energy control systems, combustion systems, railroad systems, aviation systems, vehicle systems, medical equipment, amusement machines, and installations subject to separate industry or government regulations
  - Systems, machines, and equipment that may present a risk to life or property
  - Systems that require a high degree of reliability, such as systems that supply gas, water, or electricity, or systems that operate continuously 24 hours a day
  - Other systems that require a similar high degree of safety
4. Never use the product for an application involving serious risk to life or property without first ensuring that the system is designed to secure the required level of safety with risk warnings and redundancy, and that the Yaskawa product is properly rated and installed.
5. The circuit examples and other application examples described in product catalogs and manuals are for reference. Check the functionality and safety of the actual devices and equipment to be used before using the product.
6. Read and understand all use prohibitions and precautions, and operate the Yaskawa product correctly to prevent accidental harm to third parties.

### (4) Specifications Change

The names, specifications, appearance, and accessories of products in product catalogs and manuals may be changed at any time based on improvements and other reasons. The next editions of the revised catalogs or manuals will be published with updated code numbers. Consult with your Yaskawa representative to confirm the actual specifications before purchasing a product.

## Harmonized Standards

- North American Safety Standards (UL)

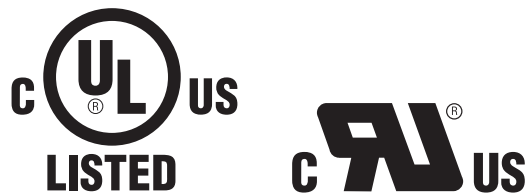

	Model	UL Standards (UL File No.)
SERVOPACK	SGDV	UL508C (E147823)

- European Directives



	Model	European Directives	Harmonized Standards
SERVOPACK	SGDV	Machinery Directive 2006/42/EC	EN ISO13849-1: 2008 EN 954-1
		EMC Directive 2004/108/EC	EN 55011 group1, classA EN 61000-6-2 EN 61800-3
		Low Voltage Directive 2006/95/EC	EN 50178 EN 61800-5-1

- Safety Standards



	Model	Safety Standards	Standards
SERVOPACK	SGDV	Safety of Machinery	EN ISO13849-1: 2008 EN 954-1 IEC 60204-1
		Functional Safety	IEC 61508 series IEC 62061 IEC 61800-5-2
		EMC	IEC 61326-3-1

## ■ Safety Performance

Items	Standards	Performance Level
Safety Integrity Level	IEC 61508	SIL2
	IEC 62061	SILCL2
Probability of Dangerous Failure per Hour	IEC 61508 IEC 62061	PFH = $1.7 \times 10^{-9}$ [1/h] (0.17% of SIL2)
Category	EN 954-1	Category 3
Performance Level	EN ISO 13849-1	PL d (Category 3)
Mean Time to Dangerous Failure of Each Channel	EN ISO 13849-1	MTTFd: High
Average Diagnostic Coverage	EN ISO 13849-1	DCavg: Low
Stop Category	IEC 60204-1	Stop category 0
Safety Function	IEC 61800-5-2	STO
Proof Test Interval	IEC 61508	10 years

# Contents

About this Manual .....	iii
Safety Precautions .....	vii
Warranty .....	xiii
Harmonized Standards .....	xv

## Chapter 1 Outline ..... 1-1

1.1 $\Sigma$ -V Series SERVOPACKs .....	1-2
1.2 SERVOPACKs .....	1-2
1.3 Part Names .....	1-2
1.4 SERVOPACK Ratings and Specifications .....	1-3
1.4.1 Ratings .....	1-3
1.4.2 Basic Specifications .....	1-4
1.5 SERVOPACK Internal Block Diagrams .....	1-7
1.5.1 Single-phase 100 V, SGD V-R70FE5A, -R90FE5A, -2R1FE5A Models .....	1-7
1.5.2 Single-phase 100 V, SGD V-2R8FE5A Model .....	1-8
1.5.3 Three-phase 200 V, SGD V-R70AE5A, -R90AE5A, -1R6AE5A Models .....	1-8
1.5.4 Three-phase 200 V, SGD V-2R8AE5A Model .....	1-9
1.5.5 Three-phase 200 V, SGD V-3R8AE5A, -5R5AE5A, -7R6AE5A Models .....	1-9
1.5.6 Three-phase 200 V, SGD V-120AE5A Model .....	1-10
1.5.7 Three-phase 200 V, SGD V-180AE5A, -200AE5A Models .....	1-10
1.5.8 Three-phase 200 V, SGD V-330AE5A Model .....	1-11
1.5.9 Three-phase 200 V, SGD V-550AE5A Models .....	1-11
1.5.10 Three-phase 400 V, SGD V-1R9DE5A, -3R5DE5A, -5R4DE5A Models .....	1-12
1.5.11 Three-phase 400 V, SGD V-8R4DE5A, -120DE5A Models .....	1-12
1.5.12 Three-phase 400 V, SGD V-170DE5A Model .....	1-13
1.5.13 Three-phase 400 V, SGD V-260DE5A Model .....	1-13
1.6 Examples of Servo System Configurations .....	1-14
1.6.1 Connecting to SGD V-□□□FE5A SERVOPACK .....	1-14
1.6.2 Connecting to SGD V-□□□AE5A SERVOPACK .....	1-15
1.6.3 Connecting to SGD V-□□□DE5A SERVOPACK .....	1-17
1.7 SERVOPACK Model Designation .....	1-18
1.8 Servo Drive Maintenance and Inspection .....	1-19
1.8.1 SERVOPACK Inspection .....	1-19
1.8.2 SERVOPACK's Parts Replacement Schedule .....	1-19
1.8.3 Servomotor Inspection .....	1-20

## Chapter 2 Panel Display and Operation of Digital Operator ..... 2-1

2.1 Panel Display .....	2-2
2.1.1 Status Display .....	2-2
2.1.2 Alarm and Warning Display .....	2-2
2.1.3 Hard Wire Base Block Display .....	2-2
2.1.4 Overtravel Display .....	2-2
2.2 Operation of Digital Operator .....	2-3
2.3 Utility Functions (Fn□□□) .....	2-3
2.4 Parameters (Pn□□□) .....	2-4
2.4.1 Parameter Classification .....	2-4
2.4.2 Notation for Parameters .....	2-4
2.4.3 Setting Parameters .....	2-5
2.5 Monitor Displays (Un□□□) .....	2-7

<b>Chapter 3 Wiring and Connection</b> . . . . .	<b>3-1</b>
3.1 Main Circuit Wiring . . . . .	3-2
3.1.1 Main Circuit Terminals . . . . .	3-2
3.1.2 Using a Standard Power Supply (Single-phase 100 V, Three-phase 200 V, or Three-phase 400 V) . . . . .	3-3
3.1.3 Using the SERVOPACK with Single-phase, 200 V Power Input . . . . .	3-10
3.1.4 Using the SERVOPACK with a DC Power Input . . . . .	3-13
3.1.5 Using More Than One SERVOPACK . . . . .	3-15
3.1.6 General Precautions for Wiring . . . . .	3-16
3.2 I/O Signal Connections . . . . .	3-17
3.2.1 I/O Signal (CN1) Names and Functions . . . . .	3-17
3.2.2 Safety Function Signal (CN8) Names and Functions . . . . .	3-18
3.2.3 Example of I/O Signal Connections . . . . .	3-19
3.3 I/O Signal Allocations . . . . .	3-20
3.3.1 Input Signal Allocations . . . . .	3-20
3.3.2 Output Signal Allocations . . . . .	3-22
3.4 Examples of Connection to Host Controller . . . . .	3-23
3.4.1 Sequence Input Circuit . . . . .	3-23
3.4.2 Sequence Output Circuit . . . . .	3-24
3.5 Wiring Communications Using Command Option Modules . . . . .	3-26
3.6 Linear Scale Connection . . . . .	3-27
3.6.1 Linear Scale Signal (CN2) Names and Functions . . . . .	3-27
3.6.2 Serial Converter Unit . . . . .	3-27
3.6.3 Linear Scale Connection Examples . . . . .	3-30
3.7 Connecting Regenerative Resistors . . . . .	3-34
3.7.1 Connecting Regenerative Resistors . . . . .	3-34
3.7.2 Setting Regenerative Resistor Capacity . . . . .	3-36
3.8 Noise Control and Measures for Harmonic Suppression . . . . .	3-37
3.8.1 Wiring for Noise Control . . . . .	3-37
3.8.2 Precautions on Connecting Noise Filter . . . . .	3-39
3.8.3 Connecting a Reactor for Harmonic Suppression . . . . .	3-40
<b>Chapter 4 Operation</b> . . . . .	<b>4-1</b>
4.1 Option Module Function Settings . . . . .	4-3
4.2 Settings for Common Basic Functions . . . . .	4-4
4.2.1 Inspection and Checking before Operation . . . . .	4-4
4.2.2 Servomotor Movement Direction . . . . .	4-4
4.2.3 Overtravel . . . . .	4-6
4.2.4 Electronic Gear . . . . .	4-9
4.2.5 Encoder Output Pulses . . . . .	4-12
4.2.6 Setting Encoder Output Pulse . . . . .	4-18
4.2.7 Holding Brakes . . . . .	4-19
4.2.8 Stopping Servomotors after Servo OFF Command or Alarm Occurrence . . . . .	4-23
4.2.9 Instantaneous Power Interruption Settings . . . . .	4-25
4.2.10 Motor Maximum Speed . . . . .	4-26
4.2.11 SEMI F47 Function (Force Limit Function for Low DC Power Supply Voltage for Main Circuit) . . . . .	4-26
4.2.12 Setting Motor Overload Detection Level . . . . .	4-29
4.3 Test Without Motor Function . . . . .	4-31
4.3.1 Motor Information . . . . .	4-31
4.3.2 Motor Position and Speed Responses . . . . .	4-32
4.3.3 Limitations . . . . .	4-32
4.3.4 Digital Operator Displays during Testing without Motor . . . . .	4-33
4.4 Limiting Force . . . . .	4-34
4.4.1 Internal Force Limit . . . . .	4-34
4.4.2 External Force Limit . . . . .	4-35
4.4.3 Checking Output Force Limiting during Operation . . . . .	4-36

4.5	Absolute Linear Scales	4-37
4.5.1	Absolute Data Request (Sensor ON Command)	4-37
4.5.2	Absolute Data Reception Sequence	4-38
4.6	Other Output Signals	4-41
4.6.1	Servo Alarm Output Signal (ALM)	4-41
4.6.2	Warning Output Signal (/WARN)	4-41
4.6.3	Movement Detection Output Signal (/TGON)	4-42
4.6.4	Servo Ready Output Signal (/S-RDY)	4-42
4.6.5	Speed Coincidence Output Signal (/V-CMP)	4-43
4.6.6	Positioning Completed Output Signal (/COIN)	4-44
4.6.7	Positioning Near Output Signal (/NEAR)	4-45
4.6.8	Speed Limit Detection Signal (/VLT)	4-46
4.7	Safety Function	4-48
4.7.1	Hard Wire Base Block (HWBB) Function	4-48
4.7.2	External Device Monitor (EDM1)	4-53
4.7.3	Application Example of Safety Functions	4-55
4.7.4	Confirming Safety Functions	4-56
4.7.5	Safety Device Connections	4-57
4.7.6	Precautions for Safety Functions	4-58
<b>Chapter 5 Adjustments</b>		<b>5-1</b>
5.1	Type of Adjustments and Basic Adjustment Procedure	5-3
5.1.1	Adjustments	5-3
5.1.2	Basic Adjustment Procedure	5-4
5.1.3	Monitoring Operation during Adjustment	5-5
5.1.4	Safety Precautions on Adjustment of Servo Gains	5-8
5.2	Tuning-less Function	5-10
5.2.1	Tuning-less Function	5-10
5.2.2	Tuning-less Levels Setting (Fn200) Procedure	5-12
5.2.3	Related Parameters	5-14
5.3	Advanced Autotuning (Fn201)	5-15
5.3.1	Advanced Autotuning	5-15
5.3.2	Advanced Autotuning Procedure	5-18
5.3.3	Related Parameters	5-24
5.4	Advanced Autotuning by Reference (Fn202)	5-25
5.4.1	Advanced Autotuning by Reference	5-25
5.4.2	Advanced Autotuning by Reference Procedure	5-27
5.4.3	Related Parameters	5-31
5.5	One-parameter Tuning (Fn203)	5-32
5.5.1	One-parameter Tuning	5-32
5.5.2	One-parameter Tuning Procedure	5-33
5.5.3	One-parameter Tuning Example	5-39
5.5.4	Related Parameters	5-41
5.6	Anti-Resonance Control Adjustment Function (Fn204)	5-42
5.6.1	Anti-Resonance Control Adjustment Function	5-42
5.6.2	Anti-Resonance Control Adjustment Function Operating Procedure	5-43
5.6.3	Related Parameters	5-47
5.7	Vibration Suppression Function (Fn205)	5-48
5.7.1	Vibration Suppression Function	5-48
5.7.2	Vibration Suppression Function Operating Procedure	5-49
5.7.3	Related Parameters	5-52
5.8	Additional Adjustment Function	5-53
5.8.1	Switching Gain Settings	5-53
5.8.2	Manual Adjustment of Friction Compensation	5-57
5.8.3	Current Control Mode Selection Function	5-59
5.8.4	Current Gain Level Setting	5-59
5.8.5	Speed Detection Method Selection	5-59

5.9 Compatible Adjustment Function . . . . .	5-60
5.9.1 Feedforward Reference . . . . .	5-60
5.9.2 Mode Switch (P/PI Switching) . . . . .	5-61
5.9.3 Force Reference Filter . . . . .	5-63
5.9.4 Position Integral . . . . .	5-65

## Chapter 6 Utility Functions (Fn□□□) . . . . . 6-1

6.1 List of Utility Functions . . . . .	6-2
6.2 Alarm History Display (Fn000) . . . . .	6-3
6.3 JOG Operation (Fn002) . . . . .	6-4
6.4 Origin Search (Fn003) . . . . .	6-6
6.5 Program JOG Operation (Fn004) . . . . .	6-8
6.6 Initializing Parameter Settings (Fn005) . . . . .	6-12
6.7 Clearing Alarm History (Fn006) . . . . .	6-13
6.8 Offset Adjustment of Analog Monitor Output (Fn00C) . . . . .	6-14
6.9 Gain Adjustment of Analog Monitor Output (Fn00D) . . . . .	6-16
6.10 Automatic Offset-Signal Adjustment of the Motor Current Detection Signal (Fn00E) . . . . .	6-18
6.11 Manual Offset-Signal Adjustment of the Motor Current Detection Signal (Fn00F) . . . . .	6-19
6.12 Write Prohibited Setting (Fn010) . . . . .	6-21
6.13 Servomotor Model Display (Fn011) . . . . .	6-23
6.14 Software Version Display (Fn012) . . . . .	6-24
6.15 Resetting Configuration Errors in Option Modules (Fn014) . . . . .	6-25
6.16 Vibration Detection Level Initialization (Fn01B) . . . . .	6-26
6.17 Display of SERVOPACK and Servomotor ID (Fn01E) . . . . .	6-28
6.18 Origin Setting (Fn020) . . . . .	6-30
6.19 Software Reset (Fn030) . . . . .	6-31
6.20 Polarity Detection (Fn080) . . . . .	6-32
6.21 EasyFFT (Fn206) . . . . .	6-33
6.22 Online Vibration Monitor (Fn207) . . . . .	6-36

## Chapter 7 Monitor Displays (Un□□□) . . . . . 7-1

7.1 List of Monitor Displays . . . . .	7-2
7.2 Viewing Monitor Displays . . . . .	7-3
7.3 Monitoring Input Signals . . . . .	7-4
7.3.1 Interpreting Input Signal Display Status . . . . .	7-4
7.3.2 Input Signal Display Example . . . . .	7-5
7.4 Monitoring Output Signals . . . . .	7-6
7.4.1 Interpreting Output Signal Display Status . . . . .	7-6
7.4.2 Output Signal Display Example . . . . .	7-6
7.5 Monitoring Safety Input Signals . . . . .	7-7
7.5.1 Interpreting Safety Input Signal Display Status . . . . .	7-7
7.5.2 Safety Input Signal Display Example . . . . .	7-7

---

Chapter 8 Troubleshooting . . . . .	8-1
8.1 Alarm Displays . . . . .	8-2
8.1.1 List of Alarms . . . . .	8-2
8.1.2 Troubleshooting of Alarms . . . . .	8-7
8.2 Warning Displays . . . . .	8-25
8.2.1 List of Warnings . . . . .	8-25
8.2.2 Troubleshooting of Warnings . . . . .	8-26
8.3 Troubleshooting Malfunction Based on Operation and Conditions of the Servomotor . . . . .	8-30

Chapter 9 Appendix. . . . .	9-1
9.1 List of Parameters . . . . .	9-2
9.2 Parameter Recording Table . . . . .	9-22

Index. . . . .	Index-1
----------------	---------

Revision History

## Outline

1.1 $\Sigma$ -V Series SERVOPACKs .....	1-2
1.2 SERVOPACKs .....	1-2
1.3 Part Names .....	1-2
1.4 SERVOPACK Ratings and Specifications .....	1-3
1.4.1 Ratings .....	1-3
1.4.2 Basic Specifications .....	1-4
1.5 SERVOPACK Internal Block Diagrams .....	1-7
1.5.1 Single-phase 100 V, SGD V-R70FE5A, -R90FE5A, -2R1FE5A Models .....	1-7
1.5.2 Single-phase 100 V, SGD V-2R8FE5A Model .....	1-8
1.5.3 Three-phase 200 V, SGD V-R70AE5A, -R90AE5A, -1R6AE5A Models .....	1-8
1.5.4 Three-phase 200 V, SGD V-2R8AE5A Model .....	1-9
1.5.5 Three-phase 200 V, SGD V-3R8AE5A, -5R5AE5A, -7R6AE5A Models .....	1-9
1.5.6 Three-phase 200 V, SGD V-120AE5A Model .....	1-10
1.5.7 Three-phase 200 V, SGD V-180AE5A, -200AE5A Models .....	1-10
1.5.8 Three-phase 200 V, SGD V-330AE5A Model .....	1-11
1.5.9 Three-phase 200 V, SGD V-550AE5A Models .....	1-11
1.5.10 Three-phase 400 V, SGD V-1R9DE5A, -3R5DE5A, -5R4DE5A Models .....	1-12
1.5.11 Three-phase 400 V, SGD V-8R4DE5A, -120DE5A Models .....	1-12
1.5.12 Three-phase 400 V, SGD V-170DE5A Model .....	1-13
1.5.13 Three-phase 400 V, SGD V-260DE5A Model .....	1-13
1.6 Examples of Servo System Configurations .....	1-14
1.6.1 Connecting to SGD V-□□□FE5A SERVOPACK .....	1-14
1.6.2 Connecting to SGD V-□□□AE5A SERVOPACK .....	1-15
1.6.3 Connecting to SGD V-□□□DE5A SERVOPACK .....	1-17
1.7 SERVOPACK Model Designation .....	1-18
1.8 Servo Drive Maintenance and Inspection .....	1-19
1.8.1 SERVOPACK Inspection .....	1-19
1.8.2 SERVOPACK's Parts Replacement Schedule .....	1-19
1.8.3 Servomotor Inspection .....	1-20

## 1.1 Σ-V Series SERVOPACKs

The Σ-V Series SERVOPACKs are designed for applications that require frequent high-speed, high-precision positioning. The SERVOPACK makes the most of machine performance in the shortest time possible, thus contributing to improving productivity.

## 1.2 SERVOPACKs

The command option attachable type SERVOPACK is used with command option modules. For reference methods, I/O signals, and other operations, refer to the manual for the command option module that is connected.

## 1.3 Part Names

This section describes the part names of an SGD-V Command Option-attachable SERVOPACK.

### CN5 Analog monitor connector

Used to monitor motor speed, force reference, and other values through a special cable (option).  
Refer to 5.1.3 *Monitoring Operation during Adjustment*.

### Serial number

Rotary switch (SW 1)  
Refer to the manual for the connected command option module.

### DIP switch (SW 2)

Refer to the manual for the connected command option module.

With front cover open

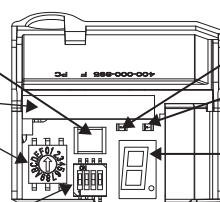

### Power LED indicator (POWER)

Indicates that the control power is being supplied.

### Communications LED indicator (COM)

Not used. Normally OFF.

### Panel display

Indicates the servo status with a seven-segment LED display.  
Refer to 2.1.1 *Status Display*.

### Nameplate (Found on side of SERVOPACK.)

Indicates the SERVOPACK model and ratings.

### Charge indicator

Lights when the main circuit power supply is ON and stays lit as long as the internal capacitor remains charged. Therefore, do not touch the SERVOPACK even after the power supply is turned OFF if the indicator is lit. It may result in electric shock.

### Main circuit power supply terminals

Used for main circuit power supply input.  
Refer to 3.1 *Main Circuit Wiring*.

### Control power supply terminals

Used for control power supply input.  
Refer to 3.1 *Main Circuit Wiring*.

### Regenerative resistor connecting terminals

Connects external regenerative resistors.  
Refer to 3.7 *Connecting Regenerative Resistors*.

### DC reactor terminals for harmonic suppression

Connects DC reactor for harmonic suppression.  
Refer to 3.8.3 *Connecting a Reactor for Harmonic Suppression*.

### Servomotor terminals

Connects the main circuit cable for servomotor.  
Refer to 3.1 *Main Circuit Wiring*.

### Ground terminal

Be sure to connect to protect against electrical shock.  
Refer to 3.1 *Main Circuit Wiring*.

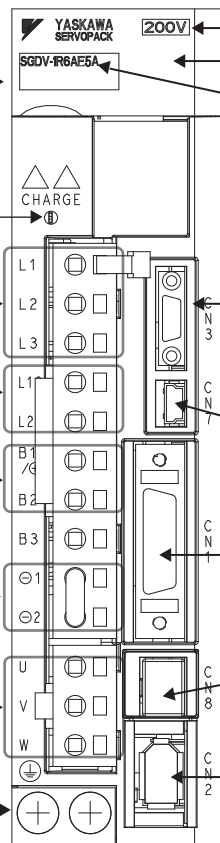

### Input voltage

### Front cover

### SERVOPACK model

Refer to 1.7 *SERVOPACK Model Designation*.

### CN3 Connector for digital operator

Connects a digital operator (option, model: JUSP-OP05A-1-E) or a personal computer (RS422).  
Refer to Σ-V Series *Product Catalog* (No.: KAEP S800000 42) and Σ-V Series *User's Manual, Operation of Digital Operator* (No.: SIEP S800000 55).

### CN7 Connector for personal computer (USB connector)

Communicates with a personal computer. Use the connection cable (model: JZSP-CVS06-02-E).

### CN1 I/O signal connector

Used to connect sequence I/O signals.  
Refer to 3.2 *I/O Signal Connections*.

### CN8 Connector for safety function devices

Connects a safety function device.  
Note: When not using a safety function device, use the SERVOPACK with the safety function's jumper connector inserted (the factory default state). For the connecting method, refer to 3.2.2 *Safety Function Signal (CN8) Names and Functions*. For details on how to use the safety function, refer to 4.7 *Safety Function*.

### CN2 Linear scale connector

Connects a serial converter unit or a linear scale.  
Refer to 3.6 *Linear Scale Connection*.

## 1.4 SERVOPACK Ratings and Specifications

This section describes the ratings and specifications of SERVOPACKs.

### 1.4.1 Ratings

Ratings of SERVOPACKs are as shown below.

#### (1) SGDV with Single-phase, 100-V Rating

SGDV (Single Phase, 100 V)	R70	R90	2R1	2R8
Continuous Output Current [Arms]	0.66	0.91	2.1	2.8
Instantaneous Max. Output Current [Arms]	2.1	2.9	6.5	9.3
Regenerative Resistor *	None or external			
Main Circuit Power Supply	Single-phase, 100 to 115 VAC, +10% to -15%, 50/60 Hz			
Control Power Supply	Single-phase, 100 to 115 VAC, +10% to -15%, 50/60 Hz			
Overvoltage Category	III			

\* Refer to 3.7 *Connecting Regenerative Resistors* for details.

#### (2) SGDV with Three-phase, 200-V Rating

SGDV (Three Phase, 200 V)	R70	R90	1R6	2R8	3R8	5R5	7R6	120	180	200	330	550
Continuous Output Current [Arms]	0.66	0.91	1.6	2.8	3.8	5.5	7.6	11.6	18.5	19.6	32.9	54.7
Instantaneous Max. Output Current [Arms]	2.1	2.9	5.8	9.3	11.0	16.9	17	28	42	56	84	130
Regenerative Resistor *	None or external						Built-in or external					External
Main Circuit Power Supply	Three-phase, 200 to 230 VAC, +10% to -15%, 50/60 Hz											
Control Power Supply	Single-phase, 200 to 230 VAC, +10% to -15%, 50/60 Hz											
Overvoltage Category	III											

\* Refer to 3.7 *Connecting Regenerative Resistors* for details.

#### (3) SGDV with Three-phase, 400-V Rating

SGDV (Three Phase, 400 V)	1R9	3R5	5R4	8R4	120	170	260
Continuous Output Current [Arms]	1.9	3.5	5.4	8.4	11.9	16.5	25.7
Instantaneous Max. Output Current [Arms]	5.5	8.5	14	20	28	42	65
Regenerative Resistor *	Built-in or external						External
Main Circuit Power Supply	Three-phase, 380 to 480 VAC, +10% to -15%, 50/60 Hz						
Control Power Supply	24 VDC $\pm$ 15%						
Overvoltage Category	III						

\* Refer to 3.7 *Connecting Regenerative Resistors* for details.

## 1.4.2 Basic Specifications

Basic specifications of SERVOPACKs are shown below.

Drive Method		Sine-wave current drive with PWM control of IGBT	
Feedback		<ul style="list-style-type: none"> <li>Absolute linear scale  <math display="block">\text{Signal resolution}^{*1} = \frac{\text{Linear scale pitch of absolute linear scale}}{\text{Number of divisions on absolute linear scale}}</math> </li> <li>Incremental linear scale  <math display="block">\text{Signal resolution}^{*2} = \frac{\text{Linear scale pitch of incremental linear scale}}{\text{Number of divisions on serial converter unit}}</math> </li> </ul>	
Operating Conditions	Ambient Operating Temperature	0°C to +55°C	
	Storage Temperature	-20°C to +85°C	
	Ambient Humidity	90% RH or less	With no freezing or condensation
	Storage Humidity	90% RH or less	
	Vibration Resistance	4.9 m/s <sup>2</sup>	
	Shock Resistance	19.6 m/s <sup>2</sup>	
	Protection Class	IP10	An environment that satisfies the following conditions. <ul style="list-style-type: none"> <li>Free of corrosive or flammable gases</li> <li>Free of exposure to water, oil, or chemicals</li> <li>Free of dust, salts, or iron dust</li> </ul>
	Pollution Degree	2	
	Altitude	1000 m or less	
	Others	Free of static electricity, strong electromagnetic fields, magnetic fields or exposure to radioactivity	
Harmonized Standards		UL508C EN 50178, EN 55011 Group 1 class A, EN 61000-6-2, EN 61800-3, EN 61800-5-1, EN 954-1, and IEC 61508-1 to 61508-4	
Mounting		Standard: Base-mounted Optional: Rack-mounted or duct-ventilated	
Performance	Speed Control Range		1:5000 (The lower limit of the speed control range must be lower than the point at which the rated force does not cause the servomotor to stop.)
	Speed Regulation <sup>*3</sup>	Load Regulation	0% to 100% load: ±0.01% max. (at rated speed)
		Voltage Regulation	Rated voltage ±10%: 0% (at rated speed)
		Temperature Regulation	25 ± 25°C: ±0.1% max. (at rated speed)
Force Control Tolerance (Repeatability)		±1%	

(cont'd)

I/O Signals	Encoder Output Pulse		Phase A, B, C: line driver Encoder output pulse: any setting ratio (Refer to 4.2.6.)		
	Sequence Input	Input Signals which can be allocated	Number of Channels	7 ch	
			Functions	<ul style="list-style-type: none"> <li>• Forward run prohibited (P-OT), reverse run prohibited (N-OT)</li> <li>• Forward external force limit (/P-CL), reverse external force limit (/N-CL)</li> <li>• General-purpose input signal (/SI0 to /SI6)<sup>*4</sup></li> </ul> Signal allocations can be performed, and positive and negative logic can be changed.	
	Sequence Output	Output Signals which can be allocated	Fixed Output	Servo alarm (ALM) output	
			Functions	<ul style="list-style-type: none"> <li>• Positioning completion (/COIN)</li> <li>• Speed coincidence detection (/V-CMP)</li> <li>• Movement detection (/TGON)</li> <li>• Servo ready (/S-RDY)</li> <li>• Force limit detection (/CLT)</li> <li>• Speed limit detection (/VLT)</li> <li>• Brake (/BK)</li> <li>• Warning (/WARN)</li> <li>• Near (/NEAR)</li> <li>• General-purpose input signal (/SO1 to /SO3)<sup>*4</sup></li> </ul> Signal allocations can be performed, and positive and negative logic can be changed.	
	Communications Function	RS422A Communications (CN3)	Interface	Digital operator (model: JUSP-OP05A-1-E) Personal computer (can be connected with SigmaWin+)	
1:N Communications			N = Up to 15 stations possible at RS422A		
Axis Address Setting			Set by parameter		
USB Communications (CN7)		Interface	Personal computer (can be connected with SigmaWin+)		
	Communications Standard	Complies with standard USB1.1. (12 Mbps)			
LED Display			Panel display (seven-segment), CHARGE, POWER, and COM indicators		
Analog Monitor (CN5)			Number of points: 2 Output voltage: ± 10VDC (linearity effective range ± 8 V) Resolution: 16 bits Accuracy: ± 20 mV (Typ) Max. output current: ± 10 mA Settling time (± 1%): 1.2 ms (Typ)		
Dynamic Brake (DB)			Activated when a servo alarm or overtraveling occurs or when the power supply for the main circuit or servomotor is OFF.		
Regenerative Processing			Included <sup>*5</sup>		
Overtravel Prevention (OT)			Dynamic brake stop, deceleration to a stop, or free run to a stop at P-OT or N-OT		
Protective Function			Overcurrent, overvoltage, insufficient voltage, overload, regeneration error, and so on.		
Utility Function			Gain adjustment, alarm history, JOG operation, origin search, and so on.		
Safety Function	Input	/HWBB1, /HWBB2: Baseblock signal for power module			
	Output	EDM1: Monitoring status of internal safety circuit (fixed output)			
	Standards <sup>*6</sup>	EN954 Category 3, IEC61508 SIL2			

(cont'd)

Option Module	Fully-closed module, safety module, or command option module
<ul style="list-style-type: none"><li>*1. The signal resolution depends on the absolute linear scale being used. For details, refer to <i>4.2.4 Electronic Gear</i>.</li><li>*2. The signal resolution depends on the serial converter unit and linear scale being used. For details, refer to <i>3.6.2 Serial Converter Unit</i> and <i>4.2.4 Electronic Gear</i>.</li><li>*3. Speed regulation by load regulation is defined as follows: <math display="block">\text{Speed regulation} = \frac{\text{No-load motor speed} - \text{Total load motor speed}}{\text{Rated motor speed}} \times 100\%</math></li><li>*4. For information on the functions, refer to the manual of the connected command option module.</li><li>*5. Refer to <i>1.4.1 Ratings</i> for details on regenerative resistors.</li><li>*6. Perform risk assessment for the system and be sure that the safety requirements are fulfilled.</li></ul>	

## 1.5 SERVOPACK Internal Block Diagrams

### 1.5.1 Single-phase 100 V, SGDV-R70FE5A, -R90FE5A, -2R1FE5A Models

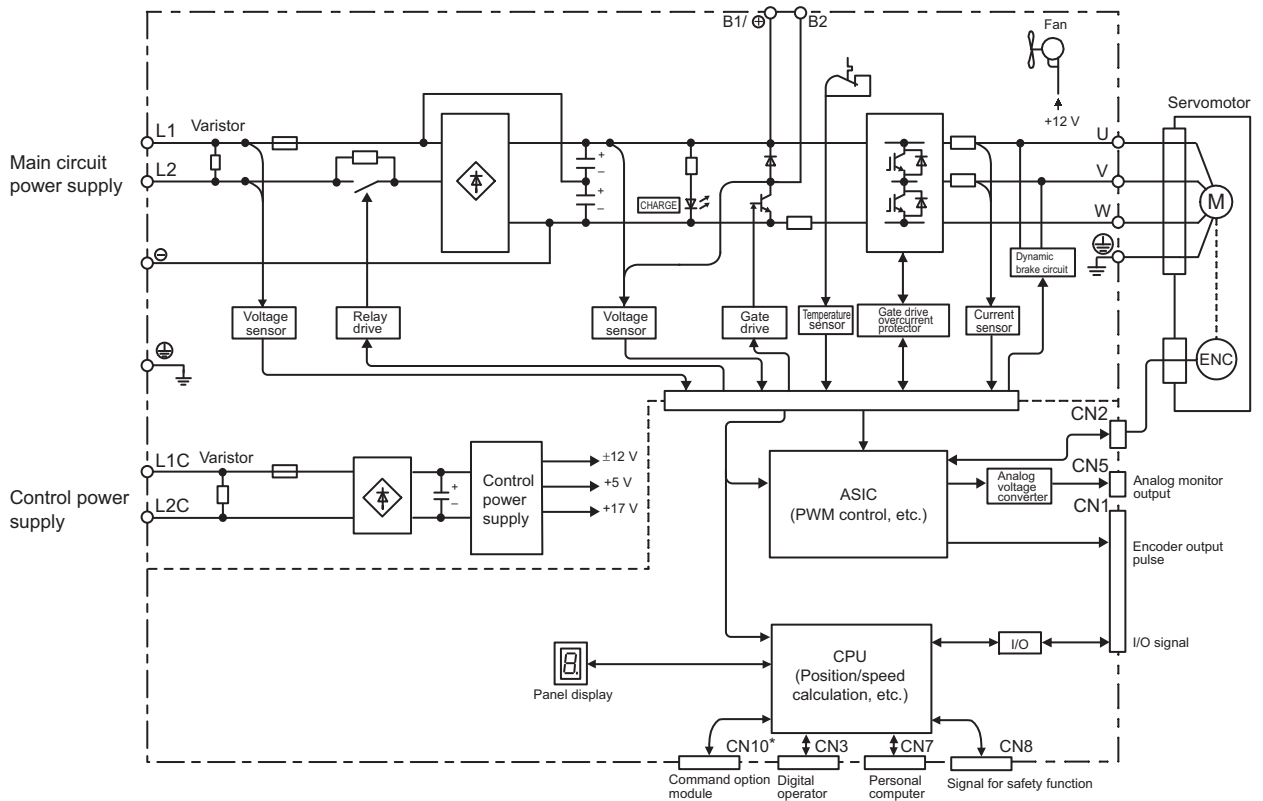

\* This external input signal is used by the option module.  
For details, refer to the manual of the connected option module.

### 1.5.2 Single-phase 100 V, SGDV-2R8FE5A Model

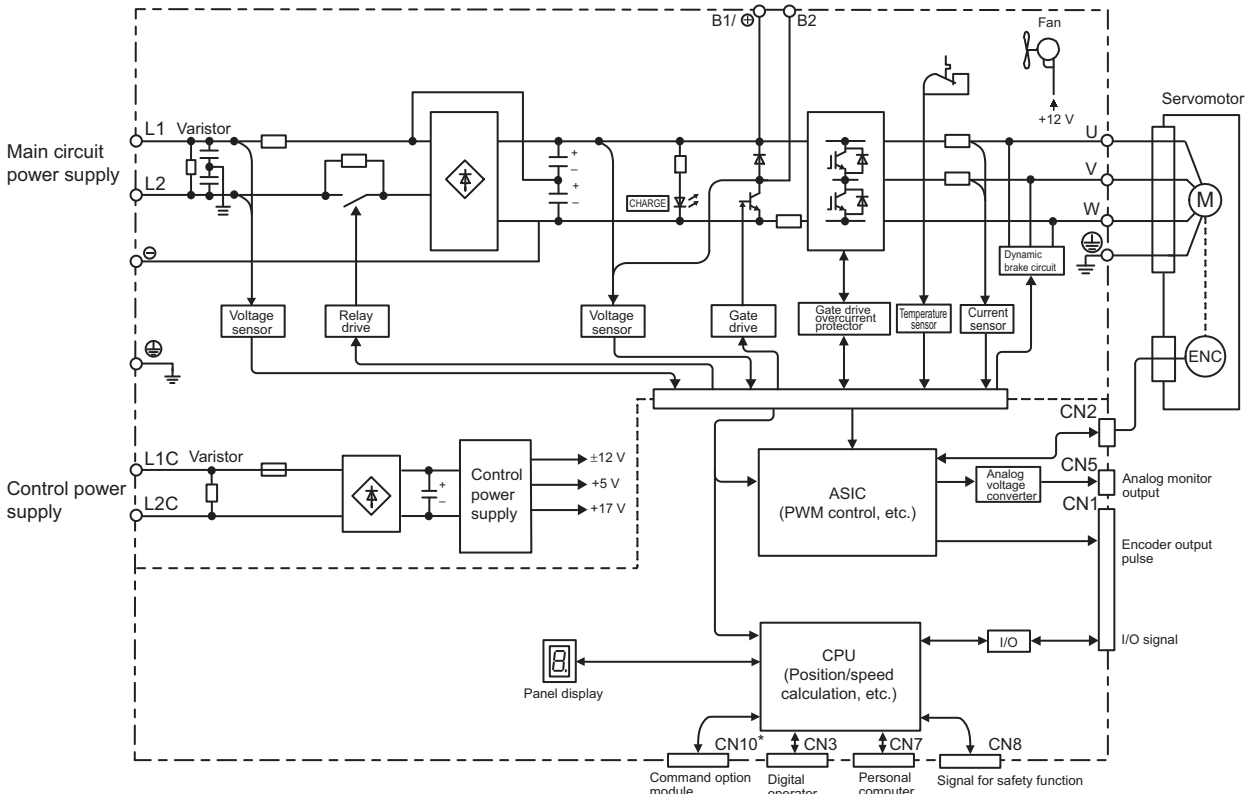

\* This external input signal is used by the option module.  
For details, refer to the manual of the connected option module.

### 1.5.3 Three-phase 200 V, SGDV-R70AE5A, -R90AE5A, -1R6AE5A Models

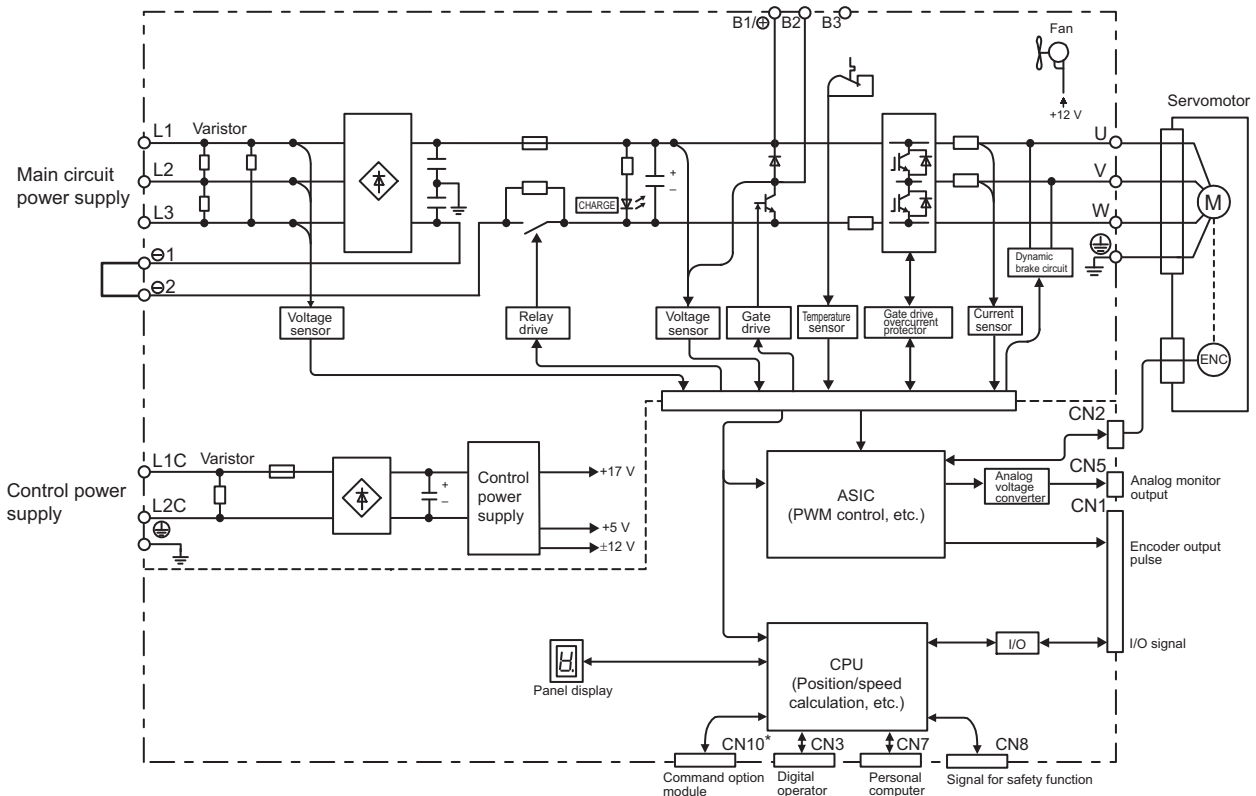

\* This external input signal is used by the option module.  
For details, refer to the manual of the connected option module.

### 1.5.4 Three-phase 200 V, SGDV-2R8AE5A Model

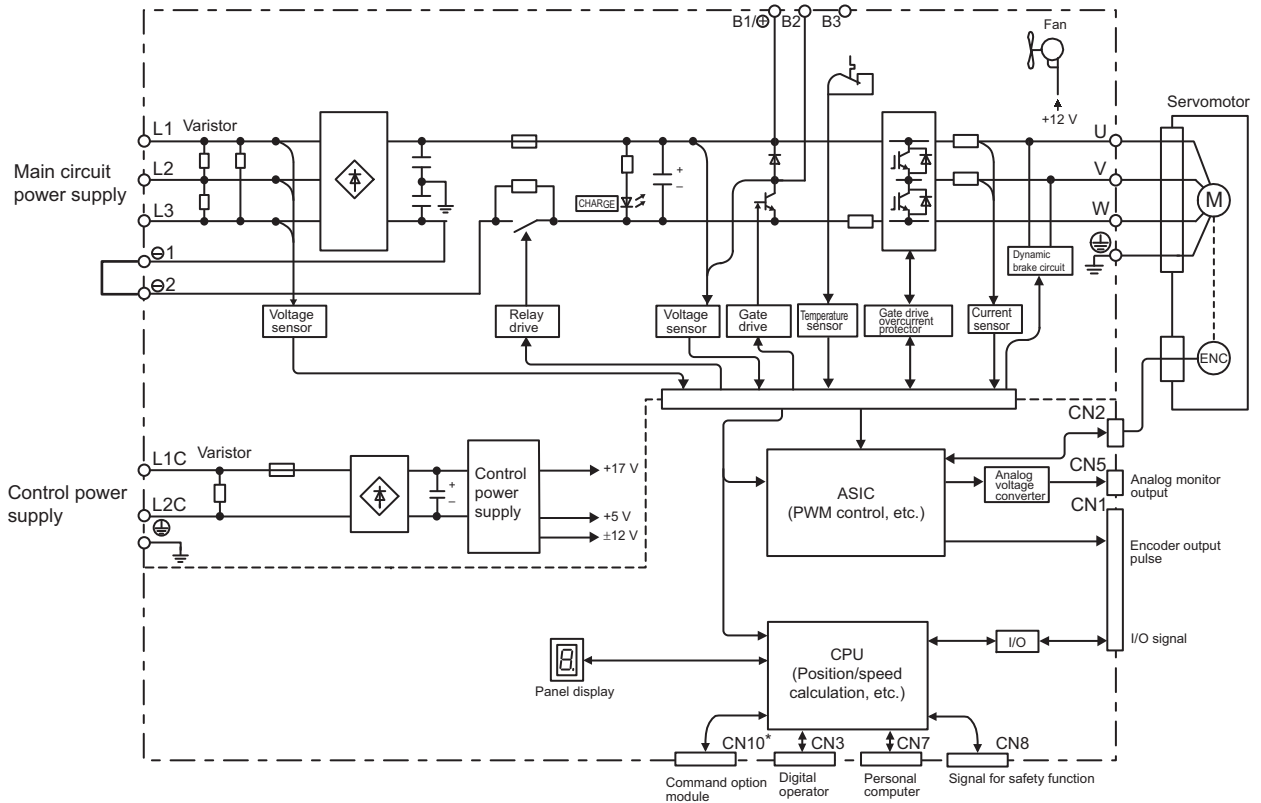

\* This external input signal is used by the option module.  
For details, refer to the manual of the connected option module.

### 1.5.5 Three-phase 200 V, SGDV-3R8AE5A, -5R5AE5A, -7R6AE5A Models

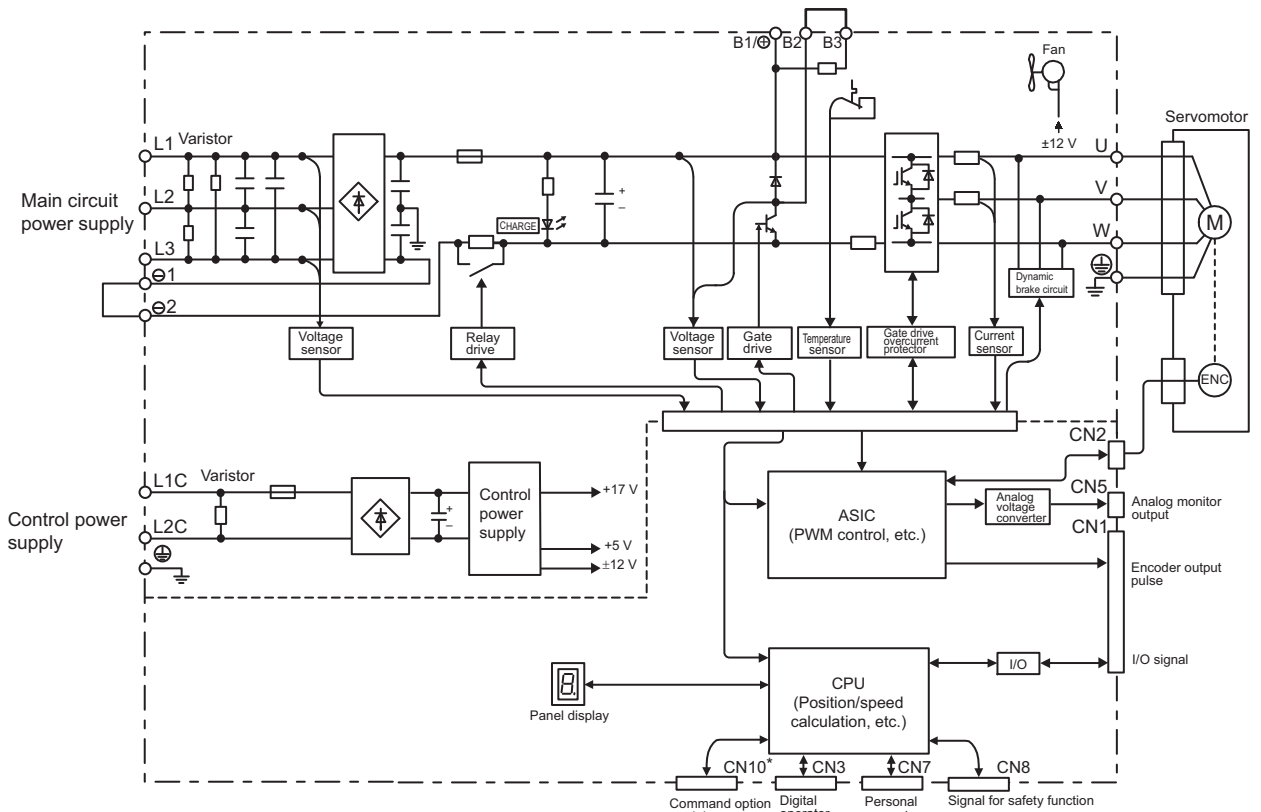

\* This external input signal is used by the option module.  
For details, refer to the manual of the connected option module.

### 1.5.6 Three-phase 200 V, SGDV-120AE5A Model

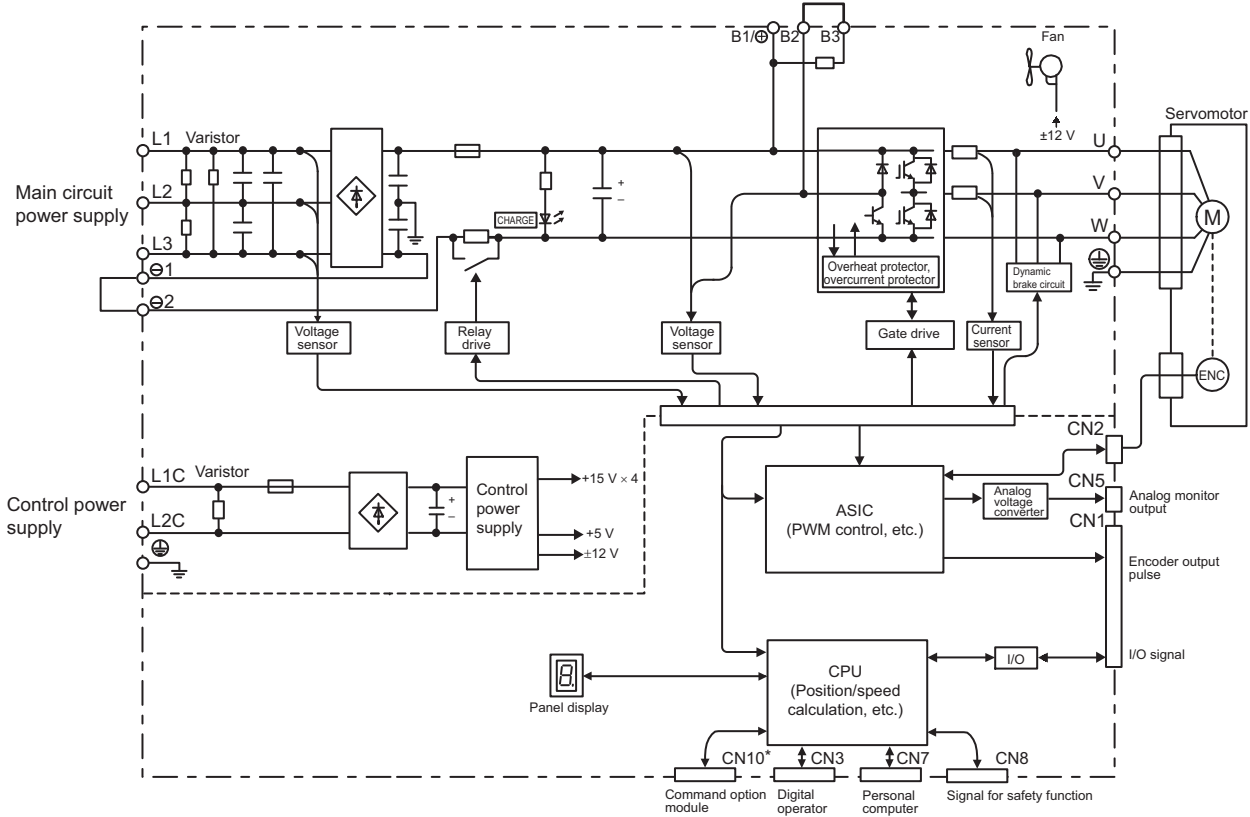

\* This external input signal is used by the option module.  
For details, refer to the manual of the connected option module.

### 1.5.7 Three-phase 200 V, SGDV-180AE5A, -200AE5A Models

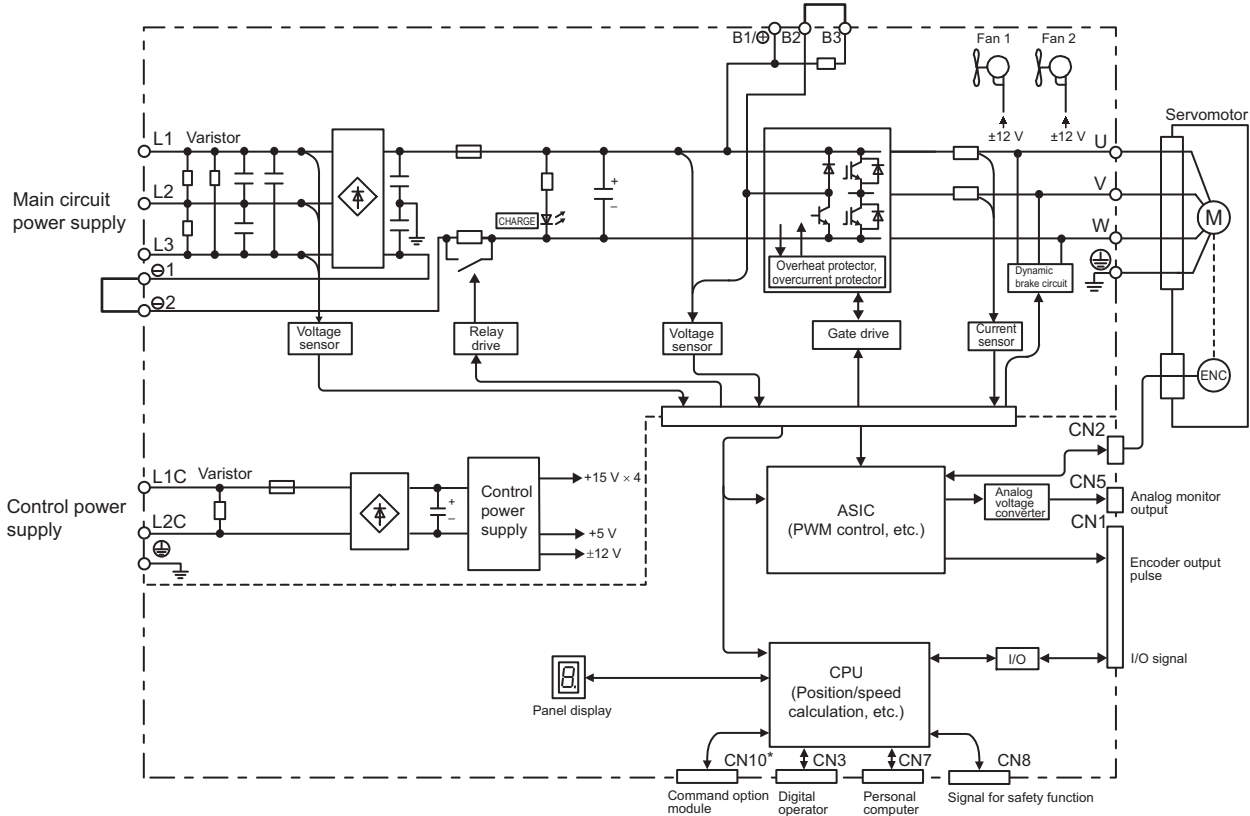

\* This external input signal is used by the option module.  
For details, refer to the manual of the connected option module.

### 1.5.8 Three-phase 200 V, SGDV-330AE5A Model

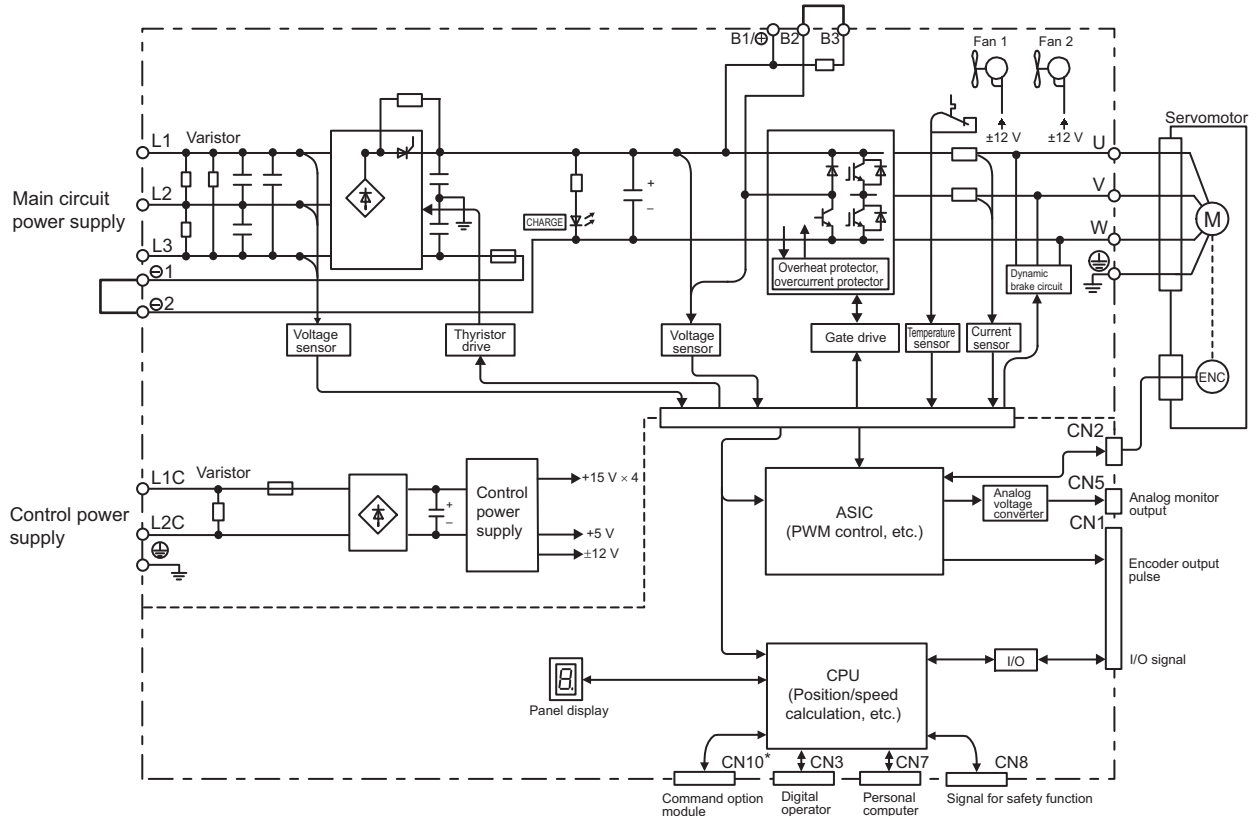

\* This external input signal is used by the option module.  
For details, refer to the manual of the connected option module.

### 1.5.9 Three-phase 200 V, SGDV-550AE5A Models

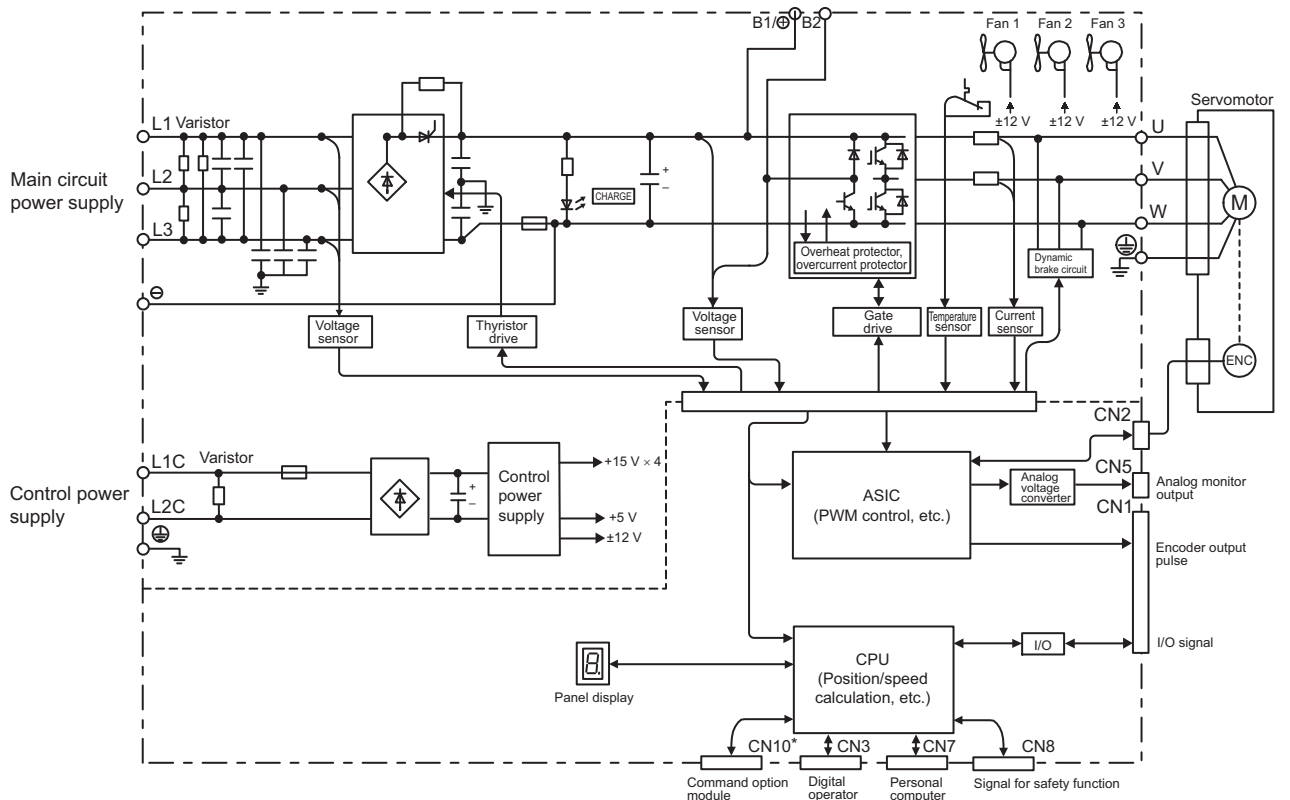

\* This external input signal is used by the option module.  
For details, refer to the manual of the connected option module.

**1.5.10 Three-phase 400 V, SGDV-1R9DE5A, -3R5DE5A, -5R4DE5A Models**

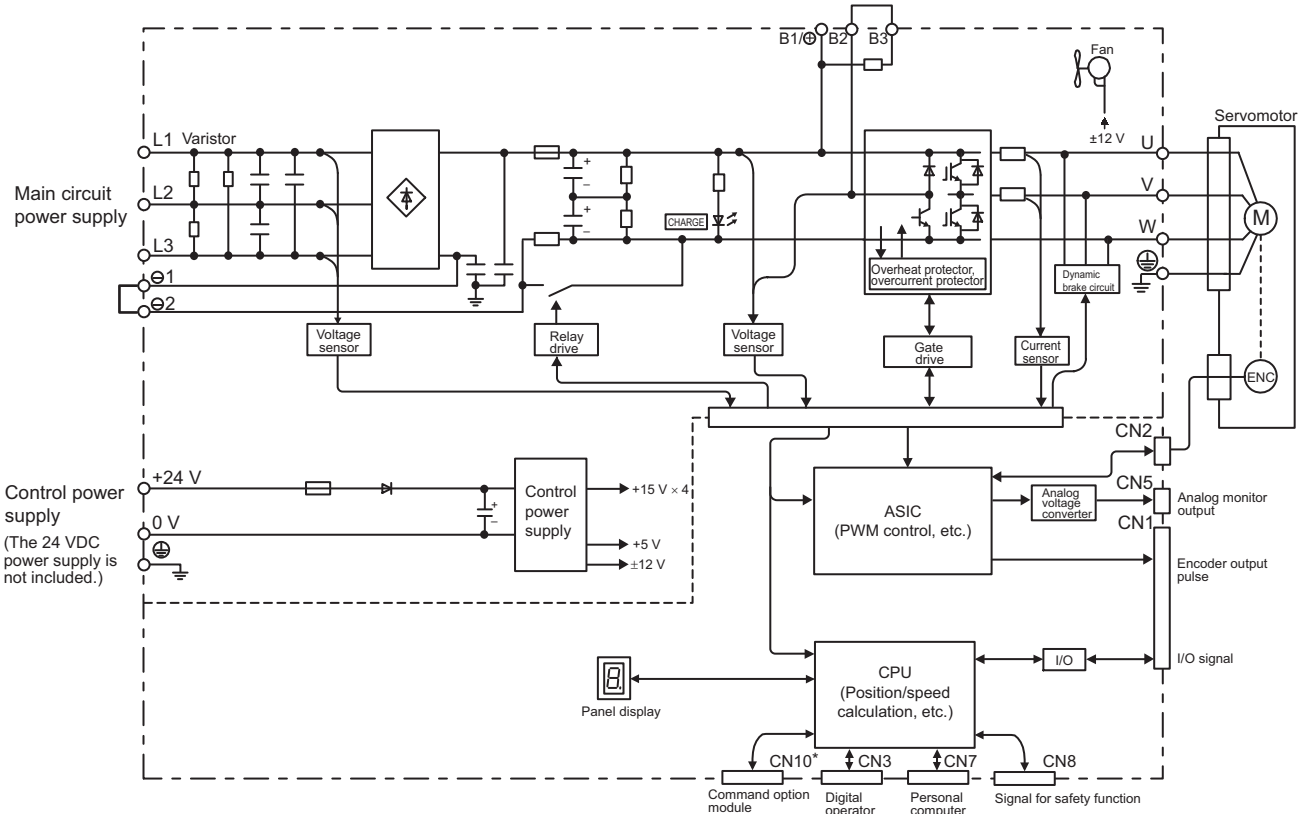

\* This external input signal is used by the option module.  
For details, refer to the manual of the connected option module.

**1.5.11 Three-phase 400 V, SGDV-8R4DE5A, -120DE5A Models**

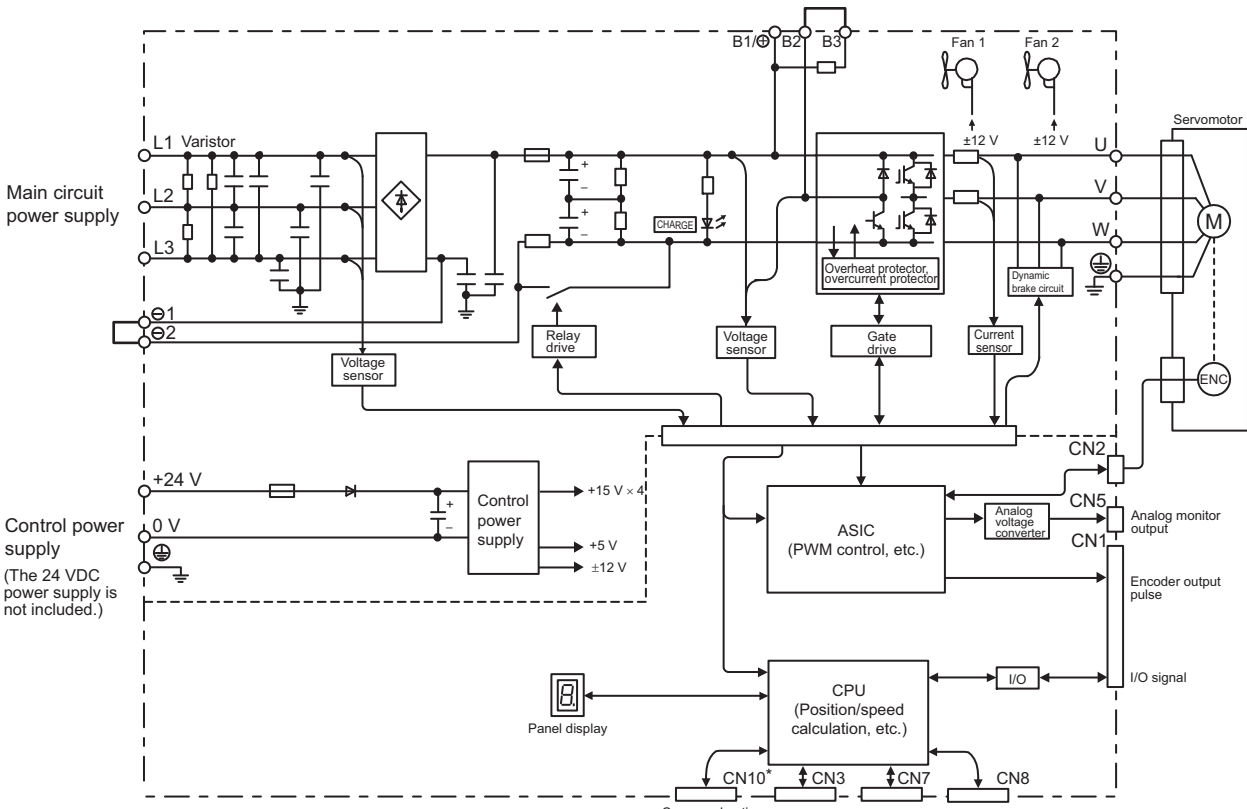

\* This external input signal is used by the option module.  
For details, refer to the manual of the connected option module.

### 1.5.12 Three-phase 400 V, SGDV-170DE5A Model

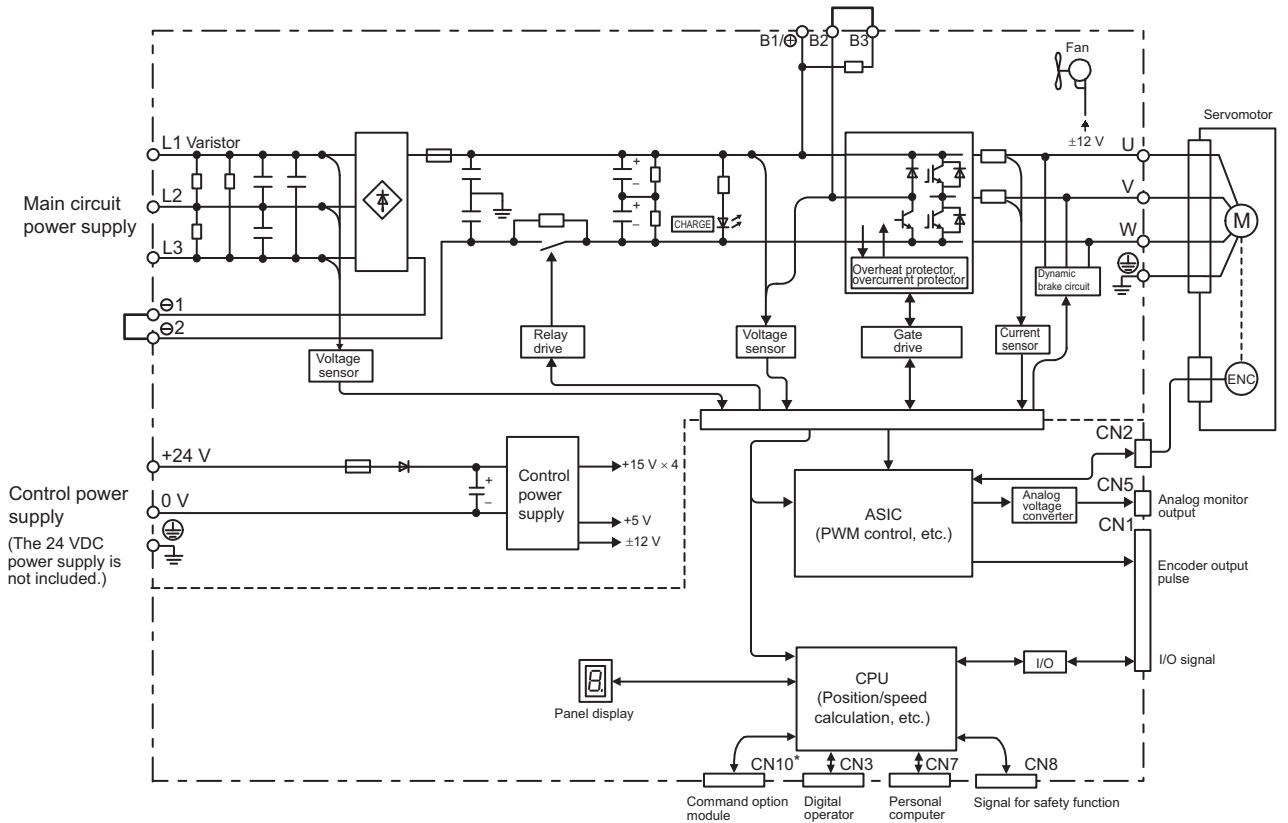

\* This external input signal is used by the option module.  
For details, refer to the manual of the connected option module.

### 1.5.13 Three-phase 400 V, SGDV-260DE5A Model

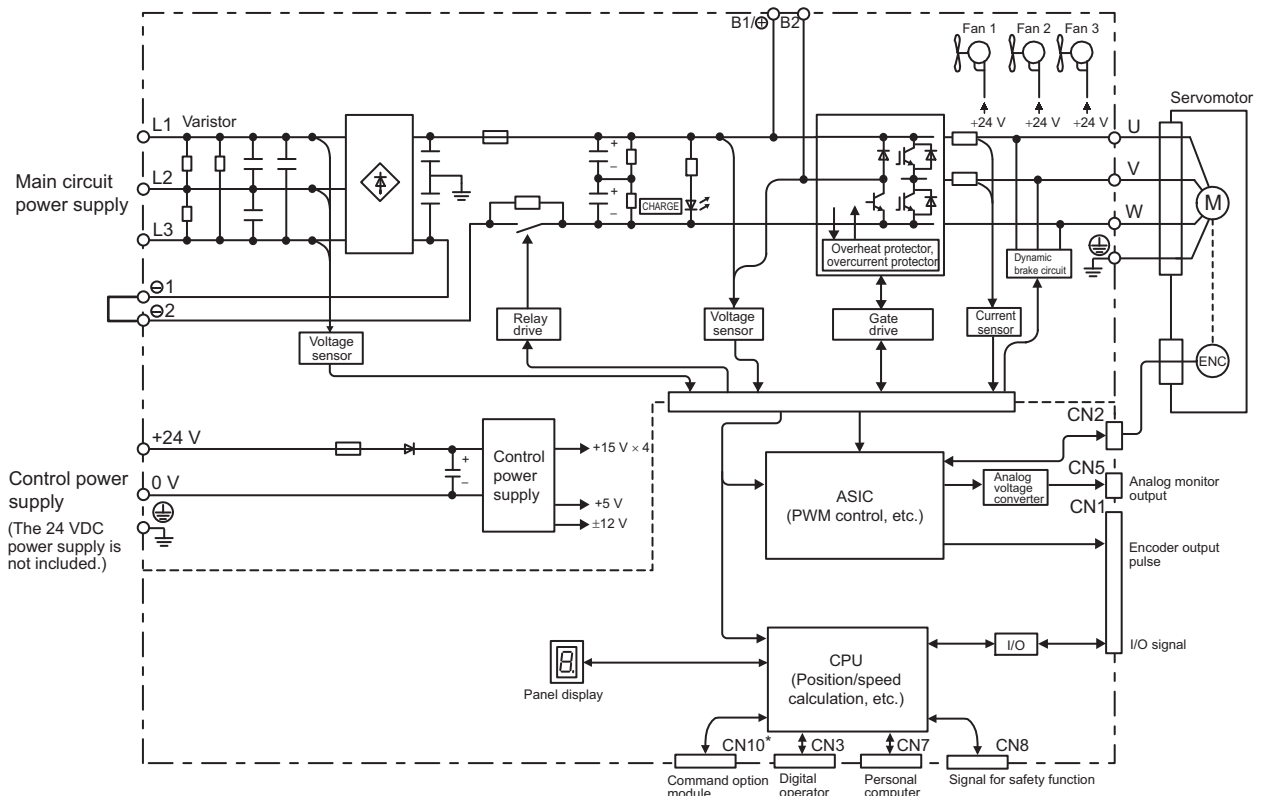

\* This external input signal is used by the option module.  
For details, refer to the manual of the connected option module.

## 1.6 Examples of Servo System Configurations

This section describes examples of basic servo system configuration.

### 1.6.1 Connecting to SGDV-□□□FE5A SERVOPACK

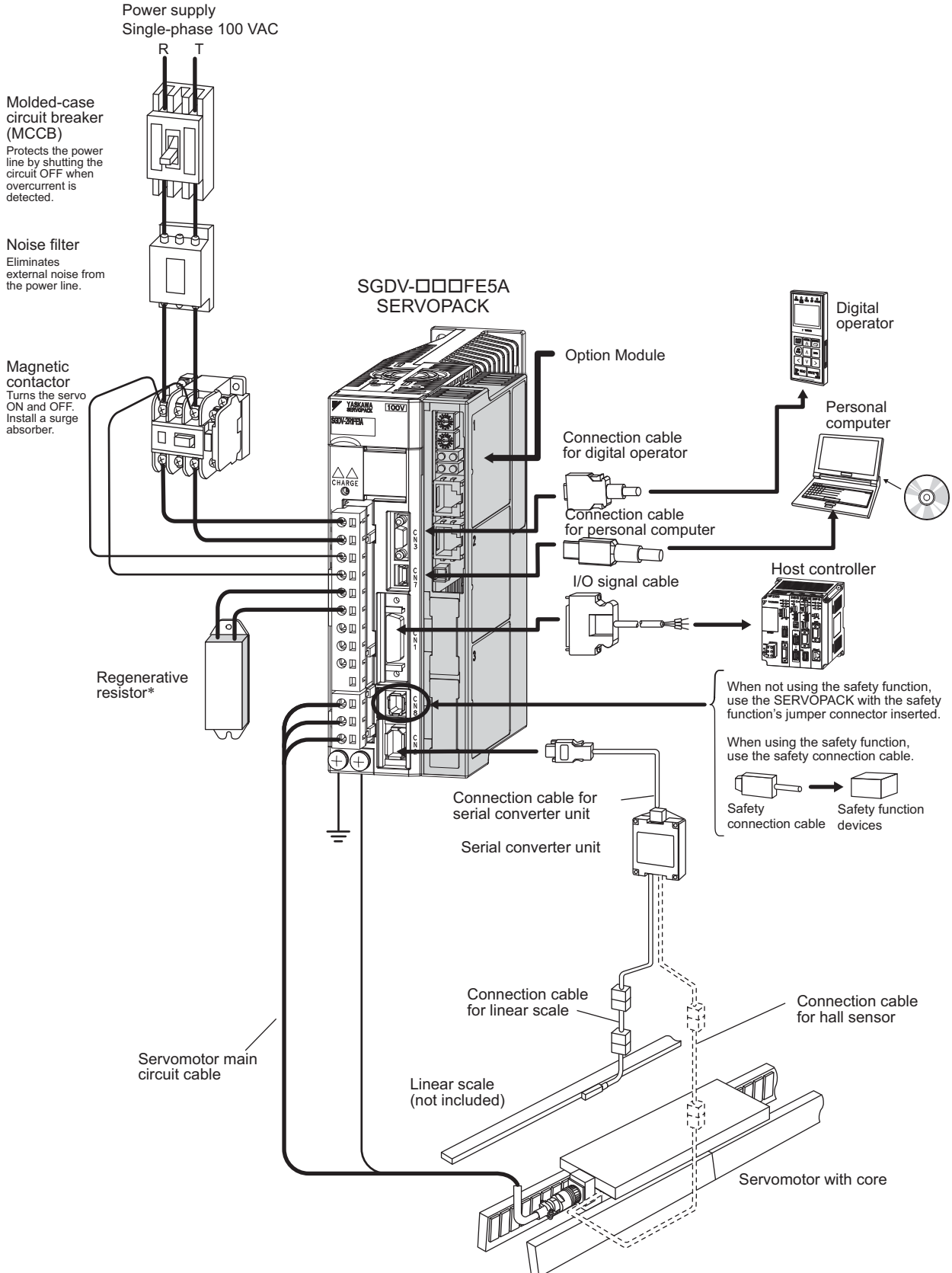

\* Before connecting an external regenerative resistor to the SERVOPACK, refer to 3.7 *Connecting Regenerative Resistors*.

## 1.6.2 Connecting to SGDV-□□□AE5A SERVOPACK

### (1) Using a Three-phase, 200-V Power Supply

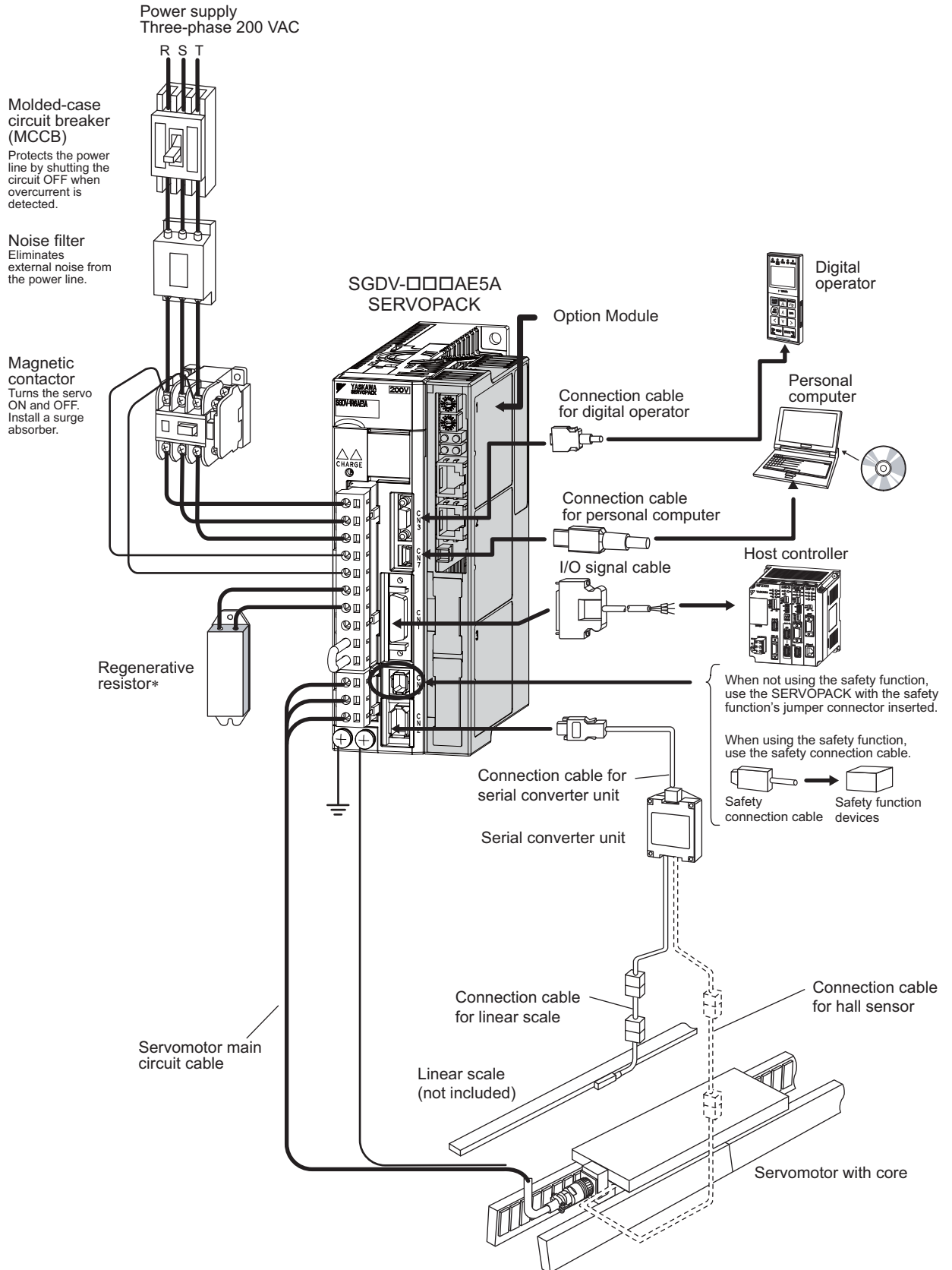

\* Before connecting an external regenerative resistor to the SERVOPACK, refer to 3.7 *Connecting Regenerative Resistors*.

## (2) Using a Single-phase, 200-V Power Supply

The  $\Sigma$ -V Series 200 V SERVOPACK generally specifies a three-phase power input but some models can be used with a single-phase 200 V power supply. Refer to 3.1.3 *Using the SERVOPACK with Single-phase, 200 V Power Input* for details.

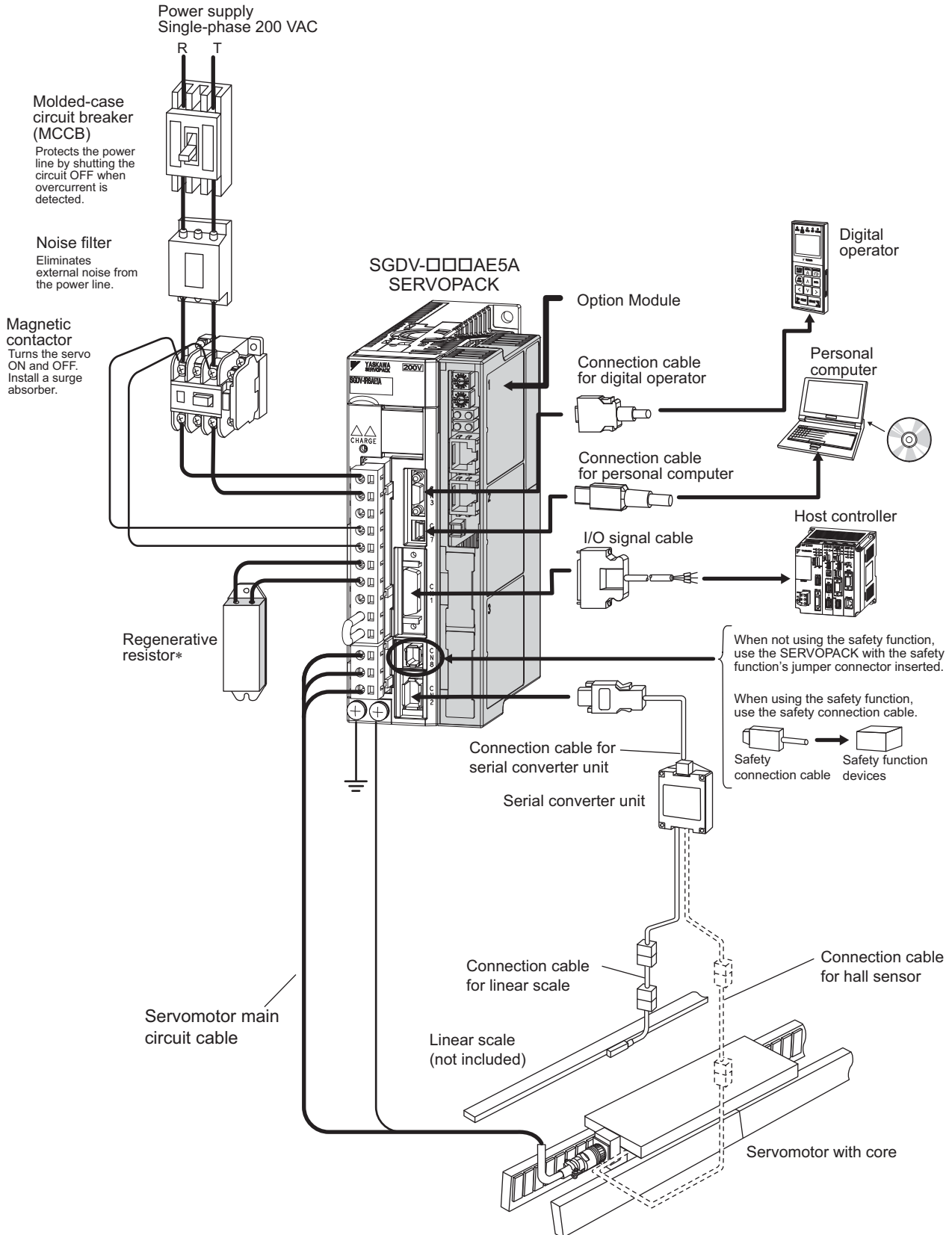

\* Before connecting an external regenerative resistor to the SERVOPACK, refer to 3.7 *Connecting Regenerative Resistors*.

### 1.6.3 Connecting to SGD□□□DE5A SERVOPACK

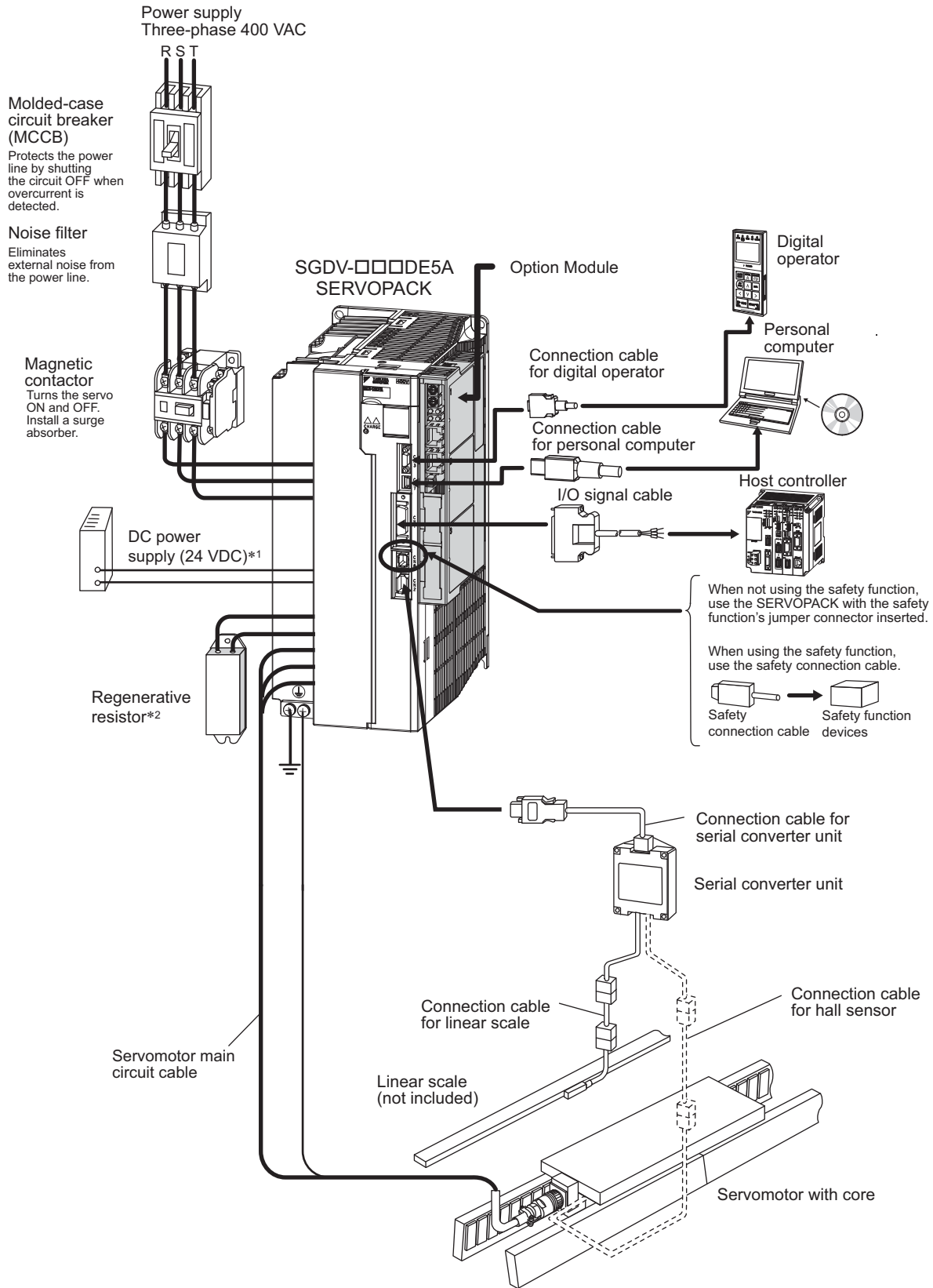

\*1. Use a 24-VDC power supply with double insulation or reinforced insulation. (The power supply is not included.)  
 \*2. Before connecting an external regenerative resistor to the SERVOPACK, refer to 3.7 *Connecting Regenerative Resistors*.

# 1.7 SERVOPACK Model Designation

This section shows SERVOPACK model designation.

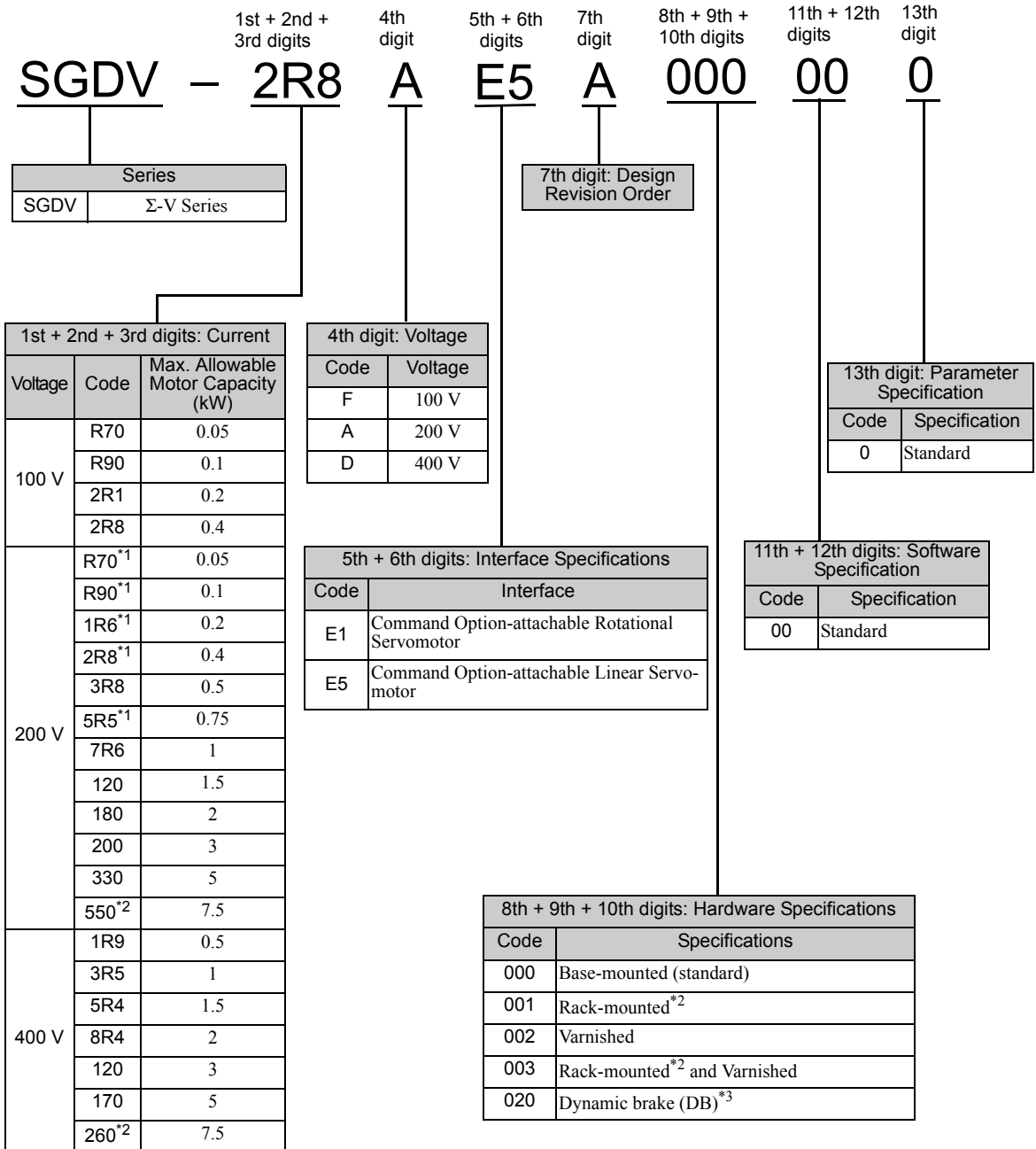

\*1. These amplifiers can be powered with single or three-phase.  
 \*2. SGDV-550A and -260D are duct-ventilated types.  
 \*3. A resistor for the dynamic brake is not included. An external resistor for the dynamic brake can only be used with 400-V SERVOPACKs.  
 Note: If the option codes digits 8 to 13 are all zeros, they are omitted.

## 1.8 Servo Drive Maintenance and Inspection

This section describes the inspection and maintenance of a servo drive.

### 1.8.1 SERVOPACK Inspection

For inspection and maintenance of the SERVOPACK, follow the inspection procedures in the following table at least once every year. Other routine inspections are not required.

Item	Frequency	Procedure	Comments
Exterior	At least once a year	Check for dust, dirt, and oil on the surfaces.	Clean with a cloth or compressed air.
Loose Screws		Check for loose terminal block and connector screws.	Tighten any loose screws.

### 1.8.2 SERVOPACK's Parts Replacement Schedule

The following electric or electronic parts are subject to mechanical wear or deterioration over time. To avoid failure, replace these parts at the frequency indicated.

Refer to the standard replacement period in the following table and contact your Yaskawa representative. After an examination of the part in question, we will determine whether the parts should be replaced or not.

 <b>IMPORTANT</b>	<p>The parameters of any SERVOPACKs overhauled by Yaskawa are reset to the factory settings before shipping. Be sure to confirm that the parameters are properly set before starting operation.</p>
--	---

Part	Standard Replacement Period
Cooling Fan	4 to 5 years
Smoothing Capacitor	7 to 8 years
Other Aluminum Electrolytic Capacitor	5 years
Relays	–
Fuses	10 years

Note: The standard replacement period is given for usage under the following operating conditions.

- Surrounding air temperature: Annual average of 30°C
- Load factor: 80% max.
- Operation rate: 20 hours/day max.

### 1.8.3 Servomotor Inspection

The AC servomotor is brushless and simple daily inspection is sufficient. Use the inspection frequencies given in the following table as a guide. Determine the most appropriate inspection frequency from the actual usage conditions and the environment.

Inspected Item	Inspection Frequency or Interval	Inspection or Maintenance Procedure	Remark
Vibration and Noise Check	Daily	Inspect by touching and listening to the servomotor.	There should be no more vibration or noise than normal.
Appearance Inspection	Depends on amount of dirt.	Clean with a cloth or compressed air.	–
Insulation Resistance Measurement	At least once a year	Disconnect the servomotor from the SERVOPACK and measure the insulation resistance with a 500 V insulation resistance meter.* The servomotor is normal if the resistance is higher than 10 MΩ	<ul style="list-style-type: none"> <li>• If the resistance is 10 MΩ or lower, contact your Yaskawa representative.</li> <li>• Do not measure the insulation resistance of the encoder or perform a withstand test on it.</li> </ul>
Oil Seal Replacement	At least once every 5,000 hours	Contact your Yaskawa representative.	Only necessary if the servomotor has an oil seal.
Overhaul	At least once every 5 years or 20,000 hours	Contact your Yaskawa representative.	–

\* Measure the insulation resistance between the U, V, or W phase on the servomotor's power line and the frame ground.

---

## Panel Display and Operation of Digital Operator





2.1 Panel Display .....	2-2
2.1.1 Status Display .....	2-2
2.1.2 Alarm and Warning Display .....	2-2
2.1.3 Hard Wire Base Block Display .....	2-2
2.1.4 Overtravel Display .....	2-2
2.2 Operation of Digital Operator .....	2-3
2.3 Utility Functions (Fn□□□) .....	2-3
2.4 Parameters (Pn□□□) .....	2-4
2.4.1 Parameter Classification .....	2-4
2.4.2 Notation for Parameters .....	2-4
2.4.3 Setting Parameters .....	2-5
2.5 Monitor Displays (Un□□□) .....	2-7

## 2.1 Panel Display

You can use the panel display on the SERVOPACK to check the status of the servo drive. Also, if an alarm or warning occurs, its alarm or warning number is displayed.

### 2.1.1 Status Display

The display shows the following status.

Display	Meaning
	Movement Detection (/TGON) Lights if motor speed exceeds the value set in Pn581. (Factory setting: 20 mm/s)
	Baseblock Lights for baseblock (Servomotor power OFF).
	Reference Input Lights when a reference is being input.
	Command Option Module Communications Status Display Lights when communications with the command option module are normal.

### 2.1.2 Alarm and Warning Display

If an alarm or warning occurs, the display will change in the following order.

Example: Alarm A.E60

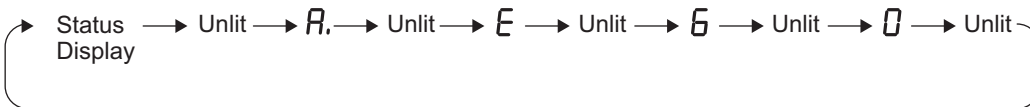

### 2.1.3 Hard Wire Base Block Display

If a hard wire base block (HWBB) occurs, the display will change in the following order.

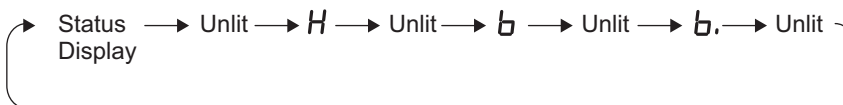

### 2.1.4 Overtravel Display

If overtraveling occurs, the display will change in the following order.

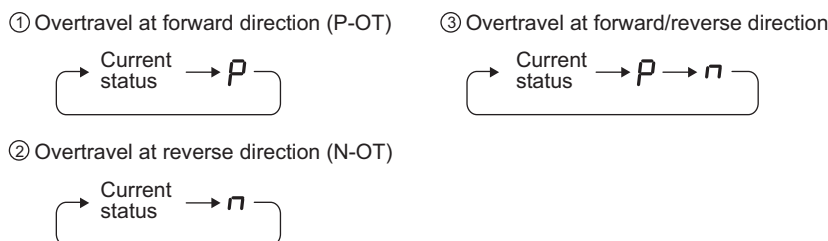

## 2.2 Operation of Digital Operator

Operation examples of utility functions (Fn□□□), parameters (Pn□□□) and monitor displays (Un□□□) when using a digital operator are described in this chapter.

Operations can be also performed with SigmaWin+.



























For more information on the usage of the digital operator, refer to *Σ-V Series USER'S MANUAL Operation of Digital Operator* (No.: SIEP S800000 55).

## 2.3 Utility Functions (Fn□□□)

The utility functions are related to the setup and adjustment of the SERVOPACK.

The digital operator shows numbers beginning with Fn.

The following table outlines the procedures necessary for an origin search (Fn003).

Step	Display after Operation	Keys	Operation									
1	<pre> BB          -FUNCTION- Fn002:JOG Fn003:Z-Search Fn004:Program JOG Fn005:Prm Init           </pre>	  	<p>Press the  Key to view the main menu for the utility function.</p> <p>Use the  or  Key to move through the list and select Fn003.</p>									
2	<pre> BB          -Z-Search- Un000= 00000 Un002= 00000 Un003= 0000000774 Un00D= 0000000000           </pre>		<p>Press the  Key. The display changes to the Fn003 execution display.</p>									
3	<pre> RUN          -Z-Search- Un000= 00000 Un002= 00000 Un003= 0000000774 Un00D= 0000000000           </pre>		<p>Press the  Key.</p> <p>The status display changes from "BB" to "RUN", and the servomotor power turns ON.</p> <p>Note: If the servomotor is already at the zero position, "-Complete-" is displayed.</p>									
4	<pre> RUN          -Complete- Un000= 00000 Un002= 00000 Un003= 0000000000 Un00D= 0000001D58           </pre>	 	<p>Pressing the  Key will run the servomotor in the forward direction. Pressing the  Key will run the servomotor in the reverse direction. The movement direction of the servomotor changes according to the setting of Pn000.0 as shown in the following table.</p> <table border="1"> <thead> <tr> <th>Parameter</th> <th> key</th> <th> key</th> </tr> </thead> <tbody> <tr> <td>Pn000</td> <td>n.□□□0 Linear scale counting up</td> <td>Linear scale counting down</td> </tr> <tr> <td></td> <td>n.□□□1 Linear scale counting down</td> <td>Linear scale counting up</td> </tr> </tbody> </table> <p>Note: Forward movement is the linear scale counting up direction. For details, refer to 4.2.2 <i>Servomotor Movement Direction</i>.</p> <p>Press the  or  Key until the servomotor stops. If the origin search completed normally, "-Complete-" is displayed on the right top on the screen.</p>	Parameter	 key	 key	Pn000	n.□□□0 Linear scale counting up	Linear scale counting down		n.□□□1 Linear scale counting down	Linear scale counting up
Parameter	 key	 key										
Pn000	n.□□□0 Linear scale counting up	Linear scale counting down										
	n.□□□1 Linear scale counting down	Linear scale counting up										
5	<pre> BB          -Z-Search- Un000= 00000 Un002= 00000 Un003= 0000000000 Un00D= 0000001D58           </pre>		<p>When the origin search is completed, press the  Key.</p> <p>The status display changes from "RUN" to "BB", and the servomotor turns OFF. The display "-Complete-" changes to "-Z-Search-".</p>									
6	<pre> BB          -FUNCTION- Fn002:JOG Fn003:Z-Search Fn004:Program JOG Fn005:Prm Init           </pre>		<p>Press the  Key.</p> <p>The display returns to the main menu of the utility function.</p>									
7	To enable the change in the setting, turn the power OFF and ON again.											

## 2.4 Parameters (Pn□□□)

This section describes the classifications, methods of notation, and settings for parameters given in this manual.

### 2.4.1 Parameter Classification

Parameters of the Σ-V Series SERVOPACK are classified into two types of parameters. One type of parameters is required for setting up the basic conditions for operation and the other type is required for tuning parameters that are required to adjust servomotor characteristics.

Classification	Meaning	Display Method	Setting Method
Setup Parameters	Parameters required for setup.	Always displayed (Factory setting: Pn00B.0 = 0)	Set each parameter individually.
Tuning Parameters	Parameters for tuning control gain and other parameters.	Set Pn00B.0 to 1.	There is no need to set each parameter individually.

There are two types of notation used for parameters, one for parameter that requires a value setting (parameter for numeric settings) and one for parameter that requires the selection of a function (parameter for selecting functions).

The notation and settings for both types of parameters are described next.

### 2.4.2 Notation for Parameters

#### (1) Parameters for Numeric Settings

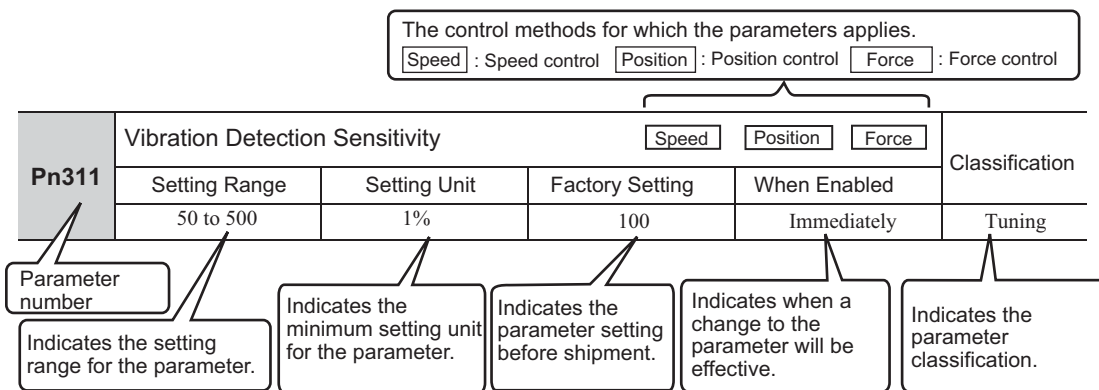

#### (2) Parameters for Selecting Functions

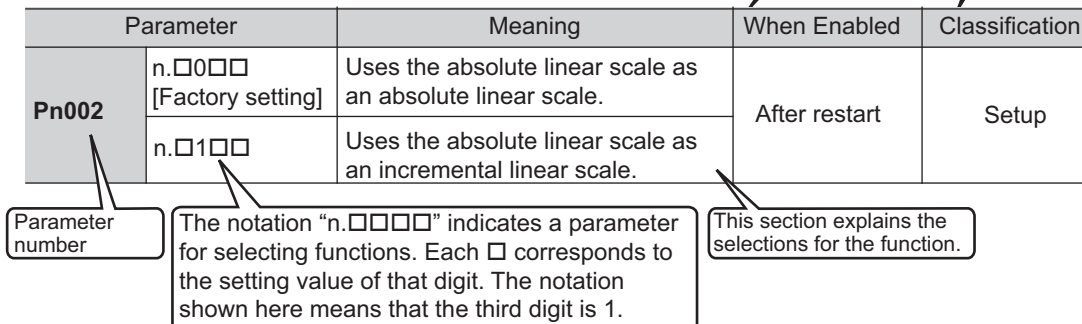

• Notation Example

Digital Operator Display (Display Example for Pn002)

n . 0 0 0 0	Digit Notation		Setting Notation	
	Notation	Meaning	Notation	Meaning
→ 1st digit	Pn002.0	Indicates the value for the 1st digit of parameter Pn002.	Pn002.0 = x or n.□□□x	Indicates that the value for the 1st digit of parameter Pn002 is x.
→ 2nd digit	Pn002.1	Indicates the value for the 2nd digit of parameter Pn002.	Pn002.1 = x or n.□□x□	Indicates that the value for the 2nd digit of parameter Pn002 is x.
→ 3rd digit	Pn002.2	Indicates the value for the 3rd digit of parameter Pn002.	Pn002.2 = x or n.□x□□	Indicates that the value for the 3rd digit of parameter Pn002 is x.
→ 4th digit	Pn002.3	Indicates the value for the 4th digit of parameter Pn002.	Pn002.3 = x or n.x□□□	Indicates that the value for the 4th digit of parameter Pn002 is x.



### 2.4.3 Setting Parameters

#### (1) How to Make Numeric Settings Using Parameters

The following example shows how to change the setting of parameter Pn383 (JOG speed) to 1000 mm/s.























Step	Display after Operation	Keys	Operation
1	BB -PRM/MON- Un000= 00000 Un002= 00000 Un008= 00000 Un00D=00000000		Press the  Key to select the main menu of parameters and monitor displays.
2	BB -PRM/MON- Un000= 00000 Un002= 00000 Un008= 00000 Un00D=00000000		Press the  or  Key to move the cursor to "Un."
3	BB -PRM/MON- Pn000=n.0000 Un002= 00000 Un008= 00000 Un00D=00000000		Press the  or  Key to change "Un" to "Pn."
4	BB -PRM/MON- Pn000=n.0000 Un002= 00000 Un008= 00000 pulse Un00D=00000000		Press the  Key to move the cursor to the column on the right of "Pn."
5	BB -PRM/MON- Pn383=00500 Un002= 00000 Un008= 00000 Un00D=00000000	 	Press the arrow keys to display "Pn383". To move the cursor to different columns: ,  Key To change the settings: ,  Key
6	BB -PRM/MON- Pn383=0050 <u>0</u> Un002= 00000 Un008= 00000 Un00D=00000000		Press the  Key to move the cursor to the one's place of Pn383.
7	BB -PRM/MON- Pn383=00 <u>5</u> 00 Un002= 00000 Un008= 00000 Un00D=00000000		Press the  Key twice to move the cursor to the hundred's place of Pn383.
8	BB -PRM/MON- Pn383=01 <u>0</u> 00 Un002= 00000 Un008= 00000 Un00D=00000000		Press the  Key five times to change the setting to "1000."

(cont'd)

Step	Display after Operation	Keys	Operation
9	<pre> BB          -PRM/MON- Pn383=01000 Un002= 00000 Un008= 00000 Un00D=00000000           </pre>		Press the  Key to write the settings.

## (2) How to Select Functions Using Parameters

The following example shows how to set the function section for insufficient voltage of the application function select switch 8 (Pn008) to 1 "detects warning and limits force by host controller."

Step	Display after Operation	Keys	Operation
1	<pre> BB          -PRM/MON- Un000= 00000 Un002= 00000 Un008= 00000 Un00D=00000000           </pre>		Press the  Key to select the main menu of parameters and monitor displays.
2	<pre> BB          -PRM/MON- Un000= 00000 Un002= 00000 Un008= 00000 Un00D=00000000           </pre>	 	Press the  or  Key to move the cursor to "Un."
3	<pre> BB          -PRM/MON- Pn000=n,0000 Un002= 00000 Un008= 00000 Un00D=00000000           </pre>	 	Press the  or  Key to change "Un" to "Pn."
4	<pre> BB          -PRM/MON- Pn000=n,0000 Un002= 00000 Un008= 00000 Un00D=00000000           </pre>		Press the  Key three times to move the cursor to the column on the right of "Pn."
5	<pre> BB          -PRM/MON- Pn008=n,4000 Un002= 00000 Un008= 00000 Un00D=00000000           </pre>		Press the  Key to display "Pn008."
6	<pre> BB          -PRM/MON- Pn008=n,4000 Un002= 00000 Un008= 00000 Un00D=00000000           </pre>		Press the  Key to move the cursor to "Pn008.0."
7	<pre> BB          -PRM/MON- Pn008=n,4000 Un002= 00000 Un008= 00000 Un00D=00000000           </pre>		Press the  Key once to move the cursor to "Pn008.1."
8	<pre> BB          -PRM/MON- Pn008=n,4010 Un002= 00000 Un008= 00000 Un00D=00000000           </pre>		Press the  Key to change the setting of "Pn008.1" to "1."
9	<pre> BB          -PRM/MON- Pn008=n,4010 Un002= 00000 Un008= 00000 Un00D=00000000           </pre>		Press the  Key to write the settings.

## 2.5 Monitor Displays (Un□□□)

The monitor displays can be used for monitoring the reference values, I/O signal status, and SERVOPACK internal status.

For details, refer to 7.2 *Viewing Monitor Displays*.

The digital operator shows numbers beginning with Un.

The following four settings are the factory settings.

BB		—PRM/MON—
Un000	=	00000
Un002	=	00000
Un008	=	00000
Un00D	=	00000000

← Shows the setting of Un000 (motor moving speed) as 0 mm/s.

## Wiring and Connection

3.1	Main Circuit Wiring	3-2
3.1.1	Main Circuit Terminals	3-2
3.1.2	Using a Standard Power Supply (Single-phase 100 V, Three-phase 200 V, or Three-phase 400 V)	3-3
3.1.3	Using the SERVOPACK with Single-phase, 200 V Power Input	3-10
3.1.4	Using the SERVOPACK with a DC Power Input	3-13
3.1.5	Using More Than One SERVOPACK	3-15
3.1.6	General Precautions for Wiring	3-16
3.2	I/O Signal Connections	3-17
3.2.1	I/O Signal (CN1) Names and Functions	3-17
3.2.2	Safety Function Signal (CN8) Names and Functions	3-18
3.2.3	Example of I/O Signal Connections	3-19
3.3	I/O Signal Allocations	3-20
3.3.1	Input Signal Allocations	3-20
3.3.2	Output Signal Allocations	3-22
3.4	Examples of Connection to Host Controller	3-23
3.4.1	Sequence Input Circuit	3-23
3.4.2	Sequence Output Circuit	3-24
3.5	Wiring Communications Using Command Option Modules	3-26
3.6	Linear Scale Connection	3-27
3.6.1	Linear Scale Signal (CN2) Names and Functions	3-27
3.6.2	Serial Converter Unit	3-27
3.6.3	Linear Scale Connection Examples	3-30
3.7	Connecting Regenerative Resistors	3-34
3.7.1	Connecting Regenerative Resistors	3-34
3.7.2	Setting Regenerative Resistor Capacity	3-36
3.8	Noise Control and Measures for Harmonic Suppression	3-37
3.8.1	Wiring for Noise Control	3-37
3.8.2	Precautions on Connecting Noise Filter	3-39
3.8.3	Connecting a Reactor for Harmonic Suppression	3-40

## 3.1 Main Circuit Wiring

The names and specifications of the main circuit terminals are given below.

Also this section describes the general precautions for wiring and precautions under special environments.

### 3.1.1 Main Circuit Terminals

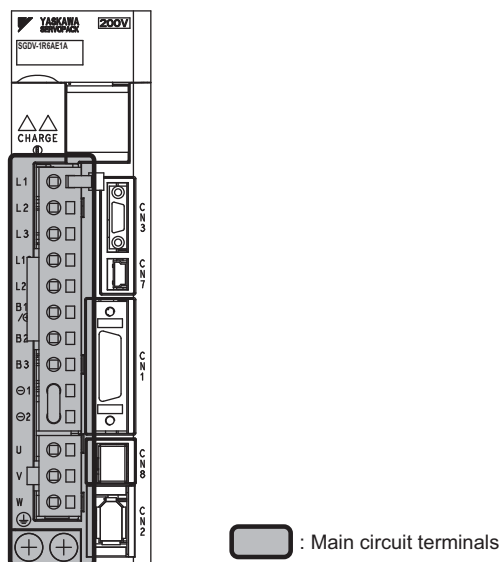

Terminal Symbols	Name	Model SGDV-□□□□	Specification
L1, L2	Main circuit power input terminals	□□□F	Single-phase 100 to 115 V, +10 to -15%, 50/60 Hz
L1, L2, L3		□□□A	Three-phase 200 to 230 V, +10 to -15%, 50/60 Hz
		□□□D	Three-phase 380 to 480 V, +10 to -15%, 50/60 Hz
L1C, L2C	Control power input terminals	□□□F	Single-phase 100 to 115 V, +10 to -15%, 50/60 Hz
24V, 0V		□□□A	Single-phase 200 to 230 V, +10 to -15%, 50/60 Hz
		□□□D	24 VDC, ±15%
B1/⊕, B2*1	External regenerative resistor connection terminals	R70F, R90F, 2R1F, 2R8F, R70A, R90A, 1R6A, 2R8A	If the regenerative capacity is insufficient, connect an external regenerative resistor between B1/⊕ and B2. Note: The external regenerative resistor is not included.
		3R8A, 5R5A, 7R6A, 120A, 180A, 200A, 330A, 1R9D, 3R5D, 5R4D, 8R4D, 120D, 170D	If the internal regenerative resistor is insufficient, remove the lead or shorting bar between B2 and B3 and connect an external regenerative resistor between B1/⊕ and B2. Note: The external regenerative resistor is not included.
		550A, 260D	Connect a regenerative resistor unit between B1/⊕ and B2. Note: The regenerative resistor unit is not included.
⊕1, ⊕2*2	DC reactor connection terminal for power supply harmonic suppression	□□□A □□□D	If a countermeasure against power supply harmonic waves is needed, connect a DC reactor between ⊕1 and ⊕2.
B1/⊕	Main circuit positive terminal	□□□A □□□D	Use when DC power supply input is used.
⊕2 or ⊕	Main circuit negative terminal	□□□A □□□D	
U, V, W	Servomotor connection terminals		Use for connecting to the servomotor.
⊕	Ground terminals (× 2)		Use for connecting the power supply ground terminal and servomotor ground terminal.

- \*1. Do not short-circuit between B1/⊕ and B2. It may damage the SERVOPACK.
- \*2. The DC reactor connection terminals are short-circuited when the SERVOPACK is shipped from the factory: ⊖1 and ⊖2.

### 3.1.2 Using a Standard Power Supply (Single-phase 100 V, Three-phase 200 V, or Three-phase 400 V)

#### (1) Wire Types

Use the following type of wire for main circuit.

Cable Type		Allowable Conductor Temperature °C
Symbol	Name	
IV	600 V grade polyvinyl chloride insulated wire	60
HIV	600 V grade heat-resistant polyvinyl chloride insulated wire	75

The following table shows the wire sizes and allowable currents for three wires. Use wires with specifications equal to or less than those shown in the table.

- 600 V grade heat-resistant polyvinyl chloride insulated wire (HIV)

AWG Size	Nominal Cross Section Area (mm <sup>2</sup> )	Configuration (Number of Wires/mm)	Conductive Resistance (Ω/km)	Allowable Current at Surrounding Air Temperature (A)		
				30°C	40°C	50°C
20	0.5	19/0.18	39.5	6.6	5.6	4.5
19	0.75	30/0.18	26.0	8.8	7.0	5.5
18	0.9	37/0.18	24.4	9.0	7.7	6.0
16	1.25	50/0.18	15.6	12.0	11.0	8.5
14	2.0	7/0.6	9.53	23	20	16
12	3.5	7/0.8	5.41	33	29	24
10	5.5	7/1.0	3.47	43	38	31
8	8.0	7/1.2	2.41	55	49	40
6	14.0	7/1.6	1.35	79	70	57
4	22.0	7/2.0	0.85	91	81	66

Note: The values in the table are for reference only.

#### (2) Main Circuit Wires

This section describes the main circuit wires for SERVOPACKs.



#### IMPORTANT

- The specified wire sizes are for use when the three lead cables are bundled and when the rated electric current is applied with a surrounding air temperature of 40°C.
- Use a wire with a minimum withstand voltage of 600 V for the main circuit.
- If cables are bundled in PVC or metal ducts, take into account the reduction of the allowable current.
- Use a heat-resistant wire under high surrounding air or panel temperatures, where polyvinyl chloride insulated wires will rapidly deteriorate.

■ Single-phase, 100 V

Terminal Symbols	Name	SGDV-□□□F			
		R70	R90	2R1	2R8
L1, L2	Main circuit power input terminals	HIV1.25		HIV2.0	
L1C, L2C	Control power input terminals	HIV1.25			
U, V, W	Servomotor connection terminals	HIV1.25			
B1/⊕, B2	External regenerative resistor connection terminals	HIV1.25			
⊕	Ground terminal	HIV2.0 or larger			

■ Three-phase, 200 V

Terminal Symbols	Name	SGDV-□□□A (Unit: mm <sup>2</sup> )										
		R70	R90	1R6	2R8	3R8	5R5	7R6	120	180	200	330
L1, L2, L3	Main circuit power input terminals	HIV1.25			HIV2.0				HIV3.5		HIV5.5	HIV14.0
L1C, L2C	Control power input terminals	HIV1.25										
U, V, W	Servomotor connection terminals	HIV1.25			HIV2.0				HIV3.5	HIV5.5	HIV8.0	HIV14.0
B1/⊕, B2	External regenerative resistor connection terminals	HIV1.25						HIV2.0	HIV3.5	HIV5.5	HIV8.0	
⊕	Ground terminal	HIV2.0 or larger										

■ Three-phase, 400 V

Terminal Symbols	Name	SGDV-□□□D (Unit: mm <sup>2</sup> )						
		1R9	3R5	5R4	8R4	120	170	260
L1, L2, L3	Main circuit power input terminals	HIV1.25			HIV2.0		HIV3.5	HIV5.5
24V, 0V	Control power input terminals	HIV1.25						
U, V, W	Servomotor connection terminals	HIV1.25			HIV2.0		HIV3.5	HIV5.5
B1/⊕, B2	External regenerative resistor connection terminals	HIV1.25					HIV2.0	HIV3.5
⊕	Ground terminal	HIV2.0 or larger						

### (3) Typical Main Circuit Wiring Examples

Note the following points when designing the power ON sequence.

- Design the power ON sequence so that main power is turned OFF when a servo alarm signal (ALM) is output.
- The ALM signal is output for a maximum of five seconds when the control power is turned ON. Take this into consideration when designing the power ON sequence. Design the sequence so the ALM signal is activated and the alarm detection relay (1Ry) is turned OFF to stop the main circuit's power supply to the SERVOPACK.

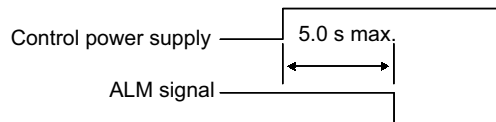

- Select the power supply specifications for the parts in accordance with the input power supply.



**IMPORTANT**

- When turning ON the control power supply and the main circuit power supply, turn them ON at the same time or turn the main circuit power supply after the control power supply. When turning OFF the power supplies, first turn the power for the main circuit OFF and then turn OFF the control power supply.

The typical main circuit wiring examples are shown below.

 **WARNING**

- Do not touch the power supply terminals after turning OFF the power. High voltage may still remain in the SERVOPACK, resulting in electric shock. When the voltage is discharged, the charge indicator will turn OFF. Make sure the charge indicator is OFF before starting wiring or inspections.

■ Single-phase 100 V, SGD□-□□□F (SGDV-R70F, -R90F, -2R1F, -2R8F)

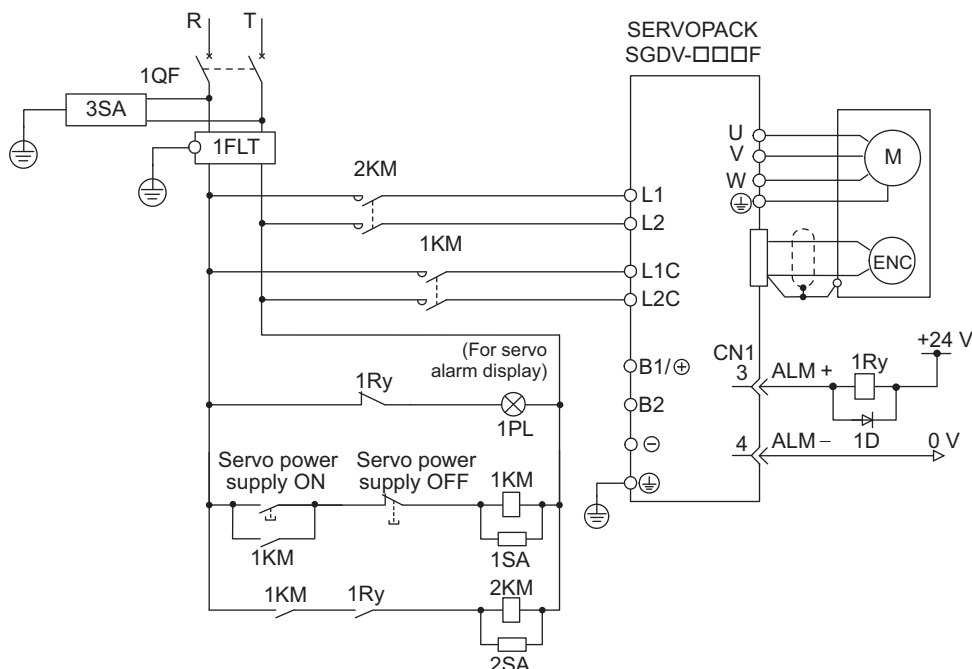

- |   |                     |
|---|---------------------|
| 1QF: Molded-case circuit breaker                        | 1PL: Indicator lamp |
| 1FLT: Noise filter                                      | 1SA: Surge absorber |
| 1KM: Magnetic contactor (for control power supply)      | 2SA: Surge absorber |
| 2KM: Magnetic contactor (for main circuit power supply) | 3SA: Surge absorber |
| 1Ry: Relay  | 1D: Flywheel diode  |

■ Three-phase 200 V, SGDV-□□□A

- SGDV-R70A, -R90A, -1R6A, -2R8A, -3R8A, -5R5A, -7R6A, -120A, -180A, -200A, -330A

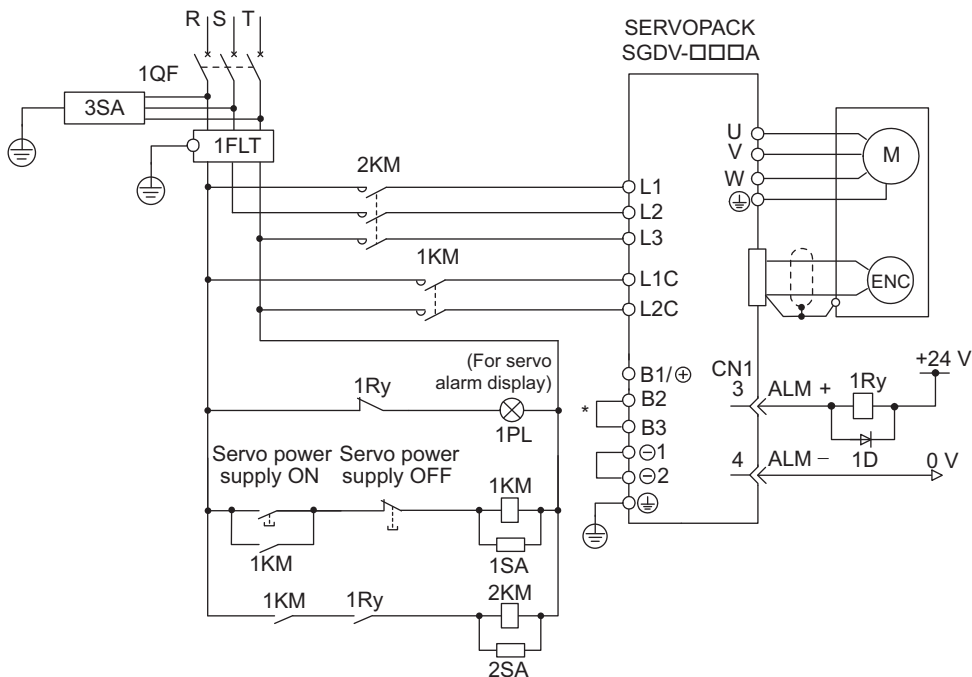

- 1QF: Molded-case circuit breaker
- 1FLT: Noise filter
- 1KM: Magnetic contactor (for control power supply)
- 2KM: Magnetic contactor (for main circuit power supply)
- 1Ry: Relay
- 1PL: Indicator lamp
- 1SA: Surge absorber
- 2SA: Surge absorber
- 3SA: Surge absorber
- 1D: Flywheel diode

\* For the SGDV-R70A, -R90A, -1R6A, -2R8A, terminals B2 and B3 are not short-circuited. Do not short-circuit these terminals.

- SGDV-550A

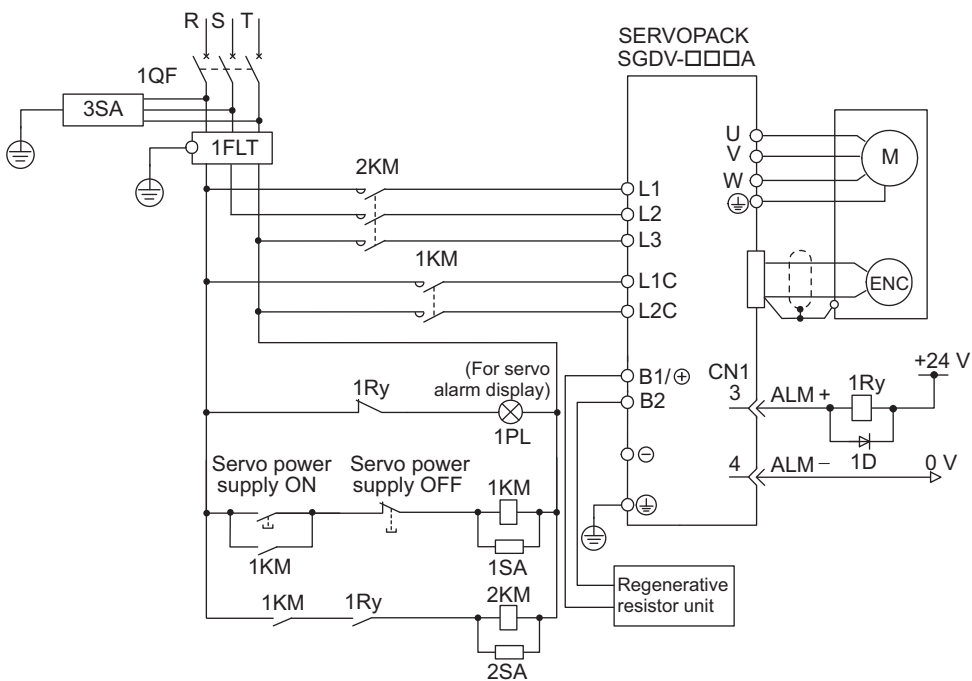

- 1QF: Molded-case circuit breaker
- 1FLT: Noise filter
- 1KM: Magnetic contactor (for control power supply)
- 2KM: Magnetic contactor (for main circuit power supply)
- 1Ry: Relay
- 1PL: Indicator lamp
- 1SA: Surge absorber
- 2SA: Surge absorber
- 3SA: Surge absorber
- 1D: Flywheel diode

■ Three-phase 400 V, SGDV-□□□□D

- SGDV-1R9D, -3R5D, -5R4D, -8R4D, -120D, -170D

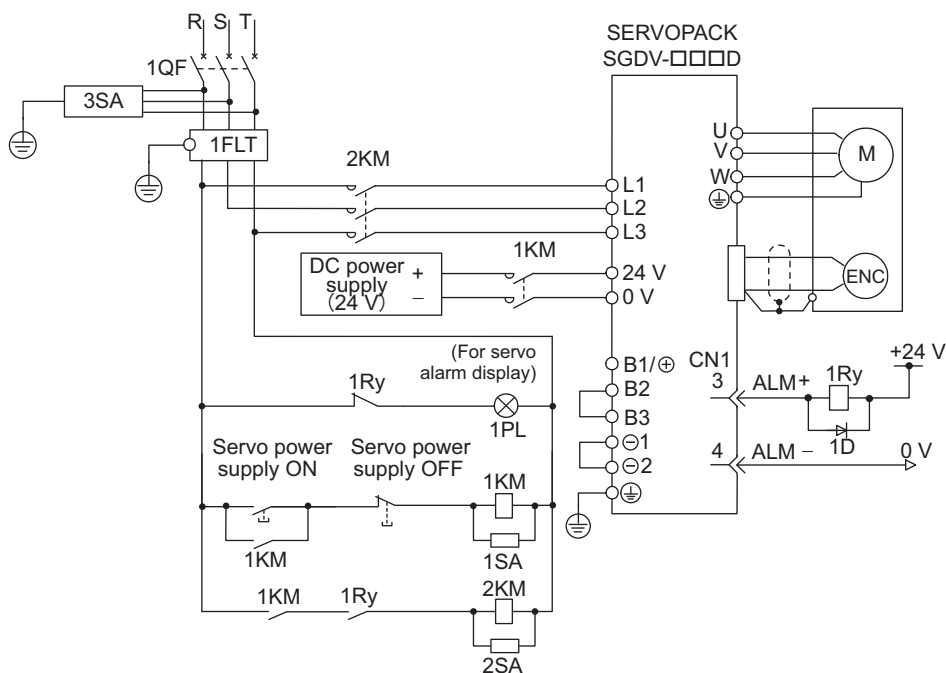

- |   |                     |
|---|---------------------|
| 1QF: Molded-case circuit breaker                        | 1PL: Indicator lamp |
| 1FLT: Noise filter                                      | 1SA: Surge absorber |
| 1KM: Magnetic contactor (for control power supply)      | 2SA: Surge absorber |
| 2KM: Magnetic contactor (for main circuit power supply) | 3SA: Surge absorber |
| 1Ry: Relay  | 1D: Flywheel diode  |

- SGDV-260D

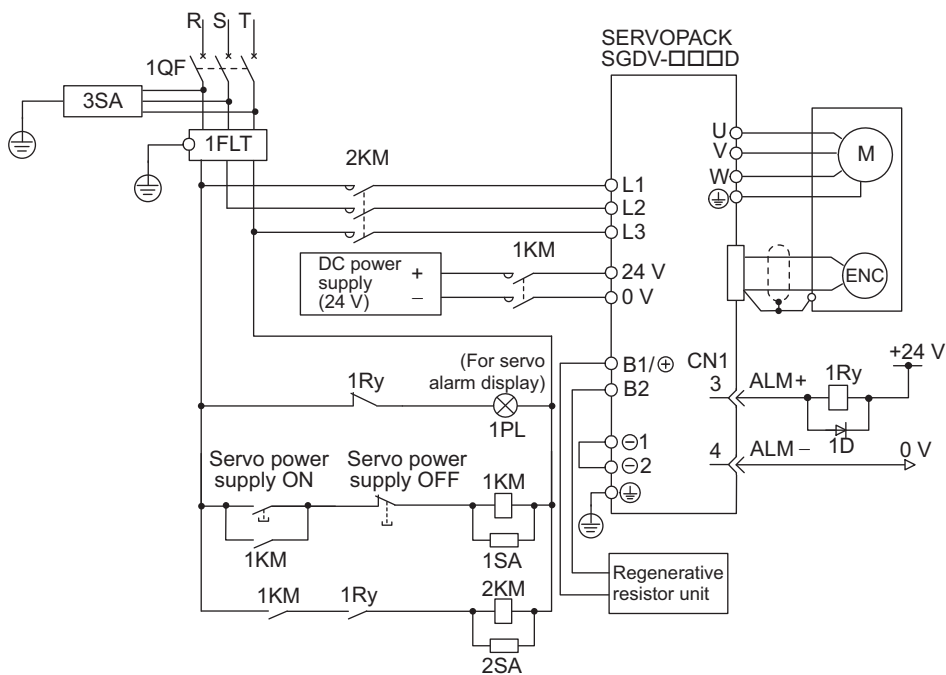

- |   |                     |
|---|---------------------|
| 1QF: Molded-case circuit breaker                        | 1PL: Indicator lamp |
| 1FLT: Noise filter                                      | 1SA: Surge absorber |
| 1KM: Magnetic contactor (for control power supply)      | 2SA: Surge absorber |
| 2KM: Magnetic contactor (for main circuit power supply) | 3SA: Surge absorber |
| 1Ry: Relay  | 1D: Flywheel diode  |

## (4) Power Supply Capacities and Power Losses

The following table shows the SERVOPACK's power supply capacities and power losses.

Main Circuit Power Supply	Maximum Applicable Servomotor Capacity [kW]	SERVOPACK Model SGD V-	Power Supply Capacity per SERVOPACK [kVA]	Output Current [Arms]	Main Circuit Power Loss [W]	Regenerative Resistor Power Loss [W]	Control Circuit Power Loss [W]	Total Power Loss [W]
Single-phase, 100 V	0.05	R70F	0.2	0.66	5.4	-	17	22.4
	0.1	R90F	0.3	0.91	7.8			24.8
	0.2	2R1F	0.7	2.1	14.4			31.4
	0.4	2R8F	1.4	2.8	25.6			42.6
Three-phase, 200 V	0.05	R70A	0.2	0.66	5.1	-	17	22.1
	0.1	R90A	0.3	0.91	7.3			24.3
	0.2	1R6A	0.6	1.6	13.5			30.5
	0.4	2R8A	1	2.8	24.0			41.0
	0.5	3R8A	1.4	3.8	20.1	8	45.1	
	0.75	5R5A	1.6	5.5	43.8		68.8	
	1.0	7R6A	2.3	7.6	53.6		78.6	
	1.5	120A	3.2	11.6	65.8	10	22	97.8
	2.0	180A	4	18.5	111.9	16		149.9
	3.0	200A	5.9	19.6	113.8			161.4
	5.0	330A	7.5	32.9	263.7	36		27
7.5	550A	14.6	54.7	357.8	(350) <sup>*1</sup>	33		390.8
Three-phase, 400 V	0.5	1R9D	1.1	1.9	24.6	14	21	59.6
	1.0	3R5D	2.3	3.5	46.1			81.1
	1.5	5R4D	3.5	5.4	71.3			106.3
	2.0	8R4D	4.5	8.4	77.9	28	25	130.9
	3.0	120D	7.1	11.9	108.7			161.7
	5.0	170D	11.7	16.5	161.1	36	24	221.1
	7.5	260D	14.4	25.7	218.6	(180) <sup>*2</sup>	27	245.6

\*1. The value in parentheses is for the JUSP-RA05-E regenerative resistor unit.

\*2. The value in parentheses is for the JUSP-RA18-E regenerative resistor unit.

- Note 1. SGD V-R70F, -R90F, -2R1F, -2R8F, -R70A, -R90A, -1R6A, and -2R8A SERVOPACKs do not have built-in regenerative resistors. Connect an external regenerative resistor if the regenerative energy exceeds the specified value.
- SGD V-550A and -260D SERVOPACKs do not have built-in regenerative resistors. Make sure that a regenerative resistor unit or an external regenerative resistor is connected. Refer to 3.7 *Connecting Regenerative Resistors* for details.
  - Regenerative resistor power losses are the allowable losses. Take the following actions if this value is exceeded.
    - Remove the lead or shorting bar between terminals B2 and B3 on the SERVOPACK main circuit for SGD V-3R8A, -5R5A, -7R6A, -120A, -180A, -200A, -330A, and 400-V SERVOPACKs.
    - Install an external regenerative resistor. Refer to 3.7 *Connecting Regenerative Resistors* for details.

## (5) How to Select Molded-case Circuit Breaker and Fuse Capacities

The following table shows the SERVOPACK's current capacities and inrush current. Use these values as a basis for selecting the molded-case circuit breaker and fuse.

Main Circuit Power Supply	Maximum Applicable Servomotor Capacity [kW]	SERVOPACK Model SGD V-	Power Supply Capacity per SERVOPACK [kVA]	Current Capacity		Inrush Current	
				Main Circuit [Arms]	Control Circuit [Arms]	Main Circuit [A0-p]	Control Circuit [A0-p]
Single-phase, 100 V	0.05	R70F	0.2	1.5	0.38	16.5	35
	0.1	R90F	0.3	2.5			
	0.2	2R1F	0.7	5			
	0.4	2R8F	1.4	10			
Three-phase, 200 V	0.05	R70A	0.2	1.0	0.2	33	70
	0.1	R90A	0.3	1.0			
	0.2	1R6A	0.6	2.0			
	0.4	2R8A	1	3.0			
	0.5	3R8A	1.4	3.0			
	0.75	5R5A	1.6	6.0			
	1.0	7R6A	2.3	6.0	0.25	33	33
	1.5	120A	3.2	7.3			
	2.0	180A	4	9.7			
	3.0	200A	5.9	15			
	5.0	330A	7.5	25			
7.5	550A	14.6	37	0.3	65.5		
Three-phase, 400 V	0.5	1R9D	1.1	1.4	1.2	17	-
	1.0	3R5D	2.3	2.9			
	1.5	5R4D	3.5	4.3			
	2.0	8R4D	4.5	5.8	1.4	34	
	3.0	120D	7.1	8.6			
	5.0	170D	11.7	14.5			
	7.5	260D	14.4	21.7			

- Note 1. To comply with the EU low voltage directive, connect a fuse to the input side as protection against accidents caused by short-circuits.  
 Select fuses or molded-case circuit breakers that are compliant with UL standards.  
 The table above also provides the net values of current capacity and inrush current. Select a fuse and a molded-case circuit breaker which meet the breaking characteristics shown below.
- Main circuit, control circuit: No breaking at three times the current values shown in the table for 5 s.
  - Inrush current: No breaking at the current values shown in the table for 20 ms.
2. The following restrictions apply to UL standard compliance conditions.

SERVOPACK Model SGD V-	Restrictions
180A, 200A	Available rated current for modeled-case circuit breaker: 40 A or less
330A	<ul style="list-style-type: none"> <li>• Available rated current for non-time delay fuse: 70 A or less</li> <li>• Available rated current for time delay fuse: 40 A or less</li> <li>• Do not use single wires.</li> </ul>
550A	<ul style="list-style-type: none"> <li>• Available rated current for molded-case circuit breaker: 60 A or less</li> <li>• Available rated current for non-time delay fuse or time delay fuse: 60 A or less</li> </ul>
260D	<ul style="list-style-type: none"> <li>• Available rated current for molded-case circuit breaker: 60 A or less.</li> <li>• Available rated current for non-time-delay fuse: 60 A or less.</li> <li>• Available rated current for time delay fuse: 35 A or less</li> </ul>

### 3.1.3 Using the SERVOPACK with Single-phase, 200 V Power Input

Some models of  $\Sigma$ -V series three-phase 200 V power input SERVOPACK can be used also with a single-phase 200 V power supply.

The following models support a single-phase 200-V power input.  
SGDV-R70A, -R90A, -1R6A, -2R8A, -5R5A

When using the SERVOPACK with single-phase, 200 V power input, set parameter Pn00B.2 to 1.

#### (1) Parameter Setting

##### ■ Single-phase Power Input Selection

Parameter		Meaning	When Enabled	Classification
Pn00B	n.□0□□ [Factory setting]	Enables use of three-phase power supply for three-phase SERVOPACK.	After restart	Setup
	n.□1□□	Enables use of single-phase power supply for three-phase SERVOPACK.		

#### WARNING

- If single-phase 200 V is input to a SERVOPACK with a single-phase power input without changing the setting of Pn00B.2 to 1 (single-phase power input), a main circuit cable open phase alarm (A.F10) will be detected.
- SERVOPACK models other than those for single-phase 200-V power input do not support single-phase power input. If a single-phase 200 V is input to the SERVOPACK that do not support single-phase power input, the main circuit cable open phase alarm (A.F10) will be detected.
- When using a single-phase 200 V power supply, the SGDV-R70A, -R90A, -1R6A, -2R8A, or -5R5A SERVOPACK may not be able to produce the same servomotor force-speed characteristics as using a three-phase 200 V power input. Refer to the diagram of each servomotor force-speed characteristics in  *$\Sigma$ -V Series Product Catalog* (No.: KAEP S800000 42).

#### (2) Main Circuit Power Input Terminals

Connect a single-phase 200 V power supply of the following specifications to L1 and L2 terminals.

The specifications of the power supplies other than the main circuit power supply are the same as for three-phase power supply input.

Terminal Symbols	Name	Model SGDV-□□□A	Specifications
L1, L2	Main circuit power input terminals	R70, R90, 1R6, 2R8, 5R5	Single-phase 200 to 230 V, +10 to -15%, 50/60 Hz
L3*			None

\* Do not use L3 terminal.

#### (3) Main Circuit Wire for SERVOPACKs

Terminal Symbols	Name	Model SGDV-□□□A (Unit: mm <sup>2</sup> )				
		R70	R90	1R6	2R8	5R5
L1, L2	Main circuit power input terminals	HIV1.25			HIV2.0	
L1C, L2C	Control power input terminals	HIV1.25				
U, V, W	Servomotor connection terminals	HIV1.25			HIV2.0	
B1/⊕, B2	External regenerative resistor connection terminals	HIV1.25				
⊕	Ground terminal	HIV2.0 or larger				

## (4) Wiring Example with Single-phase 200-V Power Supply Input

## ■ SERVOPACK with Single-phase, 200-V Power Supply

Applicable SERVOPACK Model: SGD V-R70A, -R90A, -1R6A, -2R8A, and -5R5A

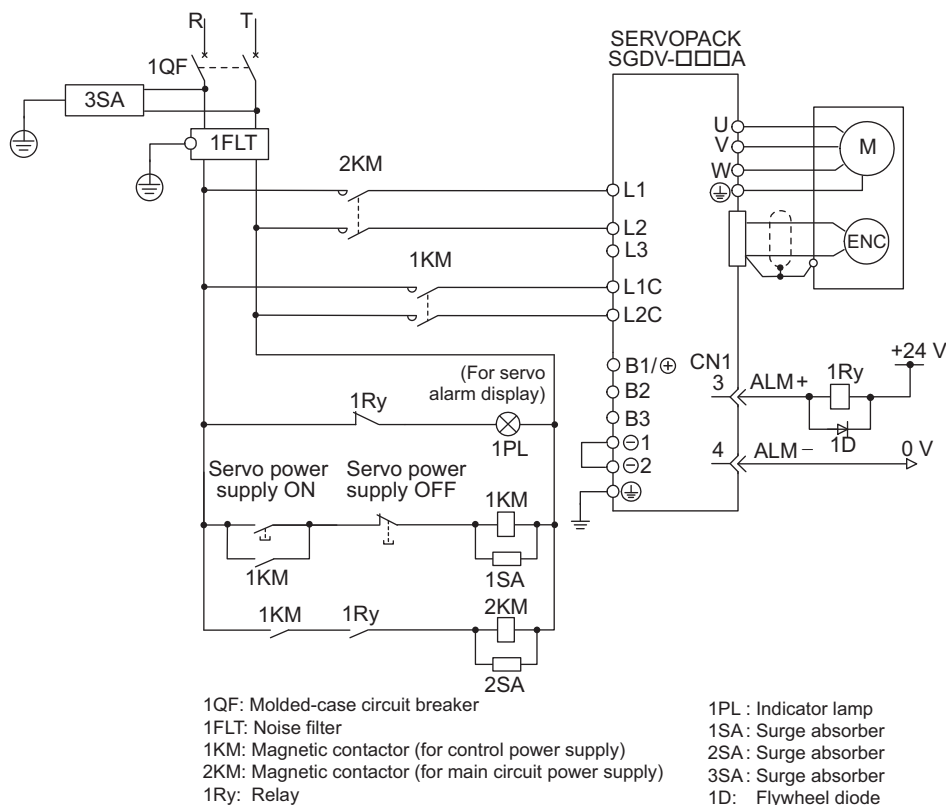

## (5) Power Supply Capacities and Power Losses

The following table shows SERVOPACK's power supply capacities and power losses when using single-phase 200 V power supply.

Main Circuit Power Supply	Maximum Applicable Servomotor Capacity [kW]	SERVOPACK Model SGD V-	Power Supply Capacity per SERVOPACK [kVA]	Output Current [Arms]	Main Circuit Power Loss [W]	Regenerative Resistor Power Loss [W]	Control Circuit Power Loss [W]	Total Power Loss [W]
Single-phase, 200 V	0.05	R70A	0.2	0.66	5.2	-	17	22.2
	0.1	R90A	0.3	0.91	7.4			24.4
	0.2	1R6A	0.7	1.6	13.7			30.7
	0.4	2R8A	1.2	2.8	24.9			41.9
	0.75	5R5A	1.9	5.5	52.7	8	77.7	

- Note 1. SGD V-R70A, -R90A, -1R6A, and -2R8A SERVOPACKs do not have built-in regenerative resistors. If the regenerative energy exceeds the specified value, connect an external regenerative resistor between B1/⊕ and B2.
2. Regenerative resistor power losses are allowable losses. Take the following action if this value is exceeded.
- Remove the lead or shorting bar between terminals B2 and B3 on the SERVOPACK main circuit of SGD V-5R5A SERVOPACKs.
  - Install an external regenerative resistor between external regenerative resistor connection terminals B1/⊕ and B2.
3. External regenerative resistors are not included.

## (6) How to Select Molded-case Circuit Breaker and Fuse Capacities

The following table shows the SERVOPACK's current capacities and inrush current when using single-phase 200 V power supply. Use these values as a basis for selecting the molded-case circuit breaker and fuse.

Main Circuit Power Supply	Maximum Applicable Servomotor Capacity [kW]	SERVOPACK Model SGD V-	Power Supply Capacity per SERVOPACK [kVA]	Current Capacity		Inrush Current	
				Main Circuit [Arms]	Control Circuit [Arms]	Main Circuit [A0-p]	Control Circuit [A0-p]
Single-phase, 200 V	0.05	R70A	0.2	2	0.2	33	70
	0.1	R90A	0.3	2			
	0.2	1R6A	0.7	3			
	0.4	2R8A	1.2	5			
	0.75	5R5A	1.9	9			33

Note: To comply with the EU low voltage directive, connect a fuse to the input side as protection against accidents caused by short-circuits. Select the fuse for the input side that are compliant with UL standards.

The table above also provides the net values of current capacity and inrush current. Select a fuse and a molded-case circuit breaker which meet the breaking characteristics shown below.

- Main circuit, control circuit: No breaking at three times the current values shown in the table for 5 s.
- Inrush current: No breaking at the current values shown in the table for 20 ms.

### 3.1.4 Using the SERVOPACK with a DC Power Input

#### (1) Parameter Setting

When using a DC power supply, make sure to set the parameter Pn001.2 to 1 (DC power input supported) before inputting DC power.

Parameter	Meaning	When Enabled	Classification
Pn001	n.□0□□	After restart	Setup
	n.□1□□		

Observe the following precautions.

 WARNING
<ul style="list-style-type: none"> <li>• Either AC or DC power can be input to the 200-V, 400-V SERVOPACKs. Always set Pn001.2 to 1 to specify a DC power input before inputting DC power. Only AC power can be input to the 100-V SERVOPACKs. If DC power is input without changing the parameter setting, the SERVOPACK's internal elements will burn and may cause fire or damage to the equipment.</li> <li>• With a DC power input, time is required to discharge electricity after the main power supply is turned OFF. A high residual voltage may remain in the SERVOPACK after the power supply is turned OFF. Be careful not to get an electric shock.</li> <li>• Install fuses on the wires if DC power is used.</li> <li>• Servomotor returns a regenerated energy to the power supply. The SERVOPACK that can use a DC power supply is not capable of processing the regenerated energy. Provide measures to process the regenerated energy on the power supply.</li> <li>• With a DC power input, connect an external inrush current limit circuit. Failure to observe this caution may result in damage to the equipment.</li> </ul>

#### (2) DC Power Supply Input Terminals for the Main and Control Circuits

- Three-phase, 200 V for SGD□-□□□A  
(□□□ = R70, R90, 1R6, 2R8, 3R8, 5R5, 7R6, 120, 180, 200, 330)

Terminal Symbols	Name	Specifications
B1/ ⊕	Main circuit positive terminal	270 to 320 VDC
⊖ 2	Main circuit negative terminal	0 VDC
L1C, L2C	Control power input terminal	200 to 230 VAC

- Three-phase, 200-V for SGD□V-550A

Terminal Symbols	Name	Specifications
B1/ ⊕	Main circuit positive terminal	270 to 320 VDC
⊖	Main circuit negative terminal	0 VDC
L1C, L2C	Control power input terminal	200 to 230 VAC

- Three-phase, 400 V for SGD□V-□□□D  
(□□□ = 1R9, 3R5, 5R4, 8R4, 120, 170, 260)

Terminal Symbols	Name	Specifications
B1/ ⊕	Main circuit positive terminal	513 to 648 VDC
⊖ 2	Main circuit negative terminal	0 VDC
24 V, 0 V	Control power input terminal	24 VDC ±15%

(3) Wiring Example with DC Power Supply Input

■ 200-V SERVOPACK SGD V-□□□A

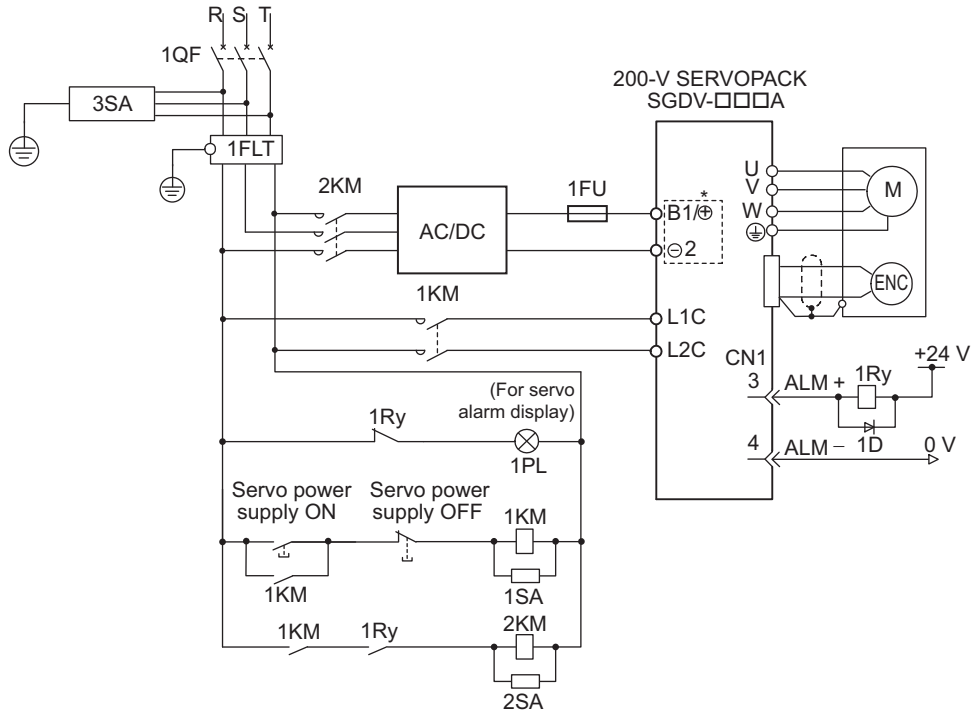

- 1QF: Molded-case circuit breaker
- 1FLT: Noise filter
- 1KM: Magnetic contactor (for control power supply)
- 2KM: Magnetic contactor (for main circuit power supply)
- 1Ry: Relay
- 1PL: Indicator lamp
- 1SA: Surge absorber
- 2SA: Surge absorber
- 3SA: Surge absorber
- 1D: Flywheel diode

\* Terminal names differ depending on model of SERVOPACK. Refer to (2) DC Power Supply Input Terminals for the Main and Control Circuits.

■ 400-V SERVOPACK SGD V-□□□D

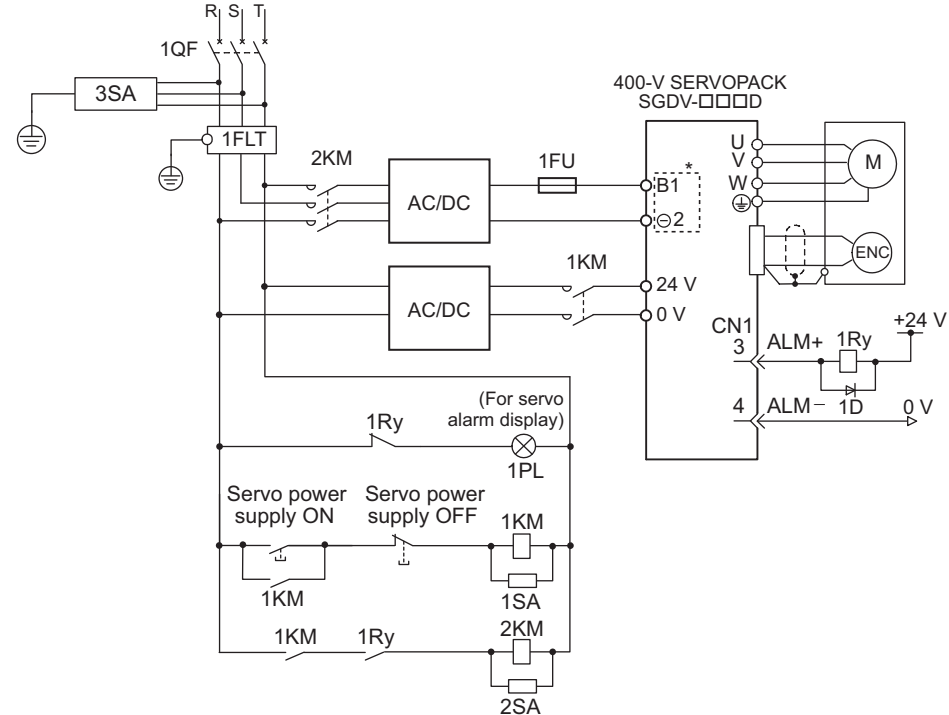

- 1QF: Molded-case circuit breaker
- 1FLT: Noise filter
- 1KM: Magnetic contactor (for control power supply)
- 2KM: Magnetic contactor (for main circuit power supply)
- 1Ry: Relay
- 1PL: Indicator lamp
- 1SA: Surge absorber
- 2SA: Surge absorber
- 3SA: Surge absorber
- 1D: Flywheel diode

\* Terminal names differ depending on model of SERVOPACK. Refer to (2) DC Power Supply Input Terminals for the Main and Control Circuits.

### 3.1.5 Using More Than One SERVOPACK

This section shows an example of the wiring and the precautions when more than one SERVOPACK is used.

#### (1) Wiring Example

Connect the alarm output (ALM) terminals for three SERVOPACKs in series to enable alarm detection relay 1Ry to operate. When the alarm occurs, the ALM output signal transistor is turned OFF.

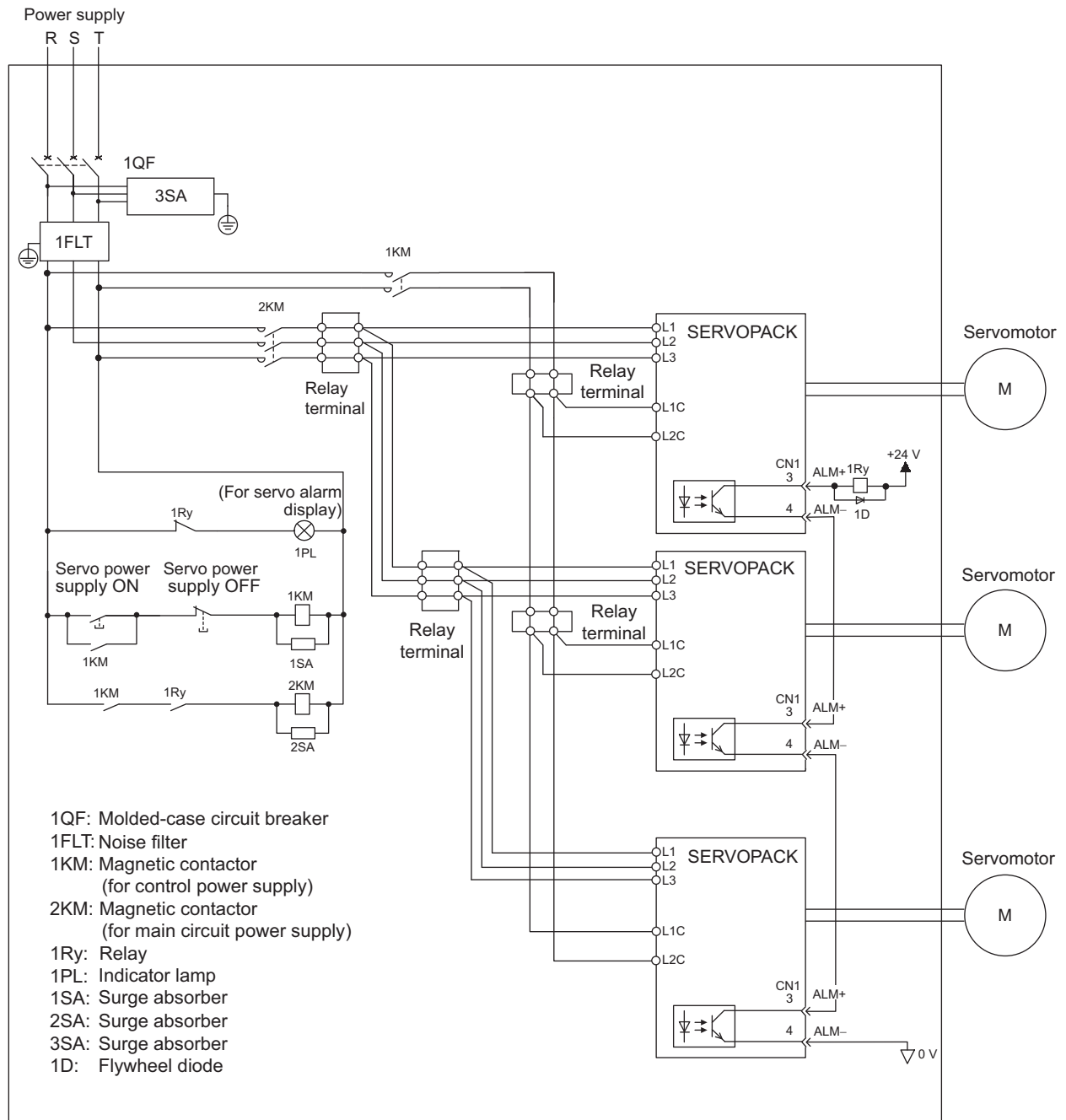

#### (2) Precautions

Multiple SERVOPACKs can share a single molded-case circuit breaker (1QF) or noise filter. Always select a molded-case circuit breaker or noise filter that has enough capacity for the total power supply capacity (load conditions) of the SERVOPACKs.

### 3.1.6 General Precautions for Wiring



#### CAUTION

- Use shielded twisted-pair cables or screened unshielded twisted-pair cables for I/O signal cables and linear scale connection cables.
- Make sure that the length of each cable is equal to or shorter than the maximum wiring length listed here.
  - I/O signal cables: 3 m
  - Connection cables for linear servomotor main circuit: 20 m
  - Connection cables for serial converter unit: 20 m
  - Connection cables for linear scale: 15 m
  - Connection cables for hall sensor: 15 m
  - Control power supply cables for the SERVOPACK with a 400-V power supply (+24 V, 0 V): 10 m



#### IMPORTANT

- Use a molded-case circuit breaker (1QF) or fuse to protect the main circuit.  
The SERVOPACK connects directly to a commercial power supply; it is not isolated through a transformer or other device.  
Always use a molded-case circuit breaker (1QF) or fuse to protect the servo system from accidents involving different power system voltages or other accidents.
- Install a ground fault detector.  
The SERVOPACK does not have a built-in protective circuit for grounding. To configure a safer system, install a ground fault detector against overloads and short-circuiting, or install a ground fault detector combined with a molded-case circuit breaker.
- Do not turn the power ON and OFF more than necessary.
  - Do not use the SERVOPACK for applications that require the power to turn ON and OFF frequently. Such applications will cause elements in the SERVOPACK to deteriorate.
  - As a guideline, at least one hour should be allowed between the power being turned ON and OFF once actual operation has been started.

To ensure safe, stable application of the servo system, observe the following precautions when wiring.

- Use the connection cables specified in the *Σ-V Series Product Catalog* (No.: KAEP S800000 42). Design and arrange the system so that each cable will be as short as possible.
- Observe the following precautions when wiring the ground.
  - Use a cable as thick as possible (at least 2.0 mm<sup>2</sup>).
  - Grounding to a resistance of 100 Ω or less for 100-V, 200-V SERVOPACKs, 10 Ω or less for 400-V SERVOPACKs is recommended.
  - Be sure to ground at only one point.
  - Ground the servomotor directly if the servomotor is insulated from the machine.
- Do not apply bending stress or tension to the signal cables when you handle them. The core wires are very thin (0.2 mm<sup>2</sup> or 0.3 mm<sup>2</sup>).

## 3.2 I/O Signal Connections

This section describes the names and functions of I/O signals (CN1). Also connection examples by control method are shown.

### 3.2.1 I/O Signal (CN1) Names and Functions

 <b>IMPORTANT</b>	<p>Regarding the allocation and use of I/O signals, they differ in accordance with the connected option module. For details, refer to the manual for the command option module that is connected.</p>
---	---

The following table shows the names and functions of I/O signals (CN1).

#### (1) Input Signals

Signal Name	Pin No.	Name	Function	Reference Section
P-OT	7	Forward run prohibited signal	Overtravel prohibited: Stops linear servomotor when movable part travels beyond the allowable range of motion.	4.2.2
N-OT	8	Reverse run prohibited signal		
/SI3	9	Command option module input 3	Connects the external input signal used in the Command Option Module.	-
/SI4	10	Command option module input 4		
/SI5	11	Command option module input 5		
/SI6	12	Command option module input 6		
+24VIN	6	Control power supply input for sequence signals	Control power supply input for sequence signals. Allowable voltage fluctuation range: 11 to 25 V Note: The +24-V power supply is not included.	3.4.1
/SI0	13	General-purpose input	Connects the external input signal used in the Command Option Module.	-

- Note 1. You can change the allocations of the input signals (/SI0, /SI3 to /SI6, P-OT, and N-OT). For details, refer to 3.3.1 *Input Signal Allocations*.
- If the Forward run prohibited/ Reverse run prohibited function is used, the SERVOPACK is stopped by software controls, not by electrical or mechanical means. If the application does not satisfy the safety requirements, add an external circuit for safety reasons as required.

## (2) Output Signals

Signal	Pin No.	Name	Function	Reference Section
ALM+ ALM-	3 4	Servo alarm output signal	Turns OFF when an error is detected.	–
/BK+ (/SO1+) /BK- (/SO1-)	1 2	Brake interlock signal	Controls the brake. The brake is released when the signal turns ON (closed). Allocation can be changed to general-purpose output signals (/SO1+, /SO1-).	4.2.3
/SO2+ /SO2- /SO3+ /SO3-	23 24 25 26	General-purpose output signal	Used for general-purpose output. Note: Set the parameter to allocate a function.	–
/COIN /V-CMP /TGON /S-RDY /CLT /VLT /WARN /NEAR	Can be allocated	Positioning completion Speed coincidence detection Movement detection servo ready Force limit Speed limit detection Warning Near	The allocation of an output signal to a pin can be changed in accordance with the function required.	–
PAO /PAO	17 18	Phase-A signal	Encoder output pulse signals with 90° phase differential	4.2.5 4.5.2
PBO /PBO	19 20	Phase-B signal		
PCO /PCO	21 22	Phase-C signal	Origin pulse output signal	
SG	16	Signal ground	Connects to the 0 V pin on the control circuit of the host controller.	–
FG	Shell	Frame ground	Connected to frame ground if the shielded wire of the I/O signal cable is connected to the connector shell.	–

Note: You can change the allocations of the output signals (/SO1 to /SO3). For details, refer to 3.3.2 *Output Signal Allocations*.

**3.2.2 Safety Function Signal (CN8) Names and Functions**

The following table shows the terminal layout of safety function signals (CN8).

Signal Name	Pin No.	Function	
/HWBB1+	4	Hard wire baseblock input 1	For hard wire baseblock input. Baseblock (motor current off) when OFF.
/HWBB1-	3		
/HWBB2+	6	Hard wire baseblock input 2	
/HWBB2-	5		
EDM1+	8	Monitored circuit status output 1	ON when the /HWBB1 and the /HWBB2 signals are input and the SERVOPACK enters a baseblock state.
EDM1-	7		
–	1*	–	
–	2*	–	

\* Do not use pins 1 and 2 because they are connected to the internal circuits.

### 3.2.3 Example of I/O Signal Connections

The following diagram shows a typical connection example.

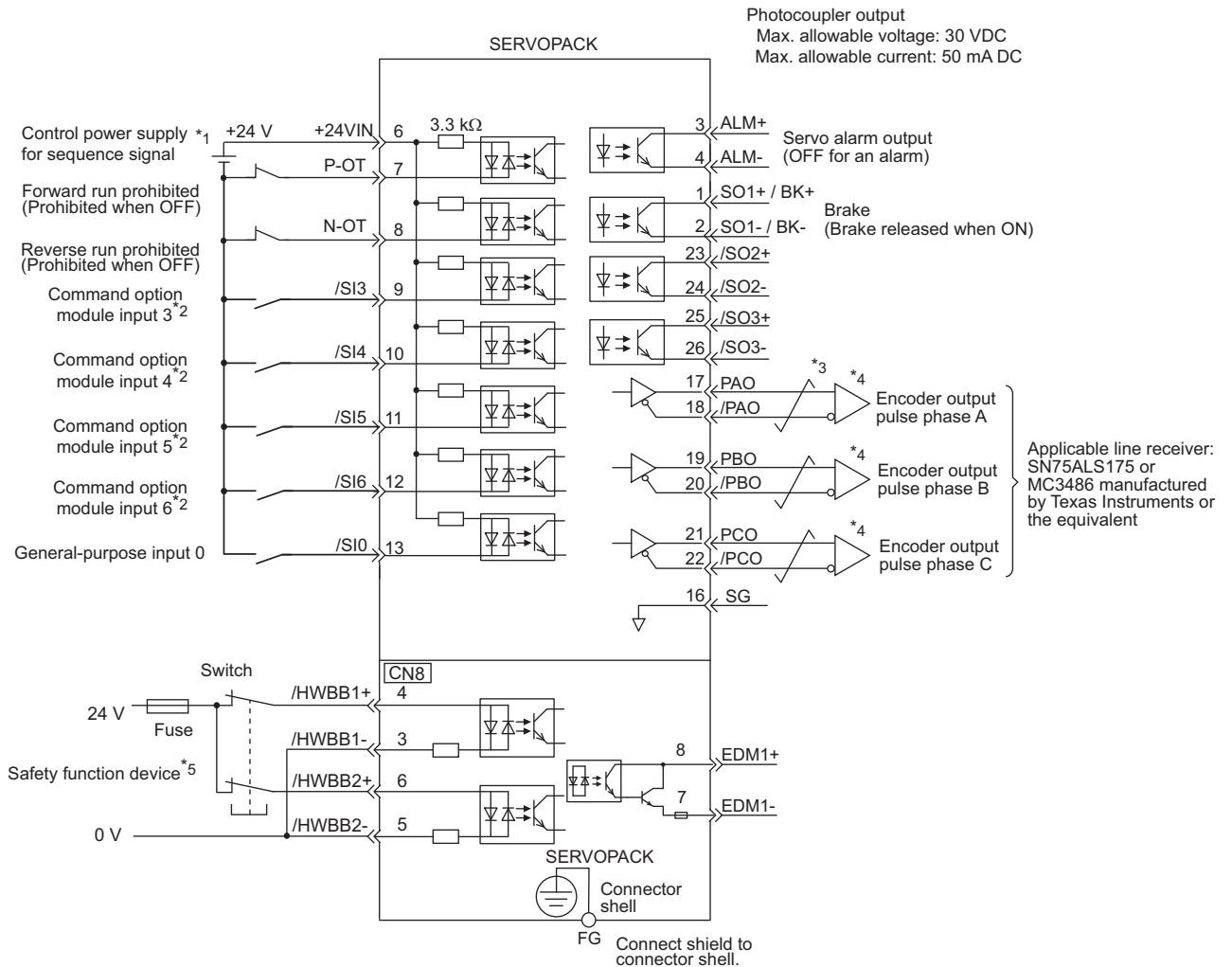

- \*1. The 24-VDC power supply is not included. Use a 24-VDC power supply with double insulation or reinforced insulation.
- \*2. For details, refer to the manual of the connected command option module.
- \*3. represents twisted-pair wires.
- \*4. Always use line receivers to receive the output signals.
- \*5. When using a safety function device, refer to 4.7 *Safety Function*. When not using a safety function device, leave the safety function's jumper connector that is included with the SERVOPACK inserted in CN8.

Note: You can change the allocations of the input signals /SI0, /SI3 to /SI6, P-OT, and N-OT and the output signals /SO1, /SO2, and /SO3 by using the parameters. For details, refer to 3.3.1 *Input Signal Allocations* and 3.3.2 *Output Signal Allocations*.

### 3.3 I/O Signal Allocations

This section describes the I/O signal allocations.

#### 3.3.1 Input Signal Allocations

 <p>IMPORTANT</p>	<ul style="list-style-type: none"><li>• Inverting the polarity of the forward run prohibited and reverse run prohibited signals from the factory setting will prevent the overtravel function from working in case of signal line disconnections or other failures. If this setting is absolutely necessary, check the operation and confirm that there are no safety problems.</li><li>• When two or more signals are allocated to the same input circuit, input signal level is valid for all allocated signals, resulting in an unexpected machine operation.</li></ul>
--	--

Input signals are allocated as shown in the following table.

Refer to the *Interpreting the Input Signal Allocation Tables* and change the allocations accordingly.

<Interpreting the Input Signal Allocation Tables>

Level at which input signal allocations are valid.

The parameter set values to be used are shown. Signals are allocated to CN1 pins according to the selected set values. Values in cells in bold lines are the factory settings.

Input Signal Names and Parameters	Validity Level	Input Signal	CN1 Pin Numbers							Connection Not Required (SERVOPACK judges the connection)	
			13	7	8	9	10	11	12	Always ON	Always OFF
Forward Run Prohibited <b>Pn50A.3</b>	H	P-OT	0	<b>1</b>	2	3	4	5	6	7	8
	L	/P-OT	9	A	B	C	D	E	F		

If always ON (7) or always OFF (8) is set, signals will be processed in the SERVOPACK, which will eliminate the need for wiring changes.

Input Signal Names and Parameters	Validity Level	Input Signal	CN1 Pin Numbers							Connection Not Required (SERVOPACK judges the connection)	
			13	7	8	9	10	11	12	Always ON	Always OFF
Forward Run Prohibited <b>Pn50A.3</b>	H	P-OT	0	<b>1</b>	2	3	4	5	6	7	8
	L	/P-OT	9	A	B	C	D	E	F		
Reverse Run Prohibited <b>Pn50B.0</b>	H	N-OT	0	1	<b>2</b>	3	4	5	6	7	8
	L	/N-OT	0	A	B	C	D	E	F		
Forward External Force Limit <b>Pn50B.2</b>	L	/P-CL	0	1	2	3	4	5	6	7	<b>8</b>
	H	P-CL	9	A	B	C	D	E	F		
Reserve External Force Limit <b>Pn50B.3</b>	L	/N-CL	0	1	2	3	4	5	6	7	<b>8</b>
	H	N-CL	9	A	B	C	D	E	F		
Command Option Module Input 3 <sup>*1</sup> <b>Pn511.0</b>	L	/SI3	0	1	2	<b>3</b>	4	5	6	7	8
	H	SI3	9	A	B	C	D	E	F		
Command Option Module Input 4 <sup>*1</sup> <b>Pn511.1</b>	L	/SI4	*2	*2	*2	*2	<b>4</b>	5	6	-	0 to 3 and 7 to C
	H	SI4	*2	*2	*2	*2	D	E	F		
Command Option Module Input 5 <sup>*1</sup> <b>Pn511.2</b>	L	/SI5	*2	*2	*2	*2	4	<b>5</b>	6	-	0 to 3 and 7 to C
	H	SI5	*2	*2	*2	*2	D	E	F		
Command Option Module Input 6 <sup>*1</sup> <b>Pn511.3</b>	L	/SI6	*2	*2	*2	*2	4	5	<b>6</b>	-	0 to 3 and 7 to C
	H	SI6	*2	*2	*2	*2	D	E	F		

\*1. For details, refer to the manual of the connected command option module.  
 \*2. These pins cannot be allocated. The setting is not valid.

### 3.3.2 Output Signal Allocations



**IMPORTANT**

- The signals not detected are considered as "Invalid." For example, Positioning Completion (/COIN) signal in speed control is "Invalid."
- Inverting the polarity of the brake signal (/BK), i.e. positive logic, will prevent the holding brake from working in case of its signal line disconnection. If this setting is absolutely necessary, check the operation and confirm that there are no safety problems.
- When two or more signals are allocated to the same output circuit, a signal is output with OR logic circuit.

Output signals are allocated as shown in the following table.

Refer to the *Interpreting the Output Signal Allocation Tables* and change the allocations accordingly.

<Interpreting the Output Signal Allocation Tables>

The parameter set values to be used are shown. Signals are allocated to CN1 pins according to the selected set values. Values in cells in bold lines are the factory settings.

Output Signal Names and Parameters	Output Signal	CN1 Pin Numbers			Invalid (not use)
		1 (2)	23 (24)	25 (26)	
Brake <b>Pn50F.2</b>	/BK	1	2	3	0

Output Signal Names and Parameters	Output Signal	CN1 Pin Numbers			Invalid (not use)
		1 (2)	23 (24)	25 (26)	
Positioning Completion <b>Pn50E.0</b>	/COIN	1	2	3	0
Speed Coincidence Detection <b>Pn50E.1</b>	/V-CMP	1	2	3	0
Movement Detection <b>Pn50E.2</b>	/TGON	1	2	3	0
Servo Ready <b>Pn50E.3</b>	/S-RDY	1	2	3	0
Force Limit Detection <b>Pn50F.0</b>	/CLT	1	2	3	0
Speed Limit Detection <b>Pn50F.1</b>	/VLT	1	2	3	0
Brake <b>Pn50F.2</b>	/BK	1	2	3	0
Warning <b>Pn50F.3</b>	/WARN	1	2	3	0
Near <b>Pn510.0</b>	/NEAR	1	2	3	0
<b>Pn512.0=1</b>	Polarity inversion of CN1-1(2)				0
<b>Pn512.1=1</b>	Polarity inversion of CN1-23(24)				(Not invert at factory setting)
<b>Pn512.2=1</b>	Polarity inversion of CN1-25(26)				(Not invert at factory setting)

### 3.4 Examples of Connection to Host Controller

This section shows examples of SERVOPACK I/O signal connection to the host controller.

#### 3.4.1 Sequence Input Circuit

##### (1) Photocoupler Input Circuit

CN1 connector terminals 6 to 13 are explained below.

The sequence input circuit interface is connected through a relay or open-collector transistor circuit. When connecting through a relay, use a low-current relay. If a low-current relay is not used, a faulty contact may result.

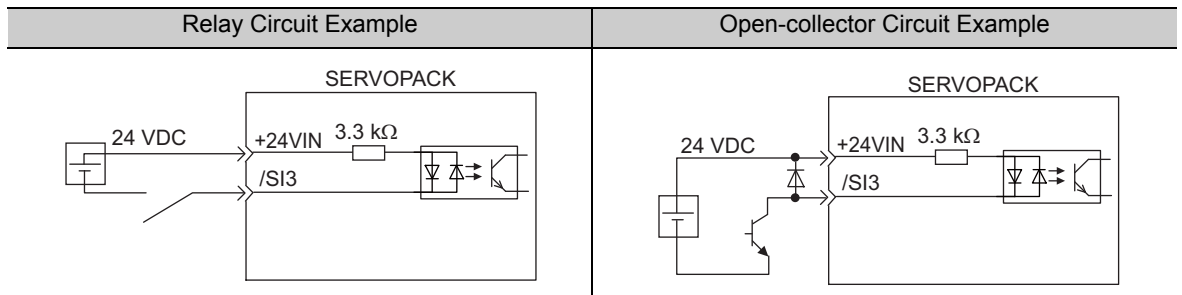

Note: The 24 VDC external power supply capacity must be 50 mA minimum.

The SERVOPACK’s input circuit uses bidirectional photocoupler. Select either the sink circuit or the source circuit according to the specifications required for each machine.

- Note 1. The connection examples in 3.2.3 Example of I/O Signal Connections are sink circuit connections.
- 2. The ON/OFF polarity differs between when a sink circuit is connected and when a source circuit is connected.

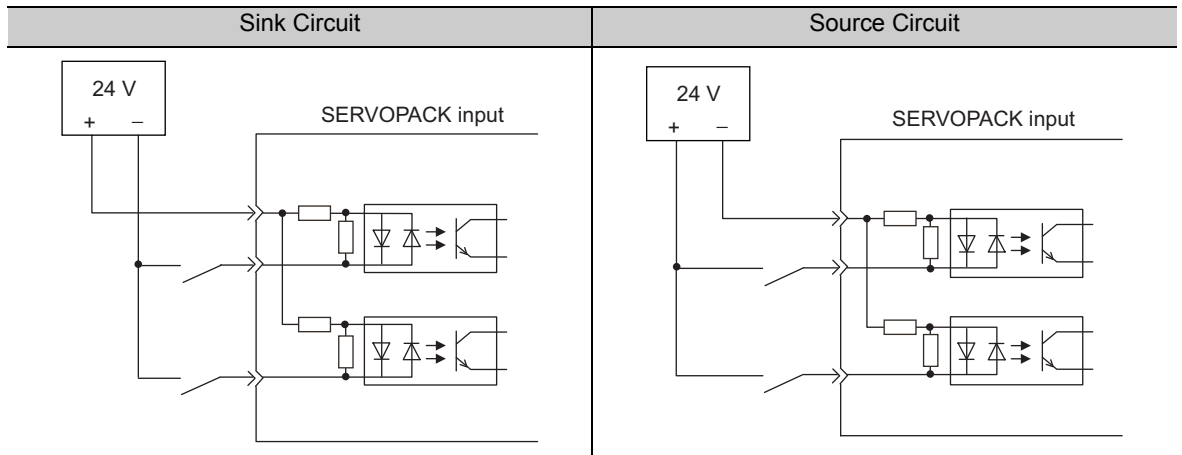

Input Signal Polarities				Input Signal Polarities			
Signal	Level	Voltage Level	Contact	Signal	Level	Voltage Level	Contact
ON	Low (L) level	0 V	Close	ON	High (H) level	24 V	Close
OFF	High (H) level	24 V	Open	OFF	Low (L) level	0 V	Open

### (2) Safety Input Circuit

As for wiring input signals for safety function, input signals make common 0 V. It is necessary to make an input signal redundant.

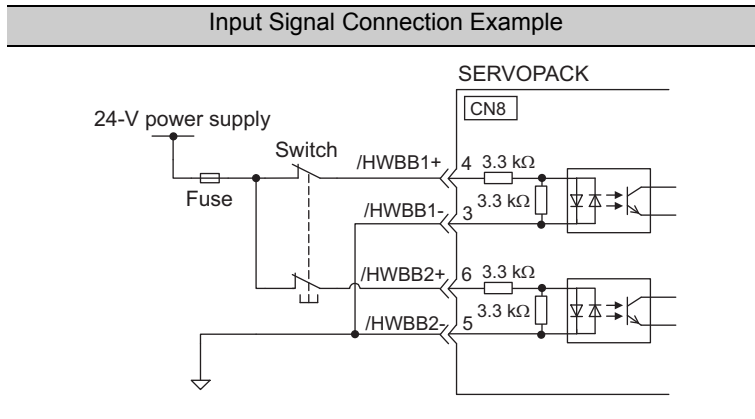

### 3.4.2 Sequence Output Circuit

Three types of SERVOPACK output circuit are available.

 <b>IMPORTANT</b>	<p>Incorrect wiring or incorrect voltage application to the output circuit may cause short-circuit.</p> <p>If a short-circuit occurs as a result of any of these causes, the holding brake will not work. This could damage the machine or cause an accident resulting in death or injury.</p>
----------------------	--

#### (1) Photocoupler Output Circuit

Photocoupler output circuits are used for servo alarm (ALM), servo ready (/S-RDY), and other sequence output signal circuits. Connect a photocoupler output circuit through a relay or line receiver circuit.

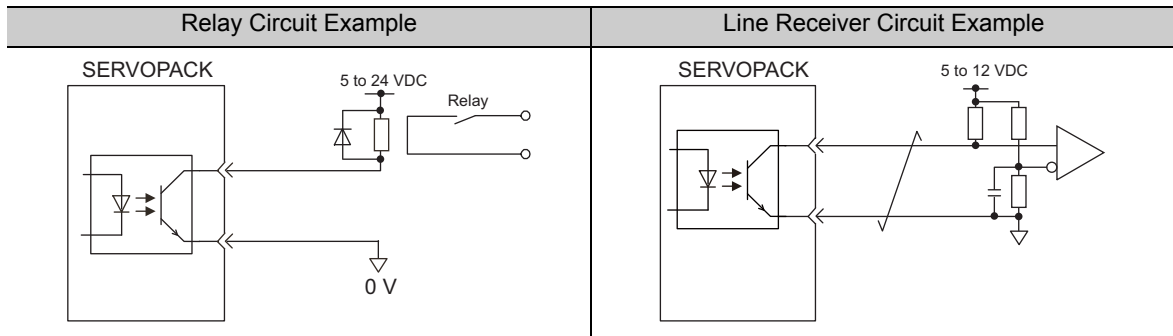

Note: The maximum allowable voltage and current range of the photocoupler output circuit are as follows:

- Maximum allowable voltage: 30 VDC
- Current range: 5 to 50 mA DC

## (2) Line Driver Output Circuit

CN1 connector terminals, 17-18 (phase-A signal), 19-20 (phase-B signal), and 21-22 (phase-C signal) are explained below.

These terminals output the following signals via the line-driver output circuits.

- Output signals for which linear scale's serial data is converted as two phases pulses (PAO, /PAO, PBO, /PBO)
- Origin pulse signals (PCO, /PCO)

Connect the line-driver output circuit through a line receiver circuit at the host controller.

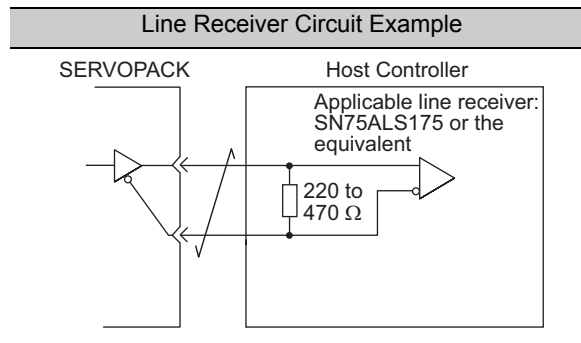

## (3) Safety Output Circuit

The external device monitor (EDM1) for safety output signals is explained below.

A configuration example for the EDM1 output signal is shown in the following diagram.

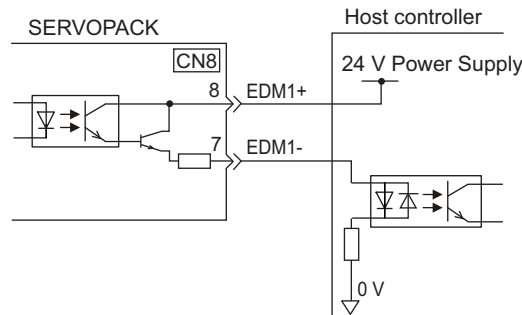

### ■ Specifications

Type	Signal Name	Pin No.	Output Status	Meaning
Output	EDM1	CN8-8 CN8-7	ON	Both the /HWBB1 and /HWBB2 signals are working normally.
			OFF	The /HWBB1 signal, the /HWBB2 signal, or both are not working normally.

Electrical characteristics of EDM1 signal are as follows.

Items	Characteristic	Remarks
Maximum Allowable Voltage	30 VDC	—
Maximum Allowable Current	50 mADC	—
Maximum Voltage Drop at ON	1.0 V	Voltage between EDM1+ to EDM1- at current is 50 mA.
Maximum Delay Time	20 ms	Time from the change in /HWBB1 or /HWBB2 until the change in EDM1.

### 3.5 Wiring Communications Using Command Option Modules

The following diagram shows an example of connections between a host controller and a SERVOPACK using communications with command option modules.

Connect the connector of the communications cable to the command option module.

For details, refer to the manual of the connected command option module.

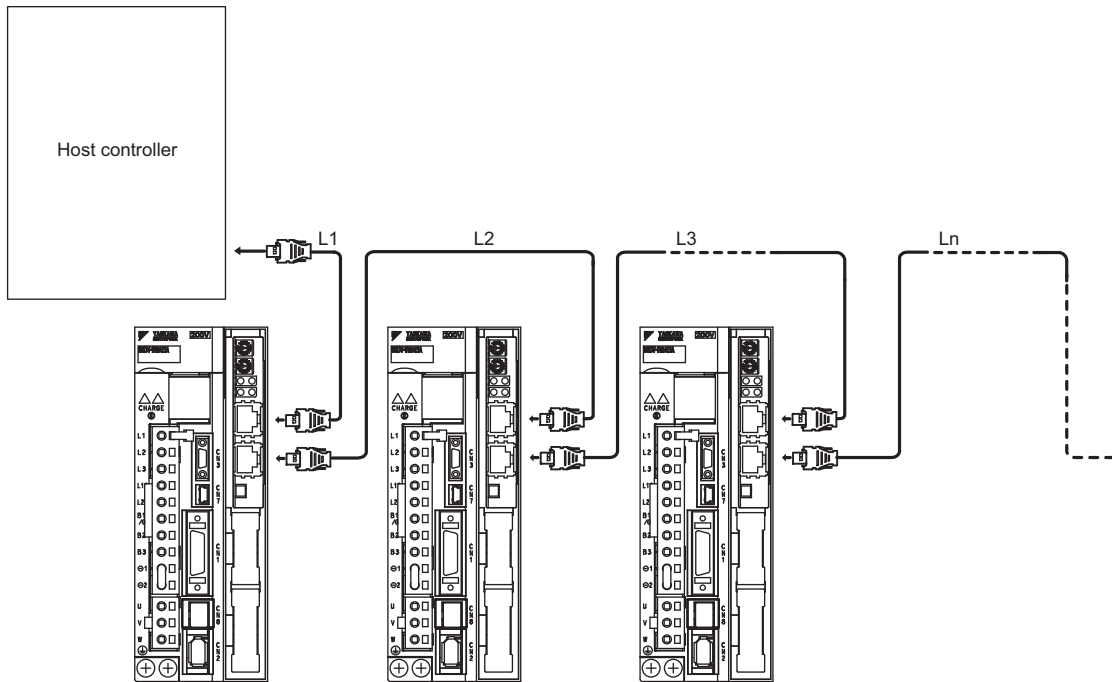

## 3.6 Linear Scale Connection

This section describes the linear scale signal (CN2) names, functions, and connection examples.

### 3.6.1 Linear Scale Signal (CN2) Names and Functions

The following table shows the names and functions of linear scale signals (CN2).

Signal Name	Pin No.	Function
PG5V	1	Linear scale power supply +5 V
PG0V	2	Linear scale power supply 0 V
–	3*	–
–	4*	–
PS	5	Serial data (+)
/PS	6	Serial data (-)
Shield	Shell	–

\* Do not use pins 3 and 4.

### 3.6.2 Serial Converter Unit

#### (1) Characteristics and Specifications

The following table shows the characteristics and specifications of the serial converter unit.

Items		JZDP-D00□-□□□-E	JZDP-G00□-□□□-E
Electrical Characteristics	Power Supply Voltage	+5.0 V±5%, ripple content 5% max.	
	Current Consumption	120 mA Typ. 350 mA max.	
	Signal Resolution	1/256 pitch of input 2-phase sine wave	1/4096 pitch of input 2-phase sine wave pitch
	Max. Response Frequency	250 kHz	100 kHz
	Analog Input Signals* (cos, sin, Ref)	Differential input amplitude: 0.4 V to 1.2 V Input signal level: 1.5 V to 3.5 V	
	Hall Sensor Input Signal	CMOS level	
	Output Signal	Position data, hall sensor information, alarms	
	Output Method	Serial data communications	
Output Circuit	Balanced type transceiver (SN75LBC176 or the equivalent), internal terminating resistor: 120 Ω		
Mechanical Characteristics	Approx. Mass	150 g	
	Vibration Resistance	98 m/s <sup>2</sup> max. (10 to 2500 Hz) in three directions	
	Shock Resistance	980 m/s <sup>2</sup> , (11 ms) two times in three directions	
Environmental Conditions	Surrounding Air Temperature	0°C to 55°C	
	Storage Temperature	-20°C to +80°C	
	Humidity	20% to 90%RH (without condensation)	

\* Input a value within the specified range. Otherwise, incorrect position information is output, and the device may be damaged.

(2) Model Designations

The following figure shows the model designations of the serial converter unit.

JZDP - □00□ - □□□ - E

Serial Converter Unit Model		
Code	Applicable Linear Scale	Hall Sensor
D003 G003	Manufactured by Heidenhain	None
D005 G005	Manufactured by Renishaw plc	None
D006 G006	Manufactured by Heidenhain	Provided
D008 G008	Manufactured by Renishaw plc	Provided

Applicable Linear Servomotor					
Servomotor Model		Symbol	Servomotor Model		Symbol
SGLGW - (Coreless)  When a Standard force magnetic way is used.	30A050C	250	SGLTW- (Iron core, T-type)	20A170A	011
	30A080C	251		20A320A	012
	40A140C	252		20A460A	013
	40A253C	253		35A170A	014
	40A365C	254		35A320A	015
	60A140C	258		35A460A	016
	60A253C	259		35A170H	105
	60A365C	260		35A320H	106
	90A200C	264		50A170H	108
	90A370C	265		50A320H	109
SGLGW - + SGLGM - □-M (Coreless)  When a high-force magnetic way is used.	40A140C	255	SGLC- (Cylinder type)	40A400B	185
	40A253C	256		40A600B	186
	40A365C	257		80A400B	187
	60A140C	261		80A600B	188
	60A253C	262		35D170H	193
	60A365C	263		35D320H	194
	20A090A	017		50D170H	195
	20A120A	018		50D320H	196
	35A120A	019		40D400B	197
	35A230A	020		40D600B	198
SGLFW - (Iron core, F-type)	50A200B	181	SGLC- (Cylinder type)	80D400B	199
	50A380B	182		80D600B	200
	1ZA200B	183		D16A085AP	354
	1ZA380B	184		D16A115AP	373
	35D120A	211		D16A145AP	356
	35D230A	212		D20A100AP	357
	50D200B	189		D20A135AP	358
	50D380B	190		D20A170AP	359
	1ZD200B	191		D25A125AP	360
	1ZD380B	192		D25A170AP	374
			D25A215AP	362	
			D32A165AP	363	
			D32A225AP	364	
			D32A285AP	365	

### (3) Analog Signal Input Timing

Input the analog signals with the timing shown in the following figure.

The /cos and /sin signals are the differential signals when the cos and sin signals are shifted 180°. The specifications of the cos, /cos, sin, and /sin signals are identical except for the phases.

The Ref and /Ref signals are input to the comparator. Input a signal that will exceed the hysteresis of the comparator (i.e., the broken lines in the following figure).

When they are crossed, the output data will be counted up.

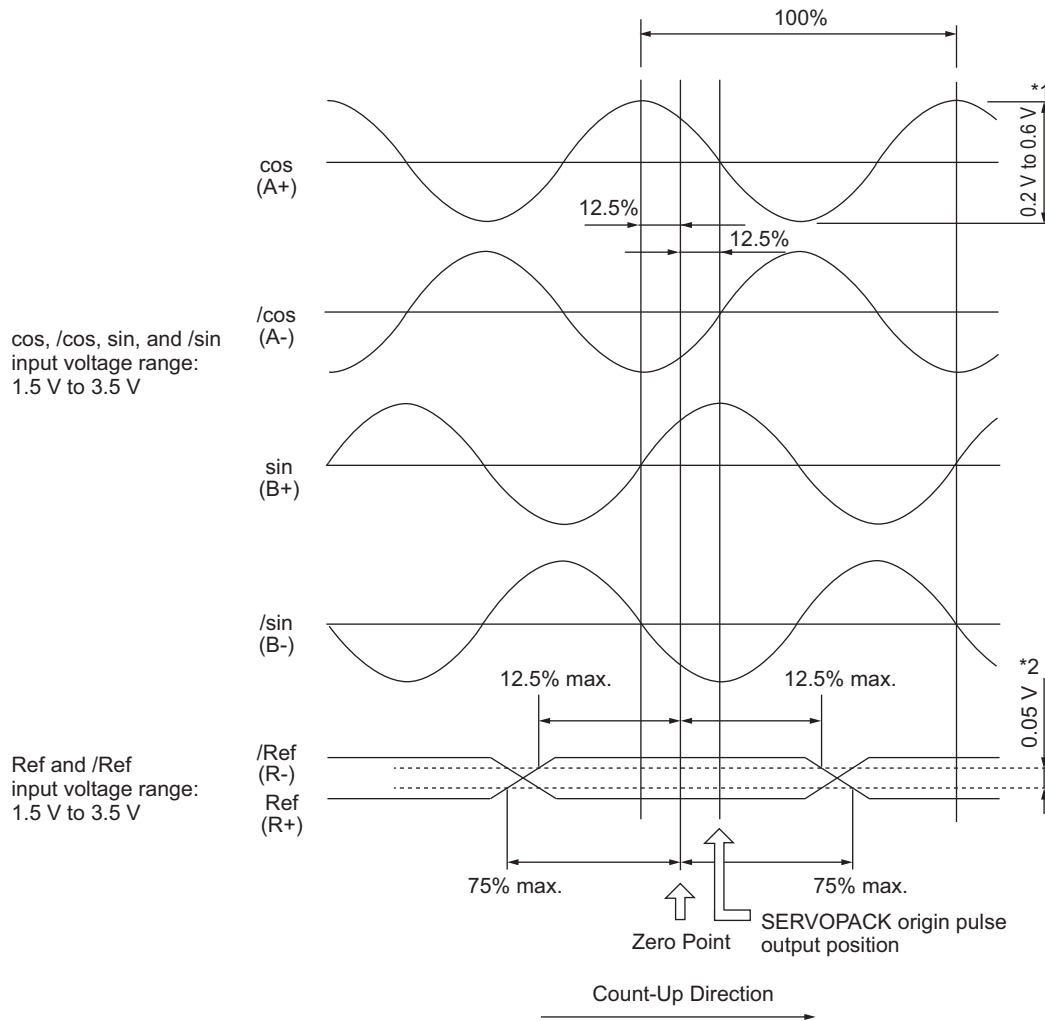

- \*1. If the analog signal amplitude declines to approximately 0.35 V because of differential amplitude, the serial converter unit will output an alarm.
- \*2. This is the hysteresis width.



#### IMPORTANT

- Never perform insulation resistance and withstand voltage tests.
- When low-voltage analog signals are input to the serial converter unit, noise influence on the analog signals affects the unit's ability to output correct position information. The analog cable must be as short as possible and shielded.
- Use the serial converter unit in a location without gases such as H<sub>2</sub>S.
- Do not connect or disconnect the unit while power is being supplied, or the unit may be damaged.
- When using multiple axes, use a shielded cable for each axis. Do not use a shielded cable for multiple axes.
- If you use any linear encoder other than a recommended linear encoder, evaluate the system in advance before you use it.

### 3.6.3 Linear Scale Connection Examples

The following diagrams show connection examples of the linear scale, the SERVOPACK, and the host controller.

#### (1) Incremental Linear Scale

##### ■ Linear Scale Made by Heidenhain

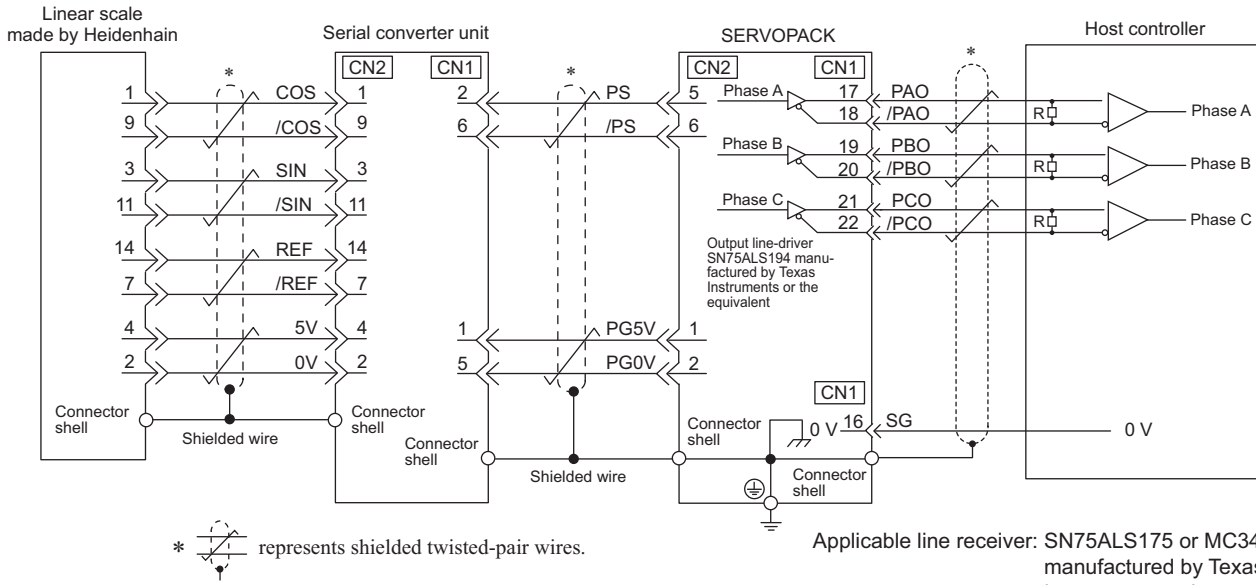

Applicable line receiver: SN75ALS175 or MC3486  
 manufactured by Texas Instruments, or the equivalent  
 R (terminating resistance): 220 to 470 Ω

##### ■ Linear Scale Made by Renishaw plc

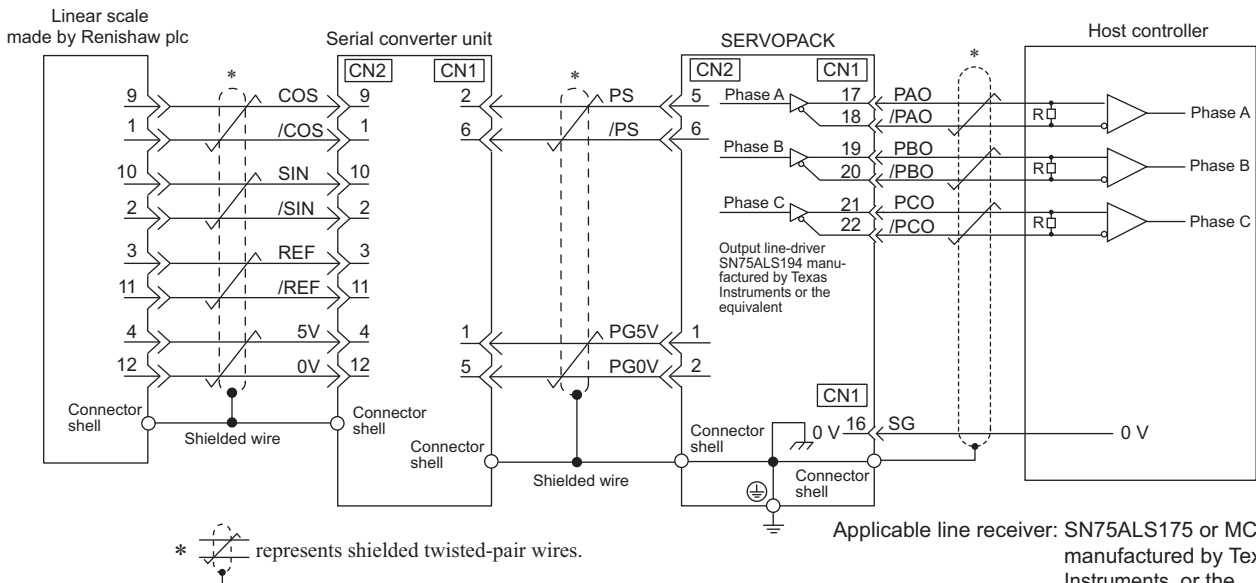

Applicable line receiver: SN75ALS175 or MC3486  
 manufactured by Texas Instruments, or the equivalent  
 R (terminating resistance): 220 to 470 Ω

■ Linear Scale Made by Magnescale Co., Ltd.

- SR75, SR85

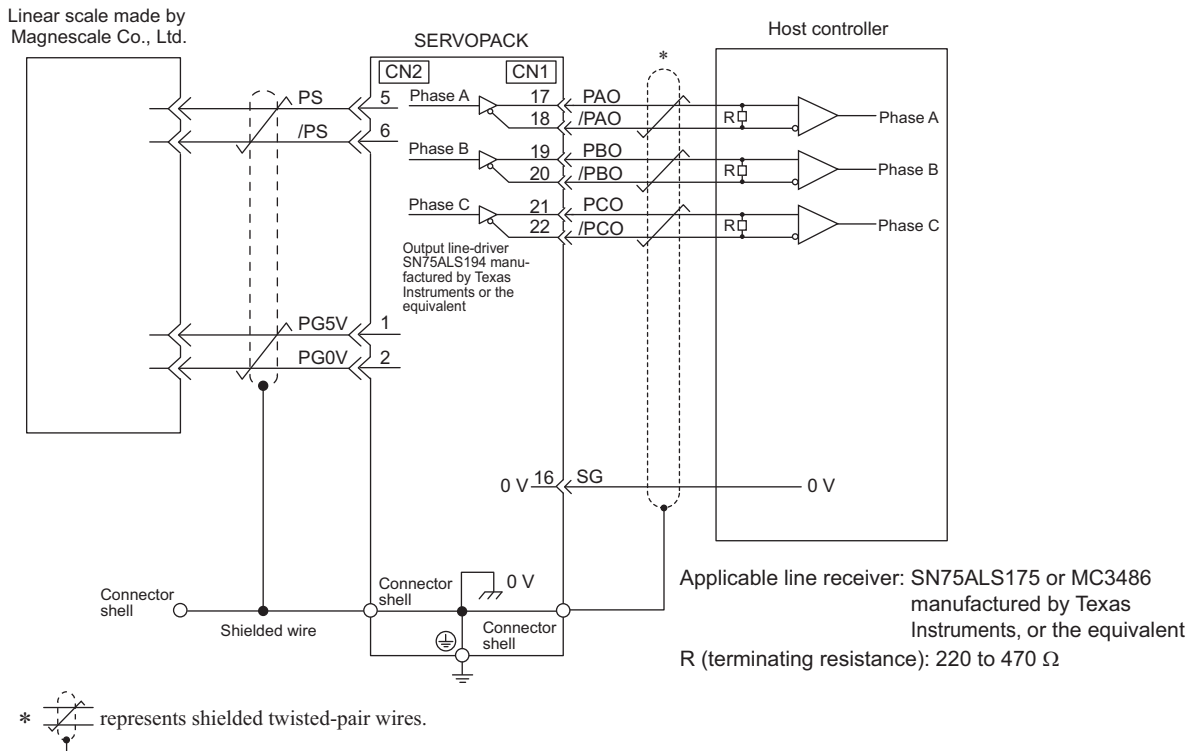

- SL700, SL710, SL720, SL730
- Head with interpolator PL101-RY

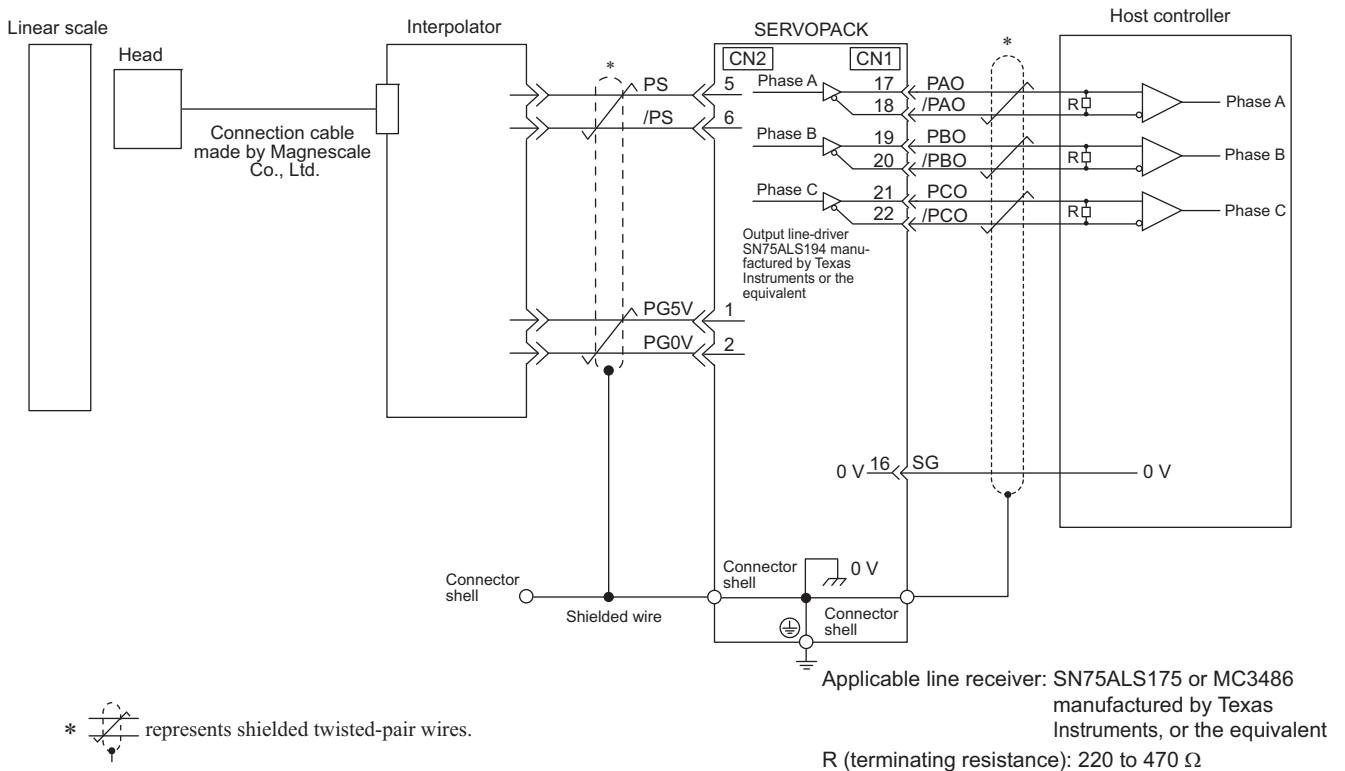

3.6.3 Linear Scale Connection Examples

- SL700, SL710, SL720, SL730
- Interpolator MJ620-T13

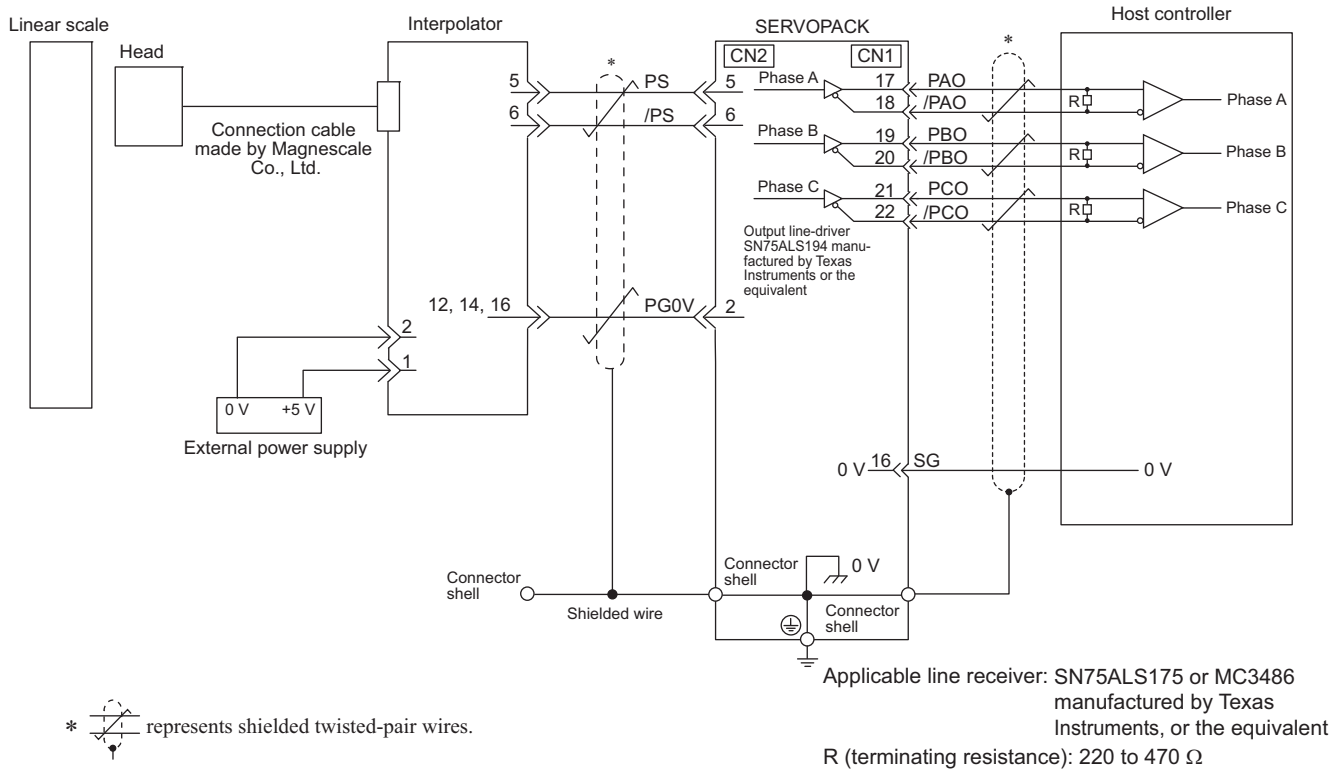

(2) Absolute Linear Scale

■ Linear Scale Made by Heidenhain

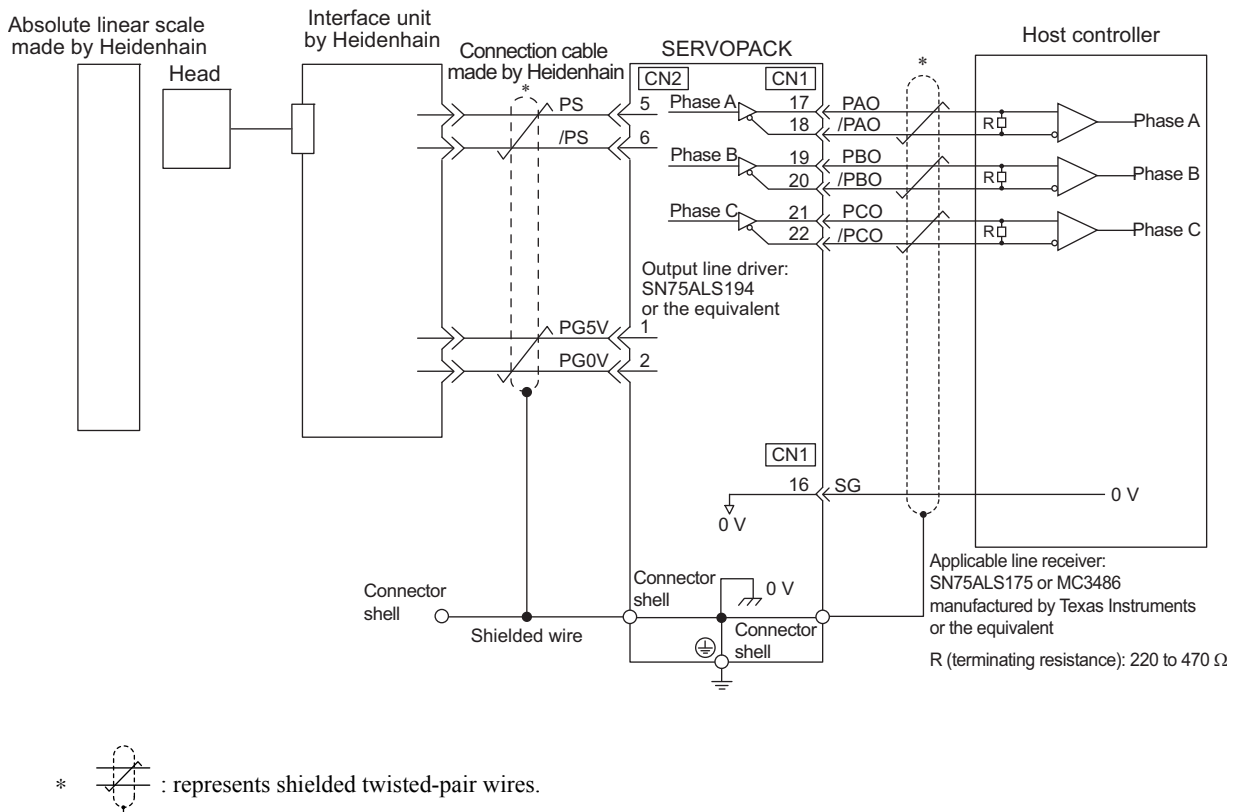

■ Linear Scale Made by Mitutoyo

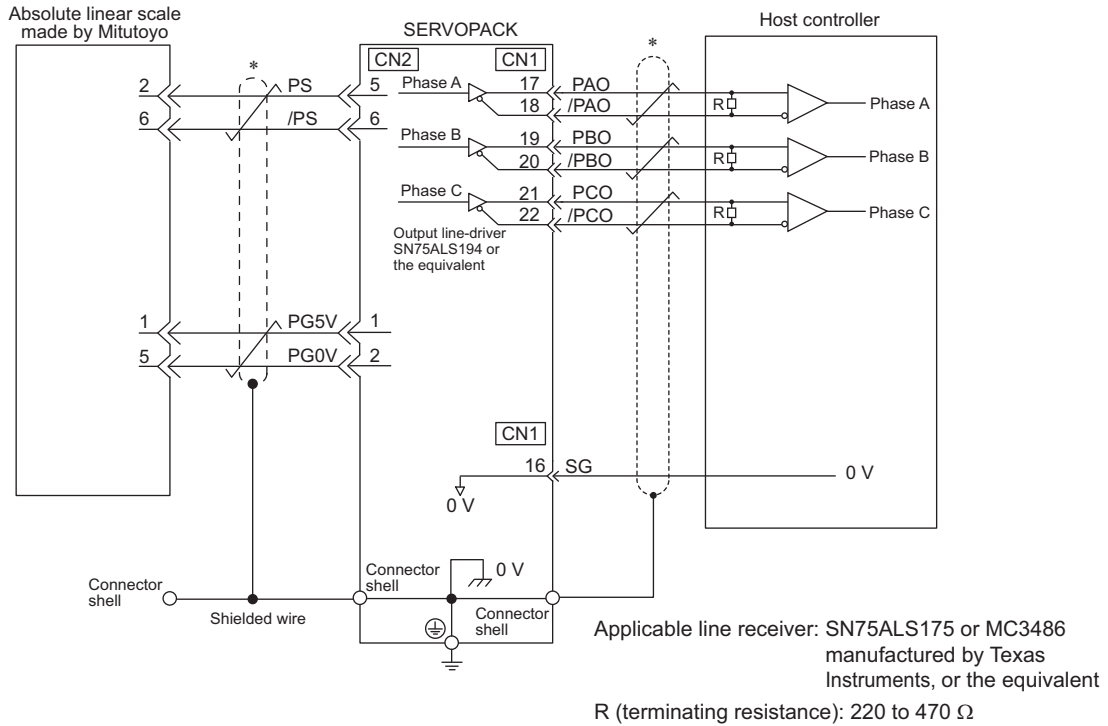

\* : represents shielded twisted-pair wires.

■ Linear Scale Made by Magnescale Co., Ltd.

- SR77, SR87

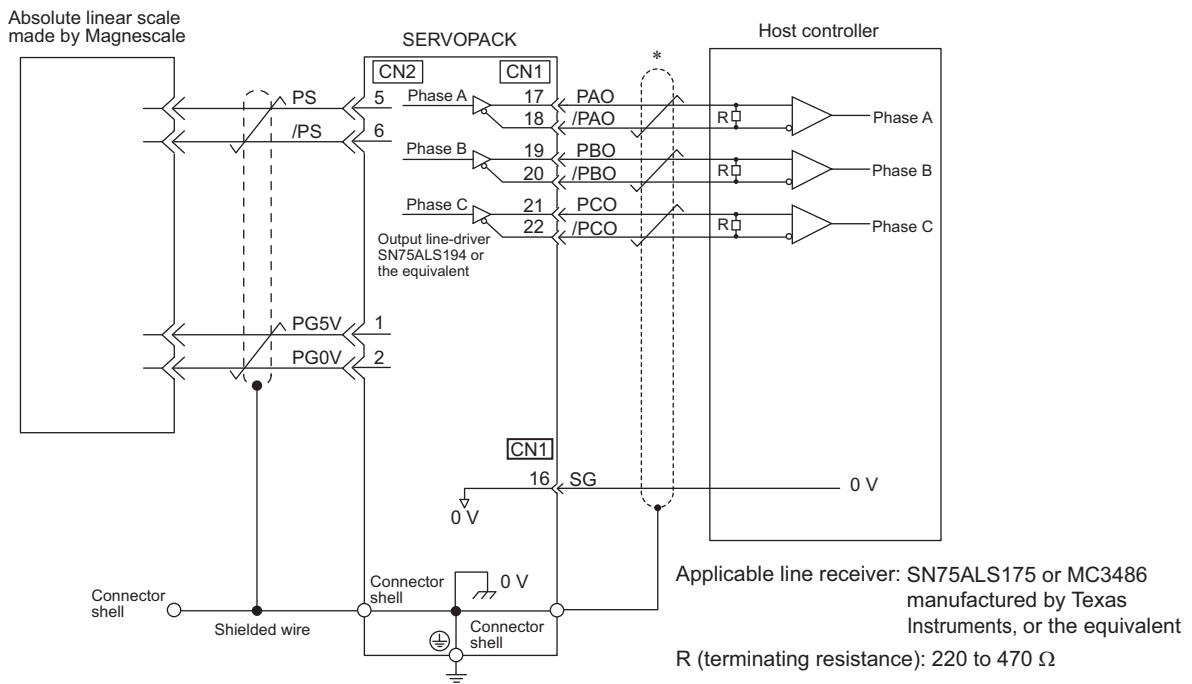

\* : represents shielded twisted-pair wires.

## 3.7 Connecting Regenerative Resistors

If the built-in regenerative resistor is insufficient, connect an external regenerative resistor by one of the following methods and set the regenerative resistor capacity (Pn600). As for precautions on selecting a regenerative resistor and its specifications, refer to *Σ-V Series Product Catalog* (No.: KAEP S800000 42).

### ⚠ WARNING

- Be sure to connect the regenerative resistor correctly. Do not short-circuit between B1/⊕ and B2. Doing so may result in fire or damage to the regenerative resistor or SERVOPACK.

### 3.7.1 Connecting Regenerative Resistors

The following instructions show how to connect the regenerative resistors and SERVOPACKs.

- (1) SERVOPACKs: Model SGD-V-R70F, -R90F, -2R1F, -2R8F, -R70A, -R90A, -1R6A, -2R8A

Connect an external regenerative resistor between the B1/⊕ and B2 terminals on the SERVOPACK. After connecting a resistor, select the capacity. For more information on how to set the capacity of regenerative resistors, refer to 3.7.2 *Setting Regenerative Resistor Capacity*.

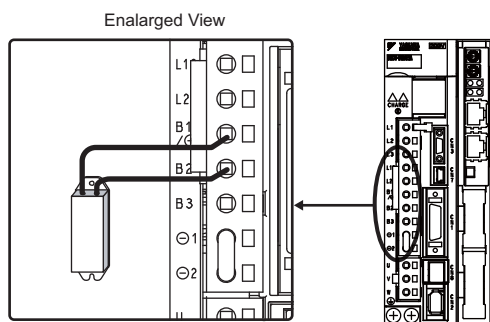

- (2) SERVOPACKs: Model SGD-V-3R8A, -5R5A, -7R6A, -120A, -180A, -200A, -330A, -1R9D, -3R5D, -5R4D, -8R4D, -120D, -170D

Disconnect the wiring between the SERVOPACK's B2 and B3 terminals and connect an external regenerative resistor between the B1/⊕ and B2 terminals. After connecting the resistor, select the capacity. For more information on how to set the capacity of regenerative resistors, refer to 3.7.2 *Setting Regenerative Resistor Capacity*.

Note: Be sure to take out the lead wire between the B2 and B3 terminals.

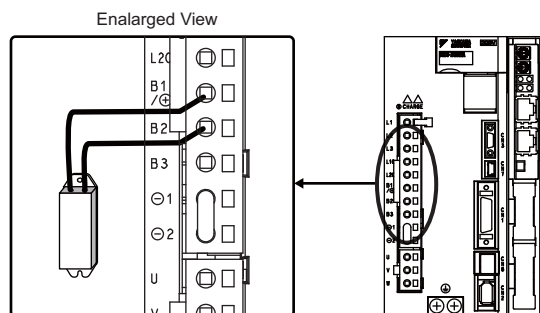

### (3) SERVOPACKs: Model SGDV-550A and -260D

No built-in regenerative resistor is provided, so the external regenerative resistor is required. The regenerative resistor units are as follows:

Note: The regenerative resistor unit is constructed from a number of resistors.

Main Circuit Power Supply	Applicable SERVOPACK Model SGDV-	Applicable Regenerative Resistor Unit	Resistance ( $\Omega$ )	Specifications
Three-phase 200 V	550A	JUSP-RA05-E	3.13	Eight 25 $\Omega$ (220 W) resistors are connected in parallel.
Three-phase 400 V	260D	JUSP-RA18-E	18	Two series of two 18 $\Omega$ (220 W) resistors each are connected in parallel.

Connect the B1/⊕ and B2 terminals of the SERVOPACK to the R1 and R2 terminals of the regenerative resistor unit.

Use Pn600 at the factory setting when you use a Yaskawa regenerative resistor unit. Set Pn600 when using a non-YASKAWA external regenerative resistor.

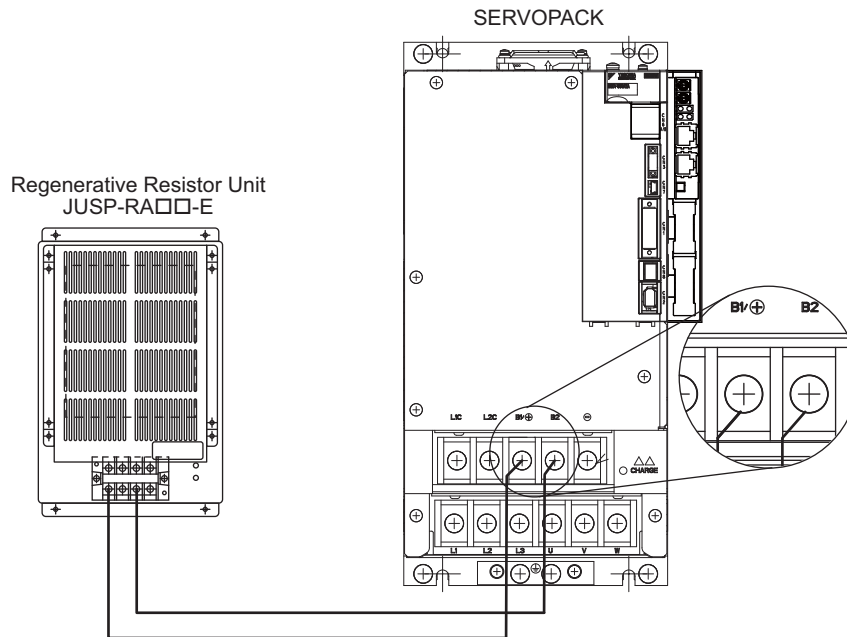

### 3.7.2 Setting Regenerative Resistor Capacity

When a non-Yaskawa external regenerative resistor is connected, always set Pn600 (Regenerative Resistor Capacity) to the resistor capacity.



## WARNING

- If Pn600 is set to 0 when a non-Yaskawa external regenerative resistor is connected, regenerative overload alarms (A.320) may not be detected. If the regenerative overload alarm (A.320) is not detected correctly, the external regenerative resistor may be damaged and an injury or fire may result.

Pn600	Regenerative Resistor Capacity				Classification
	Setting Range	Unit	Factory Setting	When Enabled	
	0 to SERVOPACK capacity	10 W	0	Immediately	

Be sure to set the regenerative resistor capacity (Pn600) to a value that is in accordance with the allowable capacity of the actual external regenerative resistor being used.

- Note 1. If Pn600 is not set to the optimum value, alarm A.320 will occur.
2. When set to the factory setting (Pn600 = 0), the SERVOPACK's built-in resistor or Yaskawa's regenerative resistor unit has been used.

The setting will vary with the cooling method of external regenerative resistor:

- For natural convection cooling: Set the value to a maximum 20% of the actually installed regenerative resistor capacity (W).
- For forced convection cooling: Set the value to a maximum 50% of the actually installed regenerative resistor capacity (W).

Example: Set 20 W (100 W × 20%) for the 100-W external regenerative resistor with natural convection cooling method:

$$\text{Pn600} = 2 \text{ (unit: 10 W)}$$



## IMPORTANT

- When the external regenerative resistors for power are used at the rated load ratio, the resistor temperature increases to between 200 and 300°C. The resistors must be used at or below the rated values. Check with the manufacturer for the resistor's load characteristics.
- For safety, use the external regenerative resistors with thermoswitches.

## 3.8 Noise Control and Measures for Harmonic Suppression

This section describes the wiring for noise control and the DC reactor for harmonic suppression.

### 3.8.1 Wiring for Noise Control



#### IMPORTANT

- Because the SERVOPACK is designed as an industrial device, it provides no mechanism to prevent noise interference.
- The SERVOPACK uses high-speed switching elements in the main circuit. Therefore peripheral devices may receive switching noise. If the equipment is to be used near private houses or if radio interference is a problem, take countermeasures against noise.
- If installation conditions by the EMC directive must be met, refer to *2.5 EMC Installation Conditions in  $\Sigma V$  Series User's Manual Setup Linear Motor* (No.: SIEP S800000 44).

The SERVOPACK uses microprocessors. Therefore it may receive switching noise from peripheral devices.

To prevent the noise from the SERVOPACK or the peripheral devices from causing a malfunction of any one of these devices, take the following precautions against noise as required.

- Position the input reference device and noise filter as close to the SERVOPACK as possible.
- Always install a surge absorber in the relay, solenoid and electromagnetic contactor coils.
- Do not bundle or run the main circuit cables together with the I/O signal cables or the linear scale connection cables in the same duct. Keep the main circuit cables separated from the I/O signal cables and the linear scale connection cables with a gap of at least 30 cm.
- Do not use the same power supply as electric welders, electrical discharge machines, and similar devices. If the SERVOPACK is placed near equipment that generates high-frequency noise, install a noise filter on the input side of the main circuit power supply cable and control power supply cable, even if the same power supply is not used. Refer to *(1) Noise Filter* for the noise filter connection method.
- Take the grounding measures correctly. As for the grounding, refer to *(2) Correct Grounding*.



### 3.8.2 Precautions on Connecting Noise Filter

This section describes the precautions on installing a noise filter.

#### (1) Precautions on Using Noise Filters

Always observe the following installation and wiring instructions.

 <b>IMPORTANT</b>	<p>Some noise filters have large leakage currents. The grounding measures taken also affects the extent of the leakage current. If necessary, select an appropriate leakage current detector or leakage current breaker taking into account the grounding measures that are used and leakage current from the noise filter. Contact the manufacturer of the noise filter for details.</p>
---	---

Do not put the input and output lines in the same duct or bundle them together.

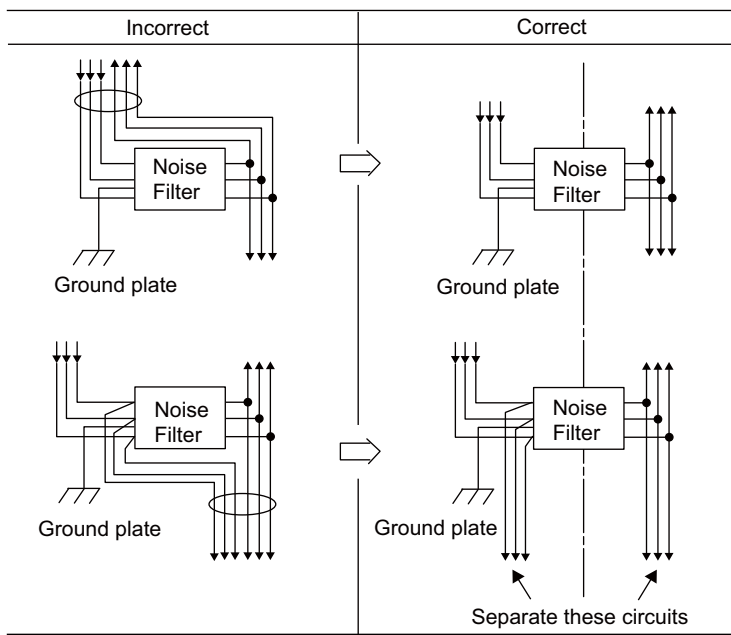

Separate the noise filter ground wire from the output lines.

Do not accommodate the noise filter ground wire, output lines and other signal lines in the same duct or bundle them together.

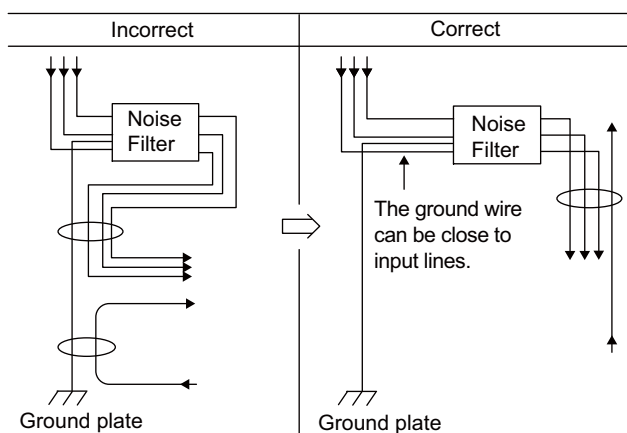

Connect the noise filter ground wire directly to the ground plate.  
Do not connect the noise filter ground wire to other ground wires.

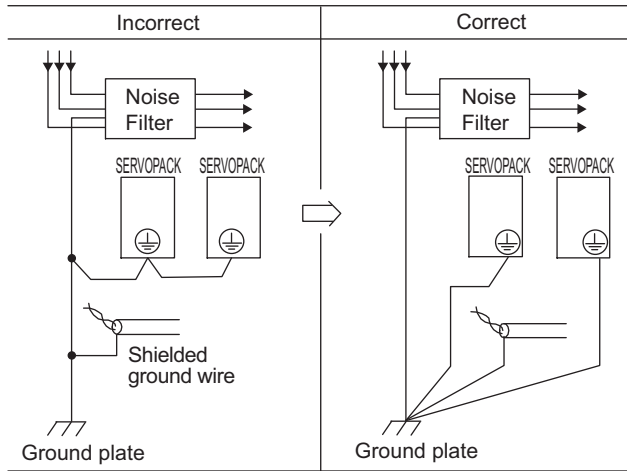

If a noise filter is located inside a control panel, first connect the noise filter ground wire and the ground wires from other devices inside the control panel to the ground plate for the control panel, then ground the plates.

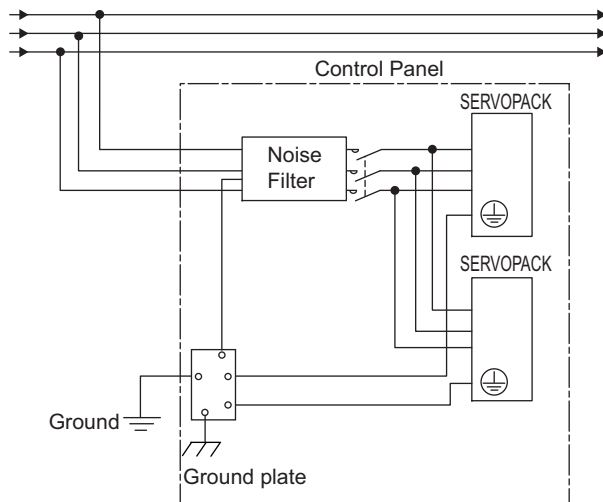

### 3.8.3 Connecting a Reactor for Harmonic Suppression

The SERVOPACK has reactor connection terminals for power supply harmonic suppression that can be used as required. The reactor is an optional part. You must acquire it separately. For reactor selection and specifications, refer to the *Σ-V Series Product Catalog* (Catalog No.: KAEP S800000 42).

Connect a reactor as shown in the following diagram.

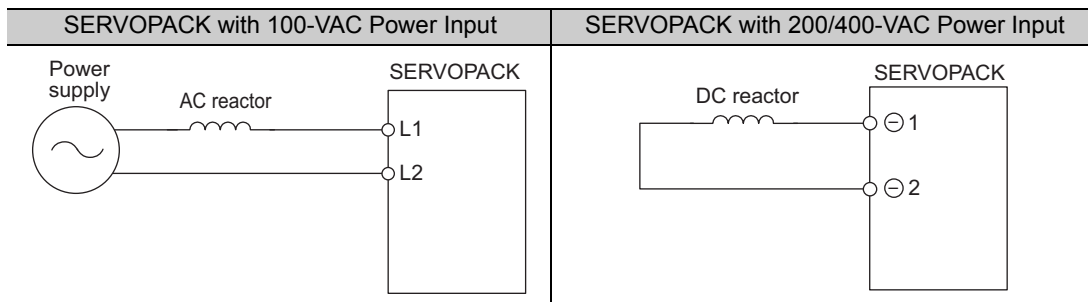

- Note 1. Connection terminals for DC reactor ⊖1 and ⊖2 are short-circuited at shipment. Remove the lead wire for short-circuit, and connect a DC reactor.
- Note 2. DC reactors cannot be connected to SERVOPACKs with a single-phase 100-V power input.

4.1	Option Module Function Settings	4-3
4.2	Settings for Common Basic Functions	4-4
4.2.1	Inspection and Checking before Operation	4-4
4.2.2	Servomotor Movement Direction	4-4
4.2.3	Overtravel	4-6
4.2.4	Electronic Gear	4-9
4.2.4	Electronic Gear	4-9
4.2.5	Encoder Output Pulses	4-12
4.2.6	Setting Encoder Output Pulse	4-18
4.2.7	Holding Brakes	4-19
4.2.8	Stopping Servomotors after Servo OFF Command or Alarm Occurrence	4-23
4.2.9	Instantaneous Power Interruption Settings	4-25
4.2.10	Motor Maximum Speed	4-26
4.2.11	SEMI F47 Function (Force Limit Function for Low DC Power Supply Voltage for Main Circuit)	4-26
4.2.12	Setting Motor Overload Detection Level	4-29
4.3	Test Without Motor Function	4-31
4.3.1	Motor Information	4-31
4.3.2	Motor Position and Speed Responses	4-32
4.3.3	Limitations	4-32
4.3.4	Digital Operator Displays during Testing without Motor	4-33
4.4	Limiting Force	4-34
4.4.1	Internal Force Limit	4-34
4.4.2	External Force Limit	4-35
4.4.3	Checking Output Force Limiting during Operation	4-36
4.5	Absolute Linear Scales	4-37
4.5.1	Absolute Data Request (Sensor ON Command)	4-37
4.5.2	Absolute Data Reception Sequence	4-38

<b>4.6 Other Output Signals</b> .....	<b>4-41</b>
4.6.1 Servo Alarm Output Signal (ALM) .....	4-41
4.6.2 Warning Output Signal (/WARN) .....	4-41
4.6.3 Movement Detection Output Signal (/TGON) .....	4-42
4.6.4 Servo Ready Output Signal (/S-RDY) .....	4-42
4.6.5 Speed Coincidence Output Signal (/V-CMP) .....	4-43
4.6.6 Positioning Completed Output Signal (/COIN) .....	4-44
4.6.7 Positioning Near Output Signal (/NEAR) .....	4-45
4.6.8 Speed Limit Detection Signal (/VLT) .....	4-46
<b>4.7 Safety Function</b> .....	<b>4-48</b>
4.7.1 Hard Wire Base Block (HWBB) Function .....	4-48
4.7.2 External Device Monitor (EDM1) .....	4-53
4.7.3 Application Example of Safety Functions .....	4-55
4.7.4 Confirming Safety Functions .....	4-56
4.7.5 Safety Device Connections .....	4-57
4.7.6 Precautions for Safety Functions .....	4-58

## 4.1 Option Module Function Settings

The DIP switch (SW2) is used to make the settings for option module functions.

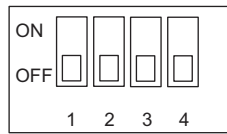

SW2 (factory setting)

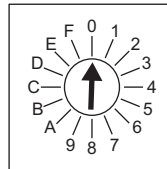

SW1 (factory settings)

For details on the rotary switch (SW1) and the DIP switch (SW2), refer to the manual for the connected command option module.

## 4.2 Settings for Common Basic Functions

This section explains the settings for the common basic functions.

### 4.2.1 Inspection and Checking before Operation

To ensure safe and correct operation, inspect and check the following items before starting operation.

#### (1) Servomotor Status

Inspect and check the following items and take appropriate measures before performing operation if any problem exists.

- Are all wiring and connections correct?
- Are all nuts and bolts securely tightened?

Note: If the servomotor has been stored for a long time before operation, inspect the servomotor according to the maintenance and inspection procedures. For information on maintenance and inspection, refer to *1.8 Servo Drive Maintenance and Inspection*.

#### (2) SERVOPACKS

Inspect and check the following items and take appropriate measures before performing operation if any problem exists.

- Are all wiring and connections correct?
- Is the correct power supply voltage being supplied to the SERVOPACK?

### 4.2.2 Servomotor Movement Direction

The servomotor movement direction can be reversed with parameter Pn000.0 without changing the polarity of the speed/position reference. This causes the movement direction of the servomotor to change, but the polarity of the signal, such as encoder output pulses, output from the SERVOPACK does not change. (refer to 4.2.5)

Before you set this parameter, make sure that the motor phase (Pn080.1) has been set correctly. For the Pn080.1 setting method, refer to the *Σ-V Series User's Manual, Setup, Linear Motor* (No. SIEP S800000 44).

Parameter	Forward/Reverse Reference	Direction of Motor Movement and Encoder Output Pulse	Applicable Overtravel (OT)
<b>Pn000</b>	n.□□□0 The linear scale counts up by a forward reference. [Factory setting]	<p>Forward Reference</p>	P-OT
	Reverse Reference		N-OT
	Forward Reference		P-OT
	Reverse Reference		N-OT

Note: SigmaWin+ trace waveforms are shown in the above table.

### 4.2.3 Overtravel

The overtravel limit function forces movable machine parts to stop if they exceed the allowable range of motion and turn ON a limit switch.

**CAUTION**

- **Installing limit switches**  
For machines that move using linear motion, connect limit switches to P-OT and N-OT of CN1 as shown below to prevent machine damage. To prevent a contact fault or disconnection from causing accidents, make sure that the limit switches are normally closed.

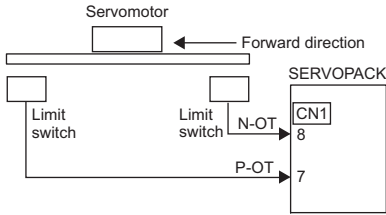

- **Axes to which external force is applied in overtravel**  
Vertical axes:  
There is a risk of the workpiece falling during the overtravel status because the /BK signal will remain ON (brake release). Set the zero clamp status after the servomotor stops (Pn001 = n.□□1□) to prevent the workpiece from falling.  
Other axes to which external force is applied:  
Overtravel will bring about a baseblock state after the servomotor stops, which may cause the servomotor to be pushed back by the load's external force. To prevent this, set the parameter (Pn001 = n.□□1□) to bring the servomotor to zero clamp state after stopping.  
For details on how to set the parameter, refer to (3) *Servomotor Stopping Method When Overtravel is Used*.

#### (1) Signal Setting

Type	Name	Connector Pin Number	Setting	Meaning
Input	P-OT	CN1-7	ON	Forward run allowed. Normal operation status.
			OFF	Forward run prohibited. Forward overtravel.
	N-OT	CN1-8	ON	Reverse run allowed. Normal operation status.
			OFF	Reverse run prohibited. Reverse overtravel.

Movement in the opposite direction is possible during overtravel by inputting the reference.

#### (2) Overtravel Function Setting

Parameters Pn50A and Pn50B can be set to enable or disable the overtravel function.

If the overtravel function is not used, no wiring for overtravel input signals will be required.

Parameter		Meaning	When Enabled	Classification
<b>Pn50A</b>	n.1□□□ [Factory setting]	Inputs the Forward Run Prohibited (P-OT) signal from CN1-7.	After restart	Setup
	n.8□□□	Disables the Forward Run Prohibited (P-OT) signal. Allows constant forward movement.		
<b>Pn50B</b>	n.□□□2 [Factory setting]	Inputs the Reverse Run Prohibited (N-OT) signal from CN1-8.		
	n.□□□8	Disables the Reverse Run Prohibited (N-OT) signal. Allows constant reverse movement.		

A parameter can be used to re-allocate input connector number for the P-OT and N-OT signals. Refer to 3.3.1 *Input Signal Allocations* for details.

### (3) Servomotor Stopping Method When Overtravel is Used

There are three servomotor stopping methods when an overtravel is used.

- Dynamic brake  
By short-circuiting the electric circuits, the servomotor comes to a quick stop.
- Decelerate to a stop  
Stops by using emergency stop force.
- Coast to a stop  
Stops naturally, with no control, by using the friction resistance of the servomotor in operation.

After servomotor stopping, there are two modes.

- Coast mode  
Stopped naturally, with no control, by using the friction resistance of the servomotor in operation.
- Zero clamp mode  
A mode forms a position loop by using the position reference zero.

The servomotor stopping method when an overtravel (P-OT, N-OT) signal is input while the servomotor is operating can be set with parameter Pn001.

Parameter		Stop Method	Mode After Stopping	When Enabled	Classification
Pn001	n.□□00 [Factory setting]	DB	Coast	After restart	Setup
	n.□□01				
	n.□□02	Coast			
	n.□□1□	Deceleration to a stop	Zero clamp		
	n.□□2□		Coast		

- A servomotor under force control cannot be decelerated to a stop. The servomotor is stopped with the dynamic braking (DB) or coasts to a stop according to the setting of Pn001.0. After the servomotor stops, the servomotor will enter a coast state.
- For details on servomotor stopping methods after the servo OFF command is received or an alarm occurs, refer to 4.2.8 *Stopping Servomotors after Servo OFF Command or Alarm Occurrence*.

#### ■ When Servomotor Stopping Method is Set to Decelerate to Stop

Emergency stop force can be set with Pn406.

Pn406	Emergency Stop Force				Classification
	Setting Range	Setting Unit	Factory Setting	When Enabled	
	0 to 800	1%*	800	Immediately	

\* Percentage (%) of rated motor force.

Note: The factory setting is 800% so that the setting is large enough a value to operate the servomotor at maximum force. The maximum value of emergency stop force that is actually available, however, is limited to the maximum force of the servomotor.

#### (4) Overtravel Warning Function

This function detects an overtravel warning (A.9A0) if overtravel occurs while the servomotor power is ON. Using this function enables notifying the host controller when the SERVOPACK detects overtravel even if the overtravel signal is ON only momentarily.

To use this function, set Pn00D to n.1□□□ (Detects overtravel warning).

Note: The overtravel warning function is supported by software version 001A or later. The software version can be checked with Fn012. For details, refer to 6.14 *Software Version Display (Fn012)*.

#### ■ Warning Output Timing

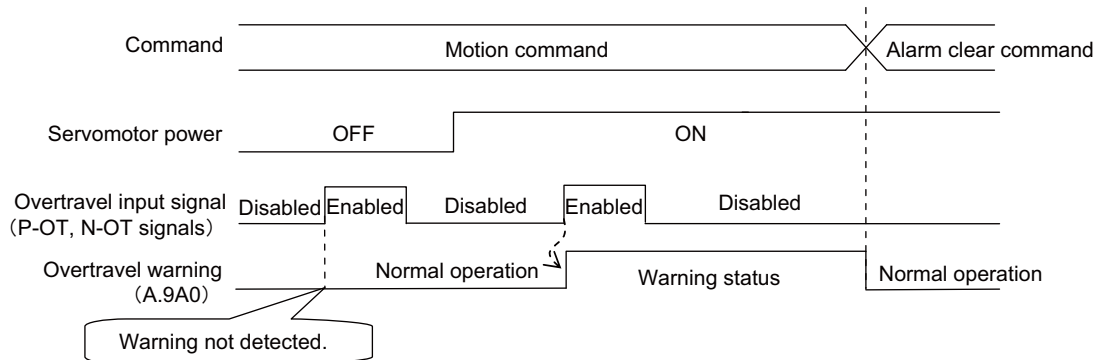

\* For details, refer to the manual for the connected command option module.

<Notes>

- Warnings are detected for overtravel in the same direction as the reference.
- Warnings are not detected for overtravel in the reverse direction from the reference.  
Example: A warning will not be output for a forward reference even if the N-OT signal (reverse run prohibited) turns ON.
- A warning can be detected in either the forward or reverse direction, when there is no reference.
- A warning will not be detected when the servomotor power is OFF even if overtravel occurs.
- A warning will not be detected when the servomotor power changes from OFF to ON even if overtravel status exists.
- The warning can be cleared with the alarm clear command regardless of the servo ON/OFF status or the status of the overtravel signal.
- If the warning is cleared with the alarm clear command during overtravel status, a warning will not be detected again until the overtravel status has been cleared.

### ⚠ CAUTION

- The overtravel warning function only detects warnings. It does not affect on stopping for overtravel or motion operations at the host controller. The next step (e.g., the next motion or other command) can be executed even if an overtravel warning exists. However, depending on the processing specifications and programming for warnings in the host controller, operation may be affected when an overtravel warning occurs (e.g., motion may stop or not stop). Confirm the specifications and programming in the host controller.
- When an overtravel occurs, the SERVOPACK will perform stop processing for overtravel. Therefore, when an overtravel warning occurs, the servomotor may not reach the target position specified by the host controller. Check the feedback position to make sure that the axis is stopped at a safe position.

#### ■ Related Parameter

Parameter	Meaning	When Enabled	Classification
Pn00D	n.0□□□ [Factory setting]	Immediately	Setup
	Does not detect overtravel warning.		
	n.1□□□		
	Detects overtravel warning.		

### 4.2.4 Electronic Gear

The electronic gear enables the workpiece travel distance per reference unit input from the host controller. The minimum unit of the position data moving a load is called a reference unit.

The number of divisions on the serial converter unit: 256

When the Electronic Gear is Not Used

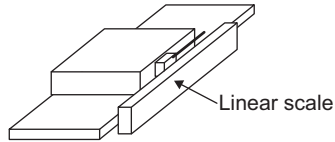

To move a workpiece 10 mm  
 The scale pitch is 20 μm. Therefore,  
 $10 \times 1000 \div 20 \times 256 = 128000$  reference units  
 128000 reference units are input.  
 The equation must be calculated at the host controller.

When the Electronic Gear is Used

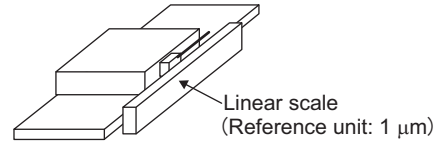

To move a workpiece 10 mm using reference units  
 1 reference unit is 1 μm.  
 To move a workpiece 10 mm (10000 μm),  
 1 reference unit = 1 μm,  
 $10000/1 = 10000$  reference units.  
 Input 10000 reference units as reference input.

#### (1) Electronic Gear Ratio

Set the electronic gear ratio using Pn20E and Pn210.

<b>Pn20E</b>	Electronic Gear Ratio (Numerator) <span style="float: right;">Position</span>				Classification
	Setting Range	Setting Unit	Factory Setting	When Enabled	
	1 to 1073741824	1	4	After restart	Setup
<b>Pn210</b>	Electronic Gear Ratio (Denominator) <span style="float: right;">Position</span>				Classification
	Setting Range	Setting Unit	Factory Setting	When Enabled	
	1 to 1073741824	1	1	After restart	Setup

The electronic gear ratio to be set can be calculated by the following equation:

$$\text{Electronic gear ratio: } \frac{B}{A} = \frac{\text{Pn20E}}{\text{Pn210}} = \frac{\text{Travel distance per reference unit} \times \text{Number of divisions (See following table.)}}{\text{Linear scale pitch}}$$

### ■ Feedback Resolutions of Linear Scale

The linear scale pitches and numbers of divisions are given in the following table.

Calculate the electronic gear ratio using the values in the following table.

Note: Set Pn282 to the linear scale pitch if you use a serial converter unit.

Pn282 is not valid when the linear scale is directly connected to the SERVOPACK and a serial converter unit is not used. Check the linear scale pitch on the Un084 and Un085 monitors.

Type of Linear Scale	Manufacturer	Linear Scale Model	Linear Scale Pitch [μm]	Model of Relay Device between SERVOPACK and Linear Scale	Number of Divisions	Resolution					
Incremental	Heidenhain	LIDA48□	20	JZDP-D003-□□□-E	256	0.078 μm					
				JZDP-G003-□□□-E	4096	0.0049 μm					
		LIF48□	4	JZDP-D003-□□□-E	256	0.016 μm					
				JZDP-G003-□□□-E	4096	0.00098 μm					
	Renishaw plc	RGH22B	20	JZDP-D005-□□□-E	256	0.078 μm					
				JZDP-G005-□□□-E	4096	0.0049 μm					
	Magnescale Co., Ltd.	SR75-□□□□□LF <sup>*1</sup>	80	-	8192	0.0098 μm					
							SR75-□□□□□MF	80	-	1024	0.078 μm
							SR85-□□□□□LF <sup>*1</sup>	80	-	8192	0.0098 μm
							SR85-□□□□□MF	80	-	1024	0.078 μm
		SL700 <sup>*1</sup> , SL710 <sup>*1</sup> , SL720 <sup>*1</sup> , SL730 <sup>*1</sup>	800	PL101-RY MJ620-T13	8192	0.0977 μm					
	Absolute	Heidenhain	LIC4100	20.48	EIB3391Y	4096	0.005 μm				
Mitutoyo Corporation		ST781A/ST781AL	256	-	512	0.5 μm					
		ST782A/ST782AL	256	-	512	0.5 μm					
		ST783/ST783AL	51.2	-	512	0.1 μm					
		ST784/ST784AL	51.2	-	512	0.1 μm					
		ST788A/ST788AL	51.2	-	512	0.1 μm					
		ST789A/ST789AL <sup>*2</sup>	25.6	-	512	0.05 μm					
Magnescale Co., Ltd.		SR77-□□□□□LF <sup>*1</sup>	80	-	8192	0.0098 μm					
		SR77-□□□□□MF	80	-	1024	0.078 μm					
		SR87-□□□□□LF <sup>*1</sup>	80	-	8192	0.0098 μm					
		SR87-□□□□□MF	80	-	1024	0.078 μm					

\*1. When using the encoder pulse output with these linear scales, the setting range of Pn281 is restricted. For details, refer to 4.2.6 *Setting Encoder Output Pulse*.

\*2. For details on this linear scale, contact Mitutoyo.

Refer to the manuals for the linear scale and the serial converter unit for details on the scale pitch and the number of divisions on the linear scale.



**IMPORTANT**

Electronic gear ratio setting range:  $0.001 \leq \text{Electronic gear ratio (B/A)} \leq 4000$

If the electronic gear ratio is outside this range, a parameter setting error 1 (A.040) will be output.

## (2) Electronic Gear Ratio Setting Examples

The following examples show electronic gear ratio settings for different load configurations.

Example: The number on divisions on the serial converter unit: 256

Step	Operation	Load Configuration
1	Check the scale pitch.	0.02 mm (20 $\mu$ m)
2	Determine the reference unit.	1 reference unit: 0.001 mm (1 $\mu$ m)
3	Calculate the electronic gear ratio.	$\frac{B}{A} = \frac{1(\mu\text{m})}{20(\mu\text{m})} \times 256$
4	Set parameters.	Pn20E      256
		Pn210      20

Refer to the following equation to determine the electric gear ratio.

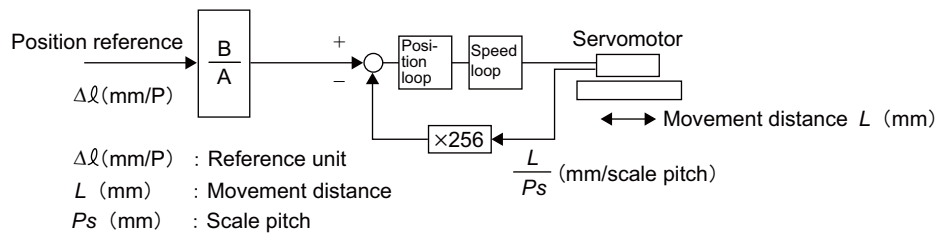

$$\frac{L}{\Delta l} \times \left( \frac{B}{A} \right) = 256 \times \frac{L}{P_s}$$

$$\left( \frac{B}{A} \right) = \frac{256 \times L \times \Delta l}{P_s \times L} = \frac{256 \times \Delta l}{P_s}$$

Set A and B with the following parameters.

$\boxed{A}$  : Pn210     $\boxed{B}$  : Pn20E

### 4.2.5 Encoder Output Pulses

The encoder pulse output is a signal that is output from the linear scale and processed inside the SERVOPACK. It is then output externally in the form of two phase pulse signal (phases A and B) with a 90° phase differential. It is used as the position feedback to the host controller.

Signals and output phase form are as shown below.

(1) Signals

Type	Signal Name	Connector Pin Number	Name	Remarks
Output	PAO	CN1-17	Encoder output pulse: phase A	The resolution of the pulse output from the SERVOPACK to the host controller is set in the parameter for the encoder output resolution (Pn281). Phase A and phase B are different from each other in phase by an electric angle of 90°.
	/PAO	CN1-18		
	PBO	CN1-19	Encoder output pulse: phase B	
	/PBO	CN1-20		
	PCO	CN1-21	Encoder output pulse: phase C*	
	/PCO	CN1-22		

\* For details on the phase C, refer to (3) Encoder Output Pulse Signals from SERVOPACK with a Linear Scale by Renishaw plc.

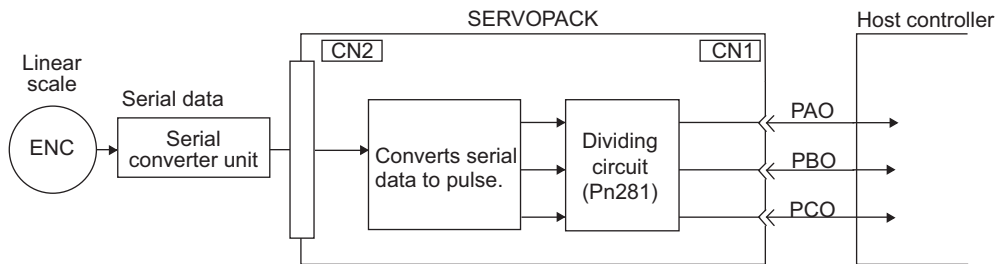

(2) Output Phase Form

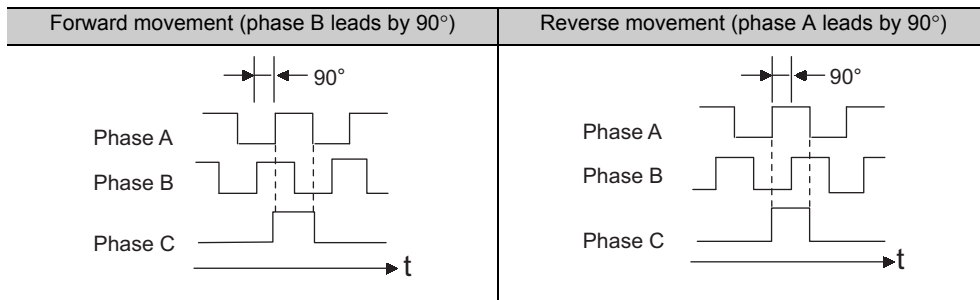

Note: The pulse width for phase C (origin pulse) changes according to the setting of the encoder output resolution (Pn281) and becomes the same as that for phase A.  
 Even in reverse movement mode (Pn000.0 = 1), the output phase form is the same as that for the standard setting (Pn000.0 = 0) above.

### (3) Encoder Output Pulse Signals from SERVOPACK with a Linear Scale by Renishaw plc

The output position of the zero point signal (Ref) will depend on the direction of movement for some models of linear scale by Renishaw plc.

In such case, the phase-C pulses of the SERVOPACK are output at two positions.

For details on the specifications of the zero-point signals for a linear scale, refer to the manual for the Renishaw linear scale.

- Passing First Zero Point Signal (Ref) in Forward Direction and Returning after Power ON

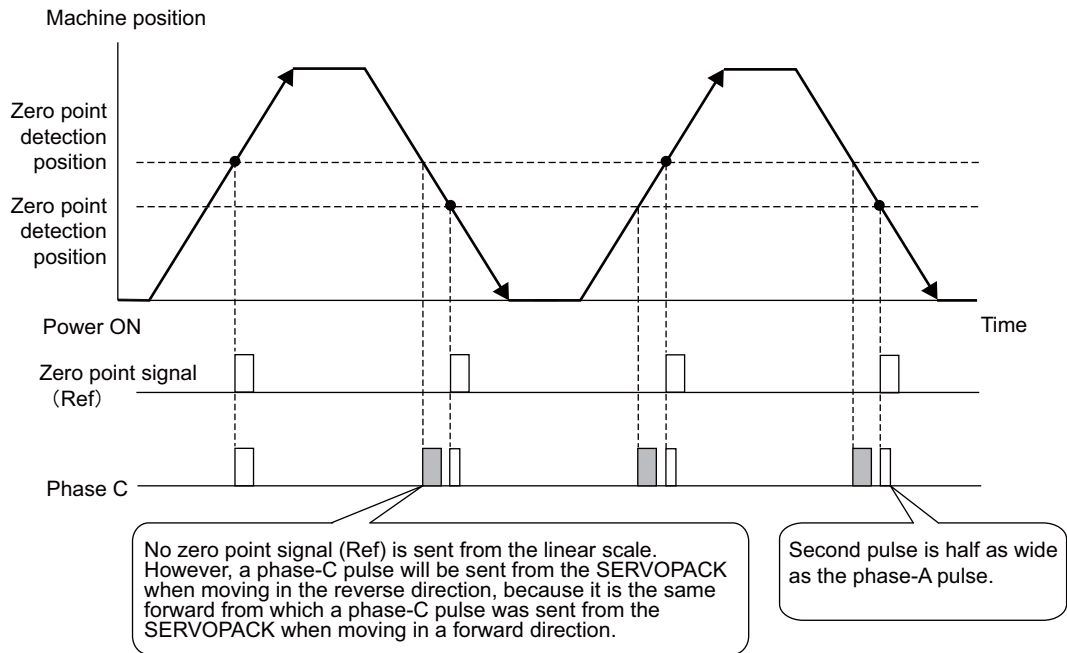

- Passing First Zero Point Signal (Ref) in Reverse Direction and Returning after Power ON

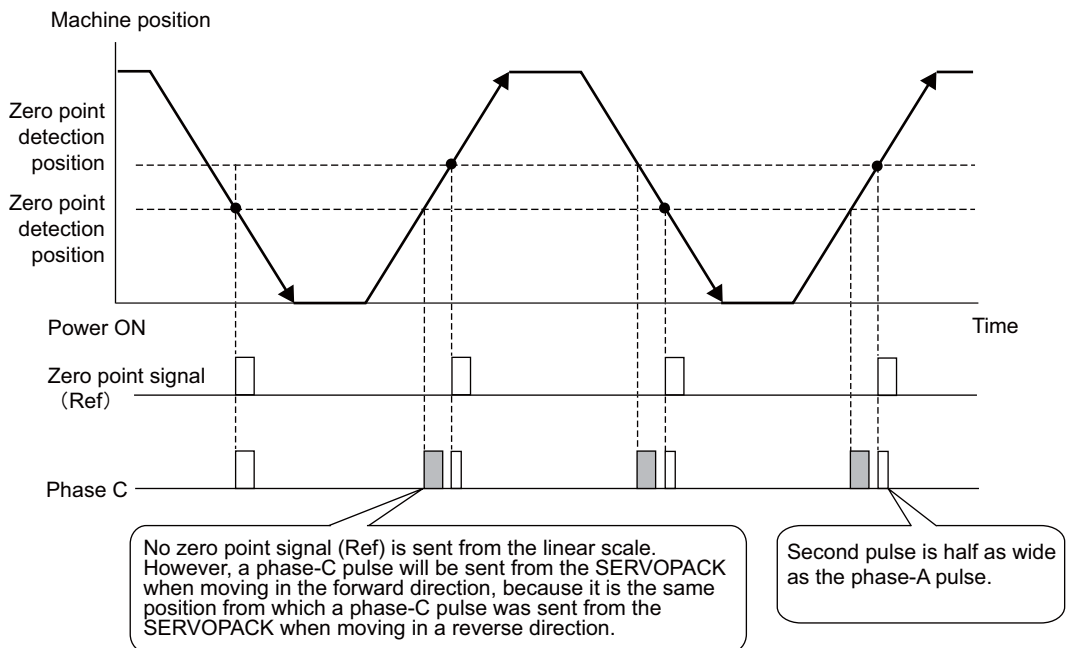

#### (4) Precautions When Using an Incremental Linear Scale by Magnescale

When an incremental linear scale by Magnescale Co., Ltd. is used, the count direction of the linear scale determines if a phase-C pulse (CN1-21, CN1-22) is output and counted.

Note: The count direction (counting up or down) of the linear scale determines if a phase-C pulse is output. The output of the pulse does not depend on the setting of the parameter: Pn000.0 (direction selection).

Model	Interpolator	Scale pitch ( $\mu\text{m}$ )
SL710	PL101-RY MJ620-T13	800
SL720		800
SL730		800
SR75		80
SR85		80

#### ■ Passing First Zero Point in Forward Direction and Returning after Power ON

When the zero point detection position is first passed in the forward direction after turning the power supply OFF and ON again, the encoder dividing phase-C pulse (CN1-21 and CN1-22) is output. Then the encoder dividing phase-C pulse is output when the zero point detection position is passed in either the forward or reverse direction.

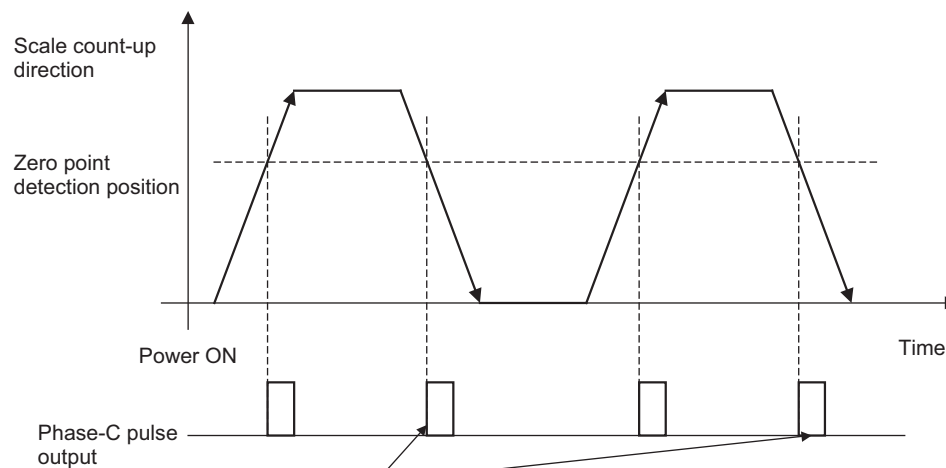

The phase-C pulse is also output when the detection head of the linear scale passes this point in reverse, because the SERVOPACK has recorded the position where the phase-C pulse was originally output when first passing the position in the forward direction.

### ■ Passing First Zero Point in Reverse Direction and Returning after Power ON

When the zero point detection position is first passed in the reverse direction after turning the power supply OFF and ON again, the encoder dividing phase-C pulse (CN1-21 and CN1-22) is not output. However, after the zero point detection position is passed in the forward direction and the encoder dividing phase-C pulse is output, the encoder dividing phase-C pulse is output even when the zero point detection position is passed in the reverse direction.

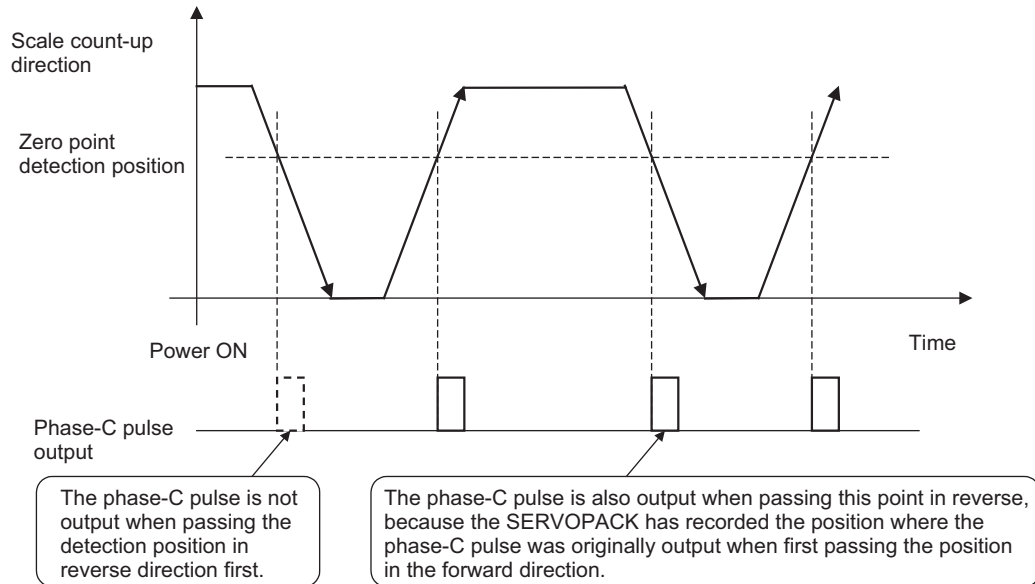

### ■ Linear Scale with Multiple Zero Points and Passing First Zero Point in Forward Direction and Returning after Power ON

When you use a linear scale with multiple zero points, each zero point operates in the same manner as 4.2.5 (4) ■ *Passing First Zero Point in Reverse Direction and Returning after Power ON.*

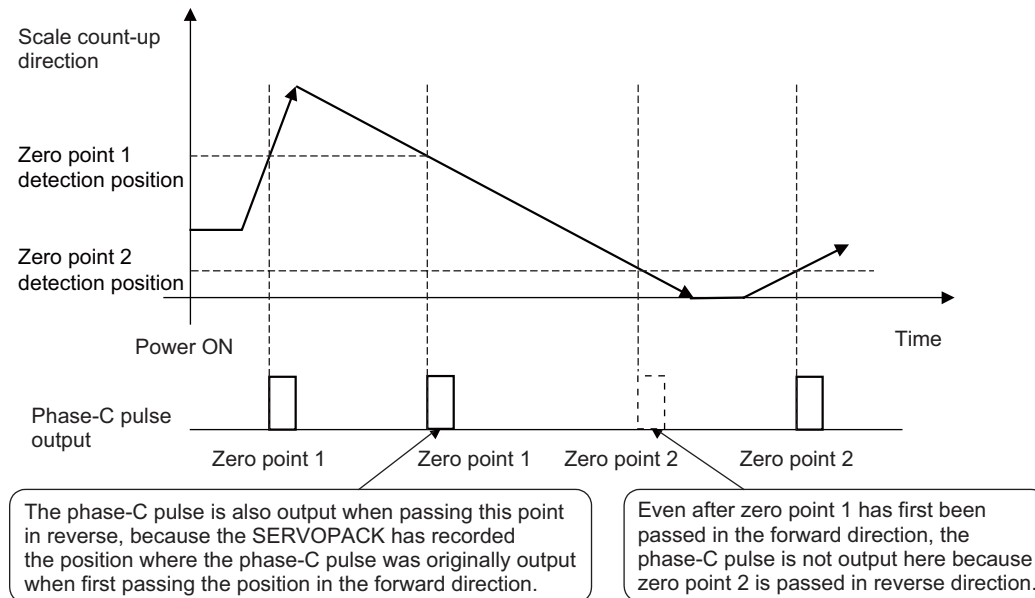

■ Linear Scale with Multiple Zero Points and Passing First Zero Point in Reverse Direction after Power ON

When you use a linear scale with multiple zero points, each zero point operates in the same manner as 4.2.5 (4) ■ *Passing First Zero Point in Reverse Direction and Returning after Power ON.*

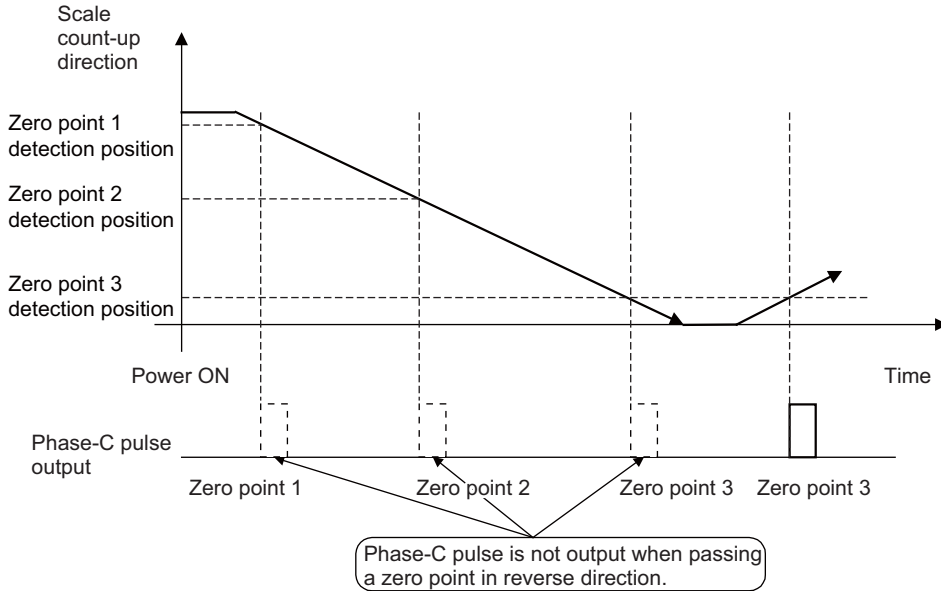

To output the encoder dividing phase-C pulse when moving in the reverse direction, set Pn081 to n.□□□1.

Parameter	Meaning	When Enabled	Classification
<b>Pn081</b>	n.□□□0 [Factory Setting]	Outputs phase-C pulse only in forward direction.	After restart Setup
	n.□□□1	Outputs phase-C pulse in forward and reverse direction.	

Note: Software version 0023 or higher is required to use this parameter.

<NOTE>

The encoder output pulse is output in the forward and reverse directions regardless of the setting of Pn081 when a serial converter unit is used.



### IMPORTANT

#### ■ Setting of Pn081.0

Do not change the factory setting if the zero point position of the existing equipment must remain as is.

- When Pn081 is set to n.□□□1, the encoder dividing phase-C pulse output width may be narrower than the width of the phase-A pulse.
- As shown in the following diagram, there is a 1/8th scale pitch difference in the encoder dividing phase-C pulse output position and the phase-C detection position with the phase-C latch when Pn081 is set to n.□□□0 and when Pn081 is set to n.□□□1.

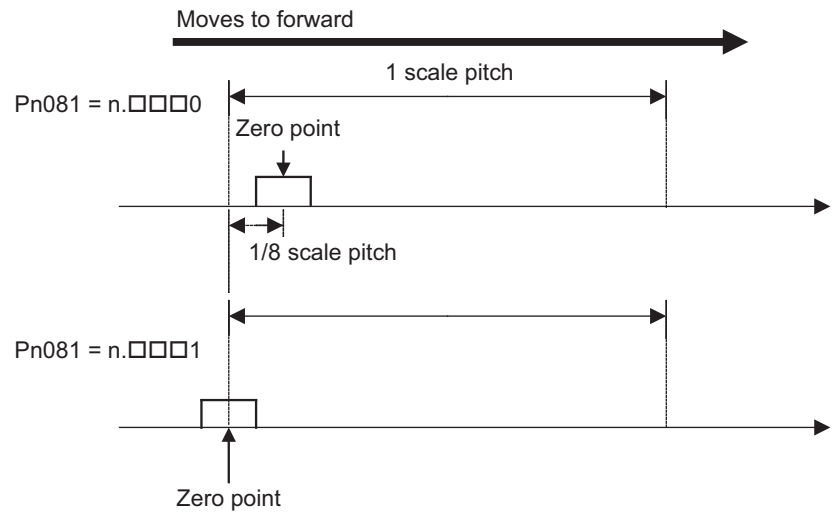

## 4.2.6 Setting Encoder Output Pulse

Set the encoder output pulse using the following parameter.

<b>Pn281</b>	Encoder Output Resolution <span style="float: right;">Speed   Position   Force</span>				Classification
	Setting Range	Setting Unit	Factory Setting	When Enabled	
	1 to 4096	1 edge/pitch	20	After restart	Setup

Note: The maximum setting for the encoder output resolution is 4096. When the number of divisions on the linear scale is more than 4096, the data shown in 4.2.4 (1) ■ *Feedback Resolutions of Linear Scale* is no longer applicable.

Set the encoder output resolution for encoder pulse output signals (PAO, /PAO, PBO, /PBO) from the SERVOPACK to the host controller.

Feedback pulses per linear scale pitch\* are divided inside the SERVOPACK by the value set in Pn281 (value after multiplication by 4) before being output. (Adjust the settings to the system specifications of the machine or host controller.)

The setting range depends on the servomotor's maximum speed (Pn385) and linear scale pitch\*. The upper limit for Pn281 can be calculated with the following formula.

$$\text{Upper limit value for Pn281} = \frac{\text{Linear scale pitch}^*/100}{\text{Pn385}} \times 72$$

\* The value depends on whether or not a serial converter unit is used.

Using a serial converter unit	Value of Pn282
Not using a serial converter unit. (When the linear scale and SERVOPACK are directly connected and when a linear scale that does not require a serial converter unit is used)	Value in the table in 4.2.4 (1) ■ <i>Feedback Resolutions of Linear Scale</i> . In this case, the set value in Pn282 is ignored because the SERVOPACK automatically recognizes the linear scale pitch. The value of the automatically recognized linear scale pitch can be checked with Un084 and Un085.

Note: When the scale pitch is 4 μm, the motor maximum speed is limited to 1 m/s because of the maximum response frequency of serial converter unit.

If the set value is out of the setting range or does not satisfy the setting conditions, the alarm "Encoder Output Pulse Setting Error" (A.041) is output.

If the motor speed exceeds the upper limit value according to the set encoder output resolution, the alarm "Over-speed of Encoder Output Pulse Rate" (A.511) is output.

The upper limit of encoder output resolution is limited by the frequency dividing specification of serial converter unit.

### ■ Setting Example

When the linear scale pitch = 20 μm and the motor maximum speed = 5 m/s (Pn385 = 50):  
Pn281 = 28 is accepted, but Pn281 = 29 is not accepted and A.041 is output.

### ■ Output Example

When Pn281 = 20 (20-edge output (5-pulse output) per linear scale pitch),

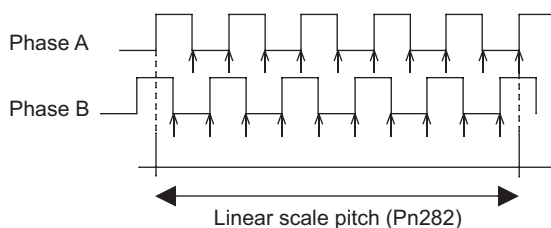

## 4.2.7 Holding Brakes

A holding brake is a brake used to hold the position of the movable part of the machine when the SERVO-PACK is turned OFF so that movable part does not move due to gravity or external forces. The brake is not included, so if necessary, install a holding brake on the machine.

The brake has the following operation delay times:

- Brake release time: The time from when the brake (/BK) signal is turned ON to when the brake actually releases.
- Brake operation time: The time from when the brake (/BK) signal is turned OFF to when the brake is actually applied.

Set the operation ON and OFF timing as shown below while taking into consideration the brake operation delay times.

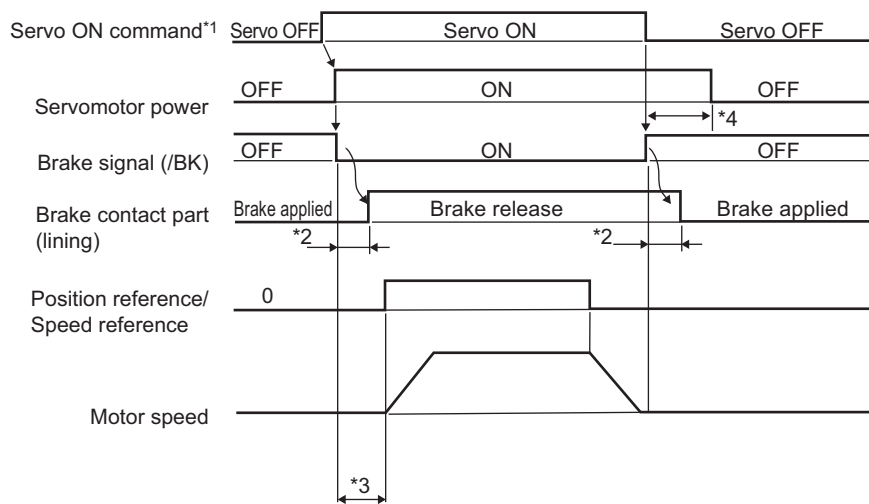

- \*1. For details, refer to the manual for the connected command option module.
- \*2. The brake operation delay times depend on the model of brake that you use. Set the parameters related to the brake signal (/BK) output timing according to the operation delay times for your brake.
- \*3. After the servo ON command is turned ON, wait at least for the brake release time plus 50 ms, and then output the reference from the host controller to the SERVOPACK.
- \*4. Set the brake operation and servo OFF timing with Pn506, Pn508, and Pn583.

### (1) Wiring Example

Use the brake signal (/BK) and the brake power supply to form a brake ON/OFF circuit. The following diagram shows a standard wiring example.

The timing can be easily set using the brake signal (/BK).

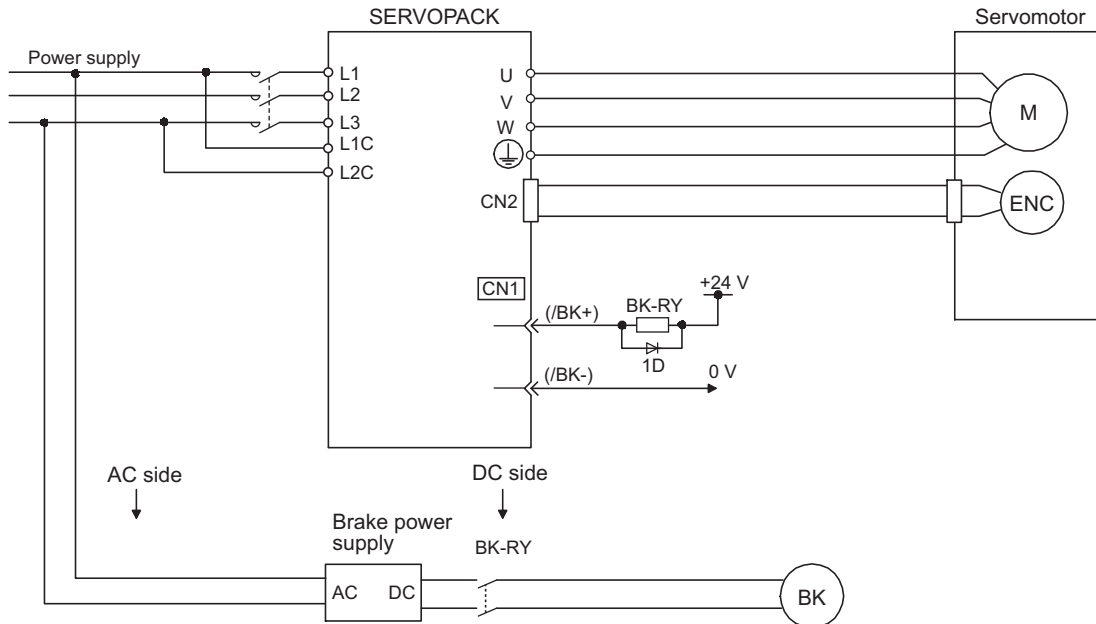

Note: A brake and its power supply are not included.



**IMPORTANT**

- Configure the relay circuit to apply the holding brake by the emergency stop.

**Relay Circuit Example**

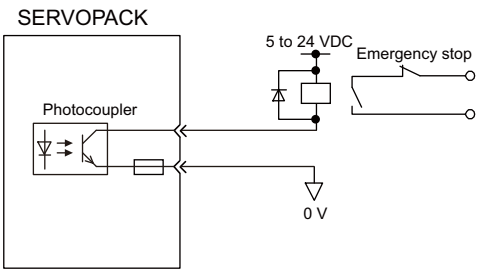

- The allocation of the /BK signal can be changed. Refer to (3) *Brake Signal (/BK) Allocation* to set the parameter Pn50F.
- When using a 24-V brake, separate the 24-VDC power supply from other power supplies, such as the one used for the I/O signals of CN1 connectors. Always install the 24-VDC power supply separately. If the power supply is shared, the I/O signals might malfunction.

## (2) Brake Signal (/BK) Setting

This output signal controls the brake. The allocation of the /BK signal can be changed. For details, refer to (3) *Brake Signal (/BK) Allocation*.

The /BK signal turns OFF (applies the brake) when an alarm is detected or the servo OFF command is received. The brake OFF timing can be adjusted with Pn506.

Type	Name	Connector Pin Number	Setting	Meaning
Output	/BK	CN1-1, CN1-2	ON (closed)	Releases the brake.
			OFF (open)	Applies the brake.



The /BK signal is still ON during overtravel and the brake is still released.

IMPORTANT

## (3) Brake Signal (/BK) Allocation

Use parameter Pn50F.2 to allocate the /BK signal.

Parameter	Connector Pin Number		Meaning	When Enabled	Classification	
	+ Terminal	- Terminal				
Pn50F	n.□0□□	–	–	The /BK signal is not used.	After restart	Setup
	n.□1□□ [Factory setting]	CN1-1	CN1-2	The /BK signal is output from output terminal CN1-1, 2.		
	n.□2□□	CN1-23	CN1-24	The /BK signal is output from output terminal CN1-23, 24.		
	n.□3□□	CN1-25	CN1-26	The /BK signal is output from output terminal CN1-25, 26.		



When multiple signals are allocated to the same output terminal, the signals are output with OR logic. For the /BK signal, do not use the output terminal that is already being used for another signal.

IMPORTANT

## (4) Brake ON Timing after the Servomotor Stops

When the servomotor stops, the /BK signal turns OFF at the same time as the servo ON command turns OFF. Use parameter Pn506 to change the timing to turn OFF the servomotor power after the servo ON command is turned OFF.

Pn506	Brake Reference-Servo OFF Delay Time				Classification
	Setting Range	Setting Unit	Factory Setting	When Enabled	
	0 to 50	10 ms	0	Immediately	Setup

- When using the servomotor to control a vertical axis, the machine movable part may shift slightly depending on the brake ON timing due to gravity or an external force. To eliminate this slight shift, set parameter so that the power to the servomotor turns OFF after the brake is applied.
- This parameter changes the brake ON timing while the servomotor is stopped.

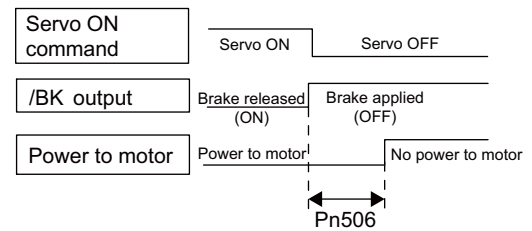



**IMPORTANT**

The servomotor will turn OFF immediately when an alarm occurs, regardless of the setting of this parameter. The machine movable part may shift due to gravity or external force before the brake operates.

### (5) Brake Signal (/BK) Output Timing during Servomotor Movement

If an alarm occurs while the servomotor is moving, the servomotor will come to a stop and the brake signal (/BK) will be turned OFF. The timing of brake signal (/BK) output can be adjusted by setting the brake reference output speed level (Pn583) and the waiting time for brake signal when motor running (Pn508).

Note: If the stopping method when an alarm occurs is set to a zero-speed stop, the operation described in (4) *Brake ON Timing after the Servomotor Stops* is performed after the servomotor stops.

<b>Pn583</b>	Brake Reference Output Speed Level <span style="float: right;">Speed <input type="checkbox"/> Position <input type="checkbox"/> Force <input type="checkbox"/></span>				Classification
	Setting Range	Setting Unit	Factory Setting	When Enabled	
	0 to 10000	1 mm/s	10	Immediately	
<b>Pn508</b>	Waiting Time for Brake Signal When Motor Running <span style="float: right;">Speed <input type="checkbox"/> Position <input type="checkbox"/> Force <input type="checkbox"/></span>				Classification
	Setting Range	Setting Unit	Factory Setting	When Enabled	
	10 to 100	10 ms	50	Immediately	

#### /BK Signal Output Conditions When Servomotor Moving

The /BK signal goes to high level (brake ON) when either of the following conditions is satisfied:

- When the motor speed falls below the level set in Pn583 after the power to the servomotor is turned OFF.
- When the time set in Pn508 is exceeded after the power to the servomotor is turned OFF.

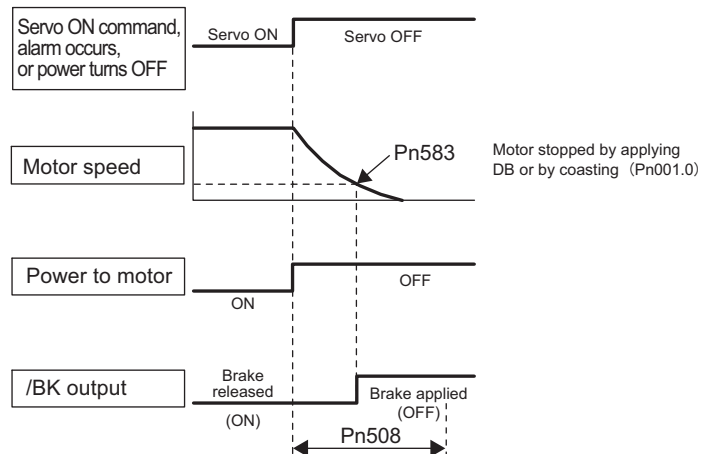



**IMPORTANT**

- The servomotor will be limited to its maximum speed even if the value set in Pn583 is higher than the maximum speed.
- Do not allocate the movement detection signal (/TGON) and the brake signal (/BK) to the same terminal. The /TGON signal will otherwise be turned ON by the falling speed on a vertical axis, and the brake may not operate. For the /BK signal, do not use the terminal that is already being used for another signal.

### 4.2.8 Stopping Servomotors after Servo OFF Command or Alarm Occurrence

The servomotor stopping method can be selected after the servo OFF command is received or an alarm occurs.



#### IMPORTANT

- Dynamic braking (DB) is used for emergency stops. The DB circuit will operate frequently if the power is turned ON and OFF or the servo ON command is received with a reference input applied to start and stop the servomotor, which may result in deterioration of the internal elements in the SERVOPACK.  
Use speed input references or position references to start and stop the servomotor.
- If the main circuit power supply or the control power supply is turned OFF but the servo OFF command has not been received, the stopping method for servomotor cannot be set in the parameters. Use the following method to stop the servomotor.  
If turning OFF the main circuit power supply, but the servo OFF command has not been received, the servomotor will be stopped by dynamic braking.  
If turning OFF the control power supply, but the servo OFF command has not been received, the stopping method will vary with the SERVOPACK model. Two stopping methods are available.
  - SERVOPACK models for servomotors that stop by coasting:  
SGDV-330A and -550A
  - SERVOPACK models for servomotors that stops by dynamic braking:  
All SERVOPACKs other than those listed for coasting.
- If a coasting stop without decelerating is required when the main circuit power supply is turned OFF or the control power supply is turned OFF during operation without turning OFF the servo, use a SERVOPACK without a dynamic brake (SERVOPACK model digits 8 through 10 are 020).
- To minimize the coasting distance of the servomotor to come to a stop when an alarm occurs, the zero-speed stopping method is factory-set for alarms to which the zero-speed stop method is applicable. The DB stopping method may be more suitable than the zero-speed stopping method, however, depending on the application.  
For example, for multiple axes coupling operation (a twin-drive operation), machinery damage may result if a zero-speed stop alarm occurs for one of the coupled shafts and the other shaft stops by dynamic brake. In such cases, change the method to the DB stopping method.

#### (1) Stopping Method for Servomotor after Servo OFF Command is Received

Use Pn001.0 to select the stopping method for the servomotor after the servo OFF command is received.

	Parameter	Stop Mode	Mode After Stopping	When Enabled	Classification
Pn001	n.□□□0 [Factory setting]	DB	DB	After restart	Setup
	n.□□□1		Coast		
	n.□□□2	Coast	Coast		

Note: Similar to the Coast Mode, the n.□□□0 setting (which stops the servomotor by dynamic braking and then holds it in Dynamic Brake Mode) does not generate any braking force when the servomotor stops or when it moves at very low speed.

## (2) Stopping Method for Servomotor When an Alarm Occurs

There are two types of alarms (Gr.1 and Gr.2) that depend on the stopping method when an alarm occurs. Select the stopping method for the servomotor when an alarm occurs using Pn001.0 and Pn00B.1.

The stopping method for the servomotor for a Gr.1 alarm is set to Pn001.0.

The stopping method for the servomotor for a Gr.2 alarm is set to Pn00B.1.

Refer to the information on alarm stopping methods in 8.1.1 *List of Alarms*.

### ■ Stopping Method for Servomotor for Gr.1 Alarms

The stopping method of the servomotor when a Gr.1 alarm occurs is the same as that in (1) *Stopping Method for Servomotor after Servo OFF Command is Received*.

Parameter		Stop Mode	Mode After Stopping	When Enabled	Classification
<b>Pn001</b>	n.□□□0 [Factory setting]	DB	DB	After restart	Setup
	n.□□□1		Coast		
	n.□□□2	Coast	Coast		

### ■ Stopping Method for Servomotor for Gr.2 Alarms

Parameter		Stop Mode	Mode After Stopping	When Enabled	Classification
Pn00B	Pn001				
n.□□0□ [Factory setting]	n.□□□0 [Factory setting]	Zero-speed stop- ping	DB	After restart	Setup
	n.□□□1		Coast		
	n.□□□2				
n.□□1□	n.□□□0 [Factory setting]	DB	DB		
	n.□□□1		Coast		
	n.□□□2	Coast			

Note: The setting of Pn00B.1 is effective for position control and speed control. Pn00B.1 will be ignored for force control and only the setting of Pn001.0 will be valid.

### 4.2.9 Instantaneous Power Interruption Settings

Determines whether to continue operation or turn OFF the servomotor's power when the power supply voltage to the SERVOPACK's main circuit is interrupted.

Pn509	Instantaneous Power Cut Hold Time				Classification
	Setting Range	Setting Unit	Factory Setting	When Enabled	
	20 to 1000	1 ms	20	Immediately	Setup

If the instantaneous power interruption time is equal to or lower than the set value in Pn509, the servomotor will continue to be powered. If the instantaneous power interruption time exceeds the set value in Pn509, the servomotor is not powered. The servomotor is turned ON when power supply to the main circuit recovers.

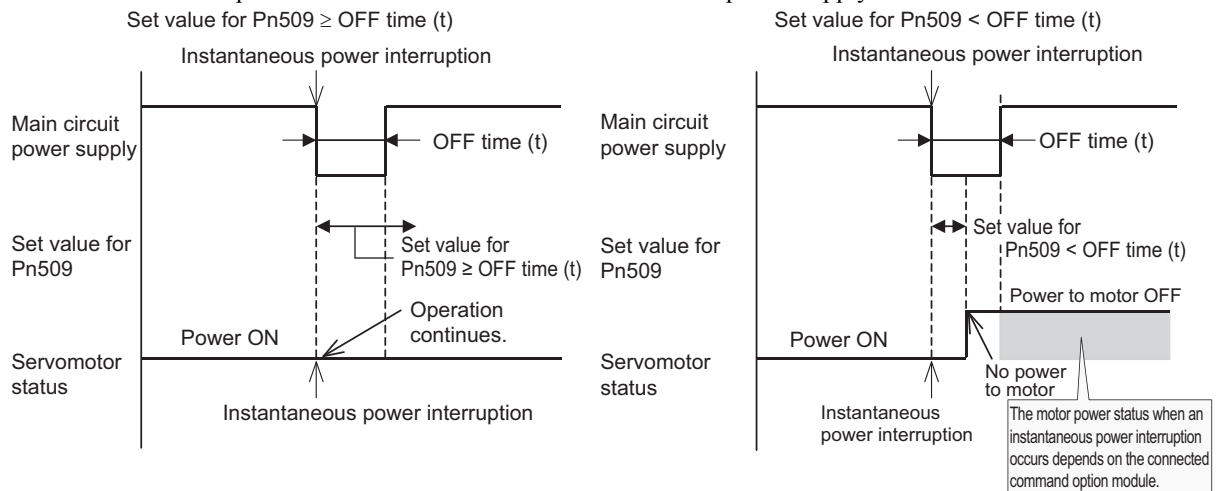

#### <NOTE>

If the instantaneous power interruption time exceeds the set value in Pn509, the /S-RDY signal will be turned OFF.



**IMPORTANT**

- The holding time of the control power supply for the 200-V SERVOPACKs is approximately 100 ms. The holding time of the control power supply for the 100-V SERVOPACKs is approximately 65 ms. If the control power supply makes control impossible during an instantaneous power interruption, the same operation will be performed as for normally turning OFF the power supply, and the setting of Pn509 will be ignored.
- The holding time of the main circuit power supply varies with the output of the SERVOPACK. If the load on the servomotor is large and an undervoltage alarm (A.410) occurs, the setting of Pn509 will be ignored.
- The holding time of the control power supply (24 VDC) for the 400-V SERVOPACKs depends on the capability of the power supply (not included). Check the power supply before using the application.

If the uninterruptible power supplies are used for the control power supply and main circuit power supply, the SERVOPACK can withstand an instantaneous power interruption period in excess of 1000 ms.

## 4.2.10 Motor Maximum Speed

By setting a lower speed, the following effects can be obtained.

- More delicate speed control and more strict protection by generating the overspeed alarm (A.510)
- Allows the upper limit of Encoder Output Resolution (Pn281) to be set higher.  
For details, refer to 4.2.5 *Encoder Output Pulses*.

Pn385	Motor Maximum Speed				Classification
	Setting Range	Setting Unit	Factory Setting	When Enabled	
	1 to 100	100 mm/s	50	After restart	

## 4.2.11 SEMI F47 Function (Force Limit Function for Low DC Power Supply Voltage for Main Circuit)

The force limit function detects an undervoltage warning and limits the output current if the DC power supply voltage for the main circuit in the SERVOPACK drops to a specified value because the power was momentarily interrupted or the power supply voltage for the main circuit was temporarily lowered.

This function complies with SEMI F47 standards for semiconductor production equipment.

Combining this function with the parameter for Instantaneous Power Cut Hold Time allows the servomotor to continue operating without stopping for an alarm or without recovery work even if the power supply voltage drops.



### IMPORTANT

- This function is able to cope with instantaneous power interruptions in the voltage and time ranges stipulated in SEMI F47. An uninterruptible power supply (UPS) is required as a backup for instantaneous power interruptions that exceed these voltage and time ranges.
- This function is intended for voltage drops in the main circuit power supply. The following restrictions apply when it is used to provide an instantaneous power cut hold time in the control power supply. (There are no restrictions for the 200-VAC SERVOPACKs.)  
<Control Power Supply Restrictions>  
SERVOPACK with 400-VAC Power Input: Provide the control power supply from a 24-VDC power supply that complies with SEMI F47 standards.  
SERVOPACK with 100-VAC Power Input: Provide the control power supply from an uninterruptible power supply (UPS).
- Set the host controller and SERVOPACK force limit so that a force reference that exceeds the specified acceleration will not be output when the power supply for the main circuit is restored.
- Do not limit the force to values lower than the holding force for the vertical axis.
- This function limits force within the range of the SERVOPACK's capability when the power is cut. It is not intended for use under all load and operating conditions. Use the actual machine to set parameters while confirming correct operation.
- Setting the Instantaneous Power Cut Hold Time lengthens the amount of time from when the power supply is turned OFF until the motor current turns OFF. To stop the power supply to the motor immediately, use the servo OFF command.

### (1) Execution Method

This function can be executed either with the host controller and the SERVOPACK or with the SERVOPACK only. Use Pn008.1 to specify whether the function is executed by the host controller and SERVOPACK or by the SERVOPACK only.

#### ■ Execution with the Host Controller (Pn008 = n.□□1□)

The host controller limits the force in response to an undervoltage warning.  
The host controller removes the force limit after the undervoltage warning is cleared.

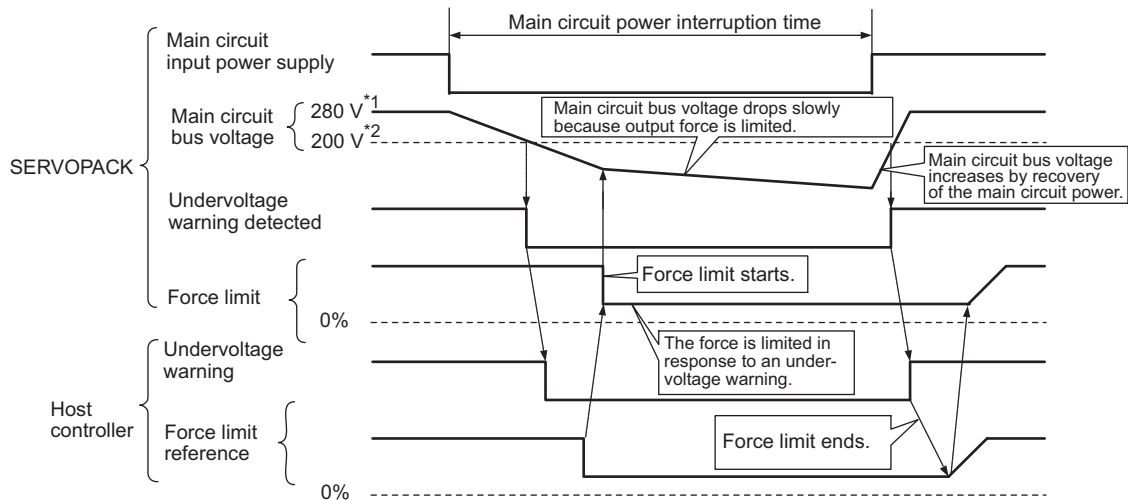

\*1. 560 V for 400-V power supply.  
\*2. 400 V for 400-V power supply.

#### ■ Execution with the SERVOPACK Only (Pn008 = n.□□2□)

The force is limited in the SERVOPACK in response to an undervoltage warning.  
The SERVOPACK controls the force limit value in the set time after the undervoltage warning is cleared.

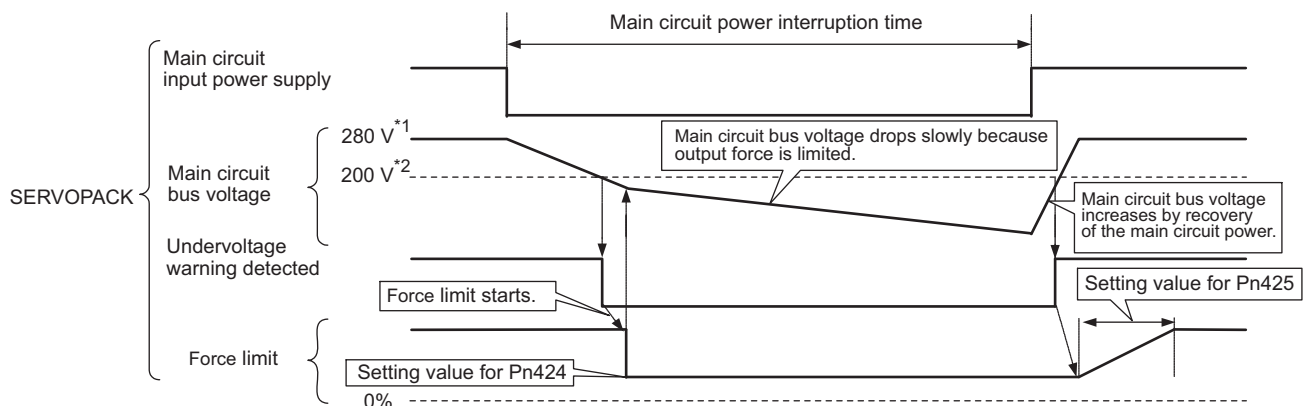

\*1. 560 V for 400-V power supply.  
\*2. 400 V for 400-V power supply.

## (2) Related Parameters

Parameter	Meaning	When Enabled	Classification
Pn008	n.□□0□ [Factory setting]	Does not detect undervoltage.	After restart Setup
	n.□□1□	Detects warning and limits force by host controller.	
	n.□□2□	Detects warning and limits force by Pn424 and Pn425. (Only in the SERVOPACK)	

Pn424	Force Limit at Main Circuit Voltage Drop				Speed	Position	Force	Classification
	Setting Range	Setting Unit	Factory Setting	When Enabled				
	0 to 100	1%*	50	Immediately				Setup
Pn425	Release Time for Force Limit at Main Circuit Voltage Drop				Speed	Position	Force	Classification
	Setting Range	Setting Unit	Factory Setting	When Enabled				
	0 to 1000	1 ms	100	Immediately				Setup
Pn509	Instantaneous Power Cut Hold Time				Speed	Position	Force	Classification
	Setting Range	Setting Unit	Factory Setting	When Enabled				
	20 to 1000	1 ms	20	Immediately				Setup

\* The setting unit is a percentage of the rated force.

Note: When using SEMI F47 function, set 1000 ms.

### 4.2.12 Setting Motor Overload Detection Level

In this SERVOPACK, the detection timing of the warnings and alarms can be changed by changing how to detect an overload warning (A.910) and overload (low load) alarm (A.720).

The overload characteristics and the detection level of the overload (high load) alarm (A.710) cannot be changed.

#### (1) Changing Detection Timing of Overload Warning (A.910)

The overload warning level is set by default to 20% so that an overload warning is detected in 20% of the time required to detect an overload alarm. The time required to detect an overload warning can be changed by changing the setting of the overload warning level (Pn52B). This protective function enables the warning output signal (/WARN) to serve as a protective function and to be output at the best timing for your system.

The following graph shows an example of the detection of an overload warning when the overload warning level (Pn52B) is changed from 20% to 50%. An overload warning is detected in half of the time required to detect an overload alarm.

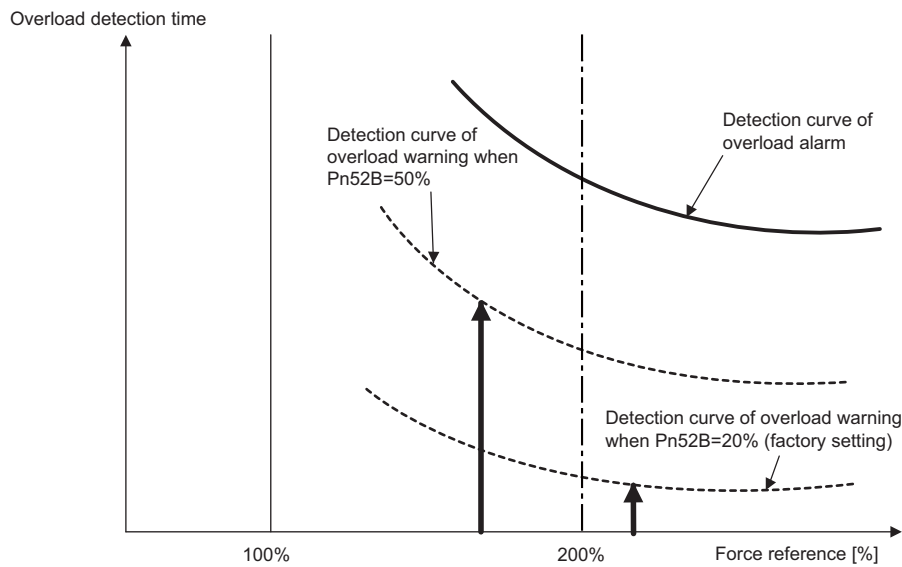

Note: For details, refer to *Overload Characteristics* listed in the section for the relevant servomotor in the *Σ-V Series Product Catalog* (No.: KAEP S800000 42).

<b>Pn52B</b>	Overload Warning Level			<input type="checkbox"/> Speed	<input type="checkbox"/> Position	<input type="checkbox"/> Force	Classification
	Setting Range	Setting Unit	Factory Setting	When Enabled			
	1 to 100	1%	20	Immediately		Setup	

## (2) Changing Detection Timing of Overload (Low Load) Alarm (A.720)

An overload (low load) alarm (A.720) can be detected earlier to protect the servomotor from overloading. The time required to detect an overload alarm can be shortened by using the derated motor base current obtained with the following equation.

Note: The detection level of the overload (high load) alarm (A.710) cannot be changed.

$$\text{Motor base current} \times \text{Derating of base current at detecting overload of motor (Pn52C)} = \text{Derated motor base current}$$

Motor base current: Threshold value of motor current to start calculation for overload alarm  
 Derating of base current at detecting overload of motor (Pn52C): Derating of motor base current

The following graph shows an example of the detection of an overload alarm when Pn52C is set to 50%. The calculation for the overload of motors starts at 50% of the motor base current and then an overload alarm will be detected earlier.

Changing the setting of Pn52C will change the detection timing of the overload alarm, so the time required to detect the overload warning will also be changed.

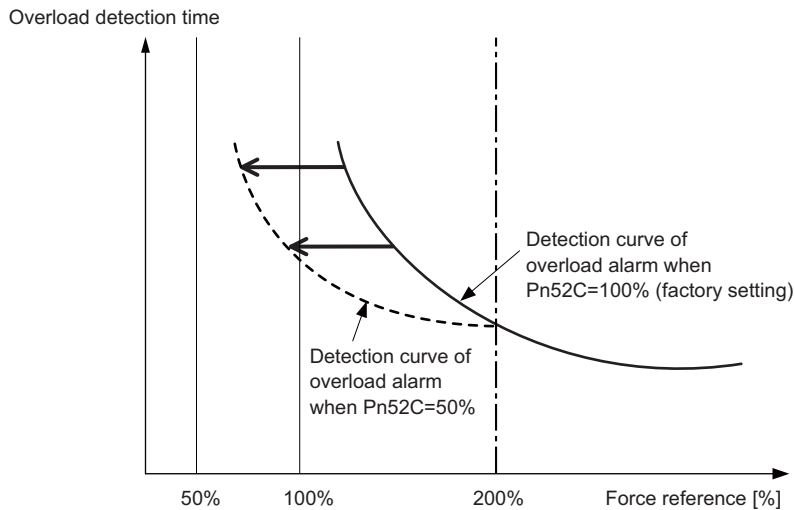

Note: For details, refer to *Overload Characteristics* listed in the section for the relevant servomotor in the *Σ-V Series Product Catalog* (No.: KAEP S800000 42).

<b>Pn52C</b>	Derating of Base Current at Detecting Overload of Motor				Classification
	<input type="checkbox"/> Speed <input type="checkbox"/> Position <input type="checkbox"/> Force				
	Setting Range	Setting Unit	Factory Setting	When Enabled	
	10 to 100	1%	100	After restart	Setup

## 4.3 Test Without Motor Function

The test without a motor is used to check operation of the host controller and peripheral devices by simulating the operation of the servomotor in the SERVOPACK without actually operating the servomotor. This test enables you to check wiring, verify the system while debugging, and verify parameters. This shortens the time required for setup work and prevents damage to the machine that may result from possible malfunctions. This test can check the operation of the servomotor regardless of whether or not it is actually connected.

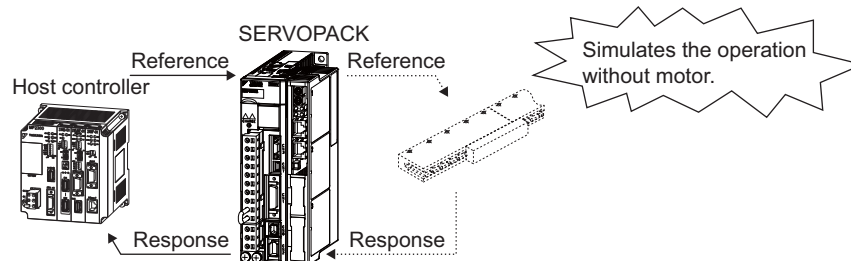

Use Pn00C.0 to enable or disable the test without a motor.

Parameter		Meaning	When Enabled	Classification
Pn00C	n.□□□0 [Factory setting]	Disables the test without a motor.	After restart	Setup
	n.□□□1	Enables the test without a motor.		

### 4.3.1 Motor Information

The motor information that is used for a test without a motor is given below.

#### (1) When Motor is Connected

If a motor is connected, the information from the connected motor and the linear scale is used for the motor and linear scale information. The set value of Pn00C.2 is not used.

#### (2) When Motor is Not Connected

The information for the virtual motor and the linear scale that is stored in the SERVOPACK is used. The set value of Pn00C.2 is used for the linear scale information.

- Resolution: 256
- Scale pitch: The set value of Pn282

#### ■ Encoder Type

The encoder information for the motor is set in Pn00C.2. A linear scale is always regarded as an incremental linear scale.

Parameter		Meaning	When Enabled	Classification
Pn00C	n.□0□□ [Factory setting]	Sets an incremental linear scale as an encoder type for the test without a motor.	After restart	Setup
	n.□1□□	Sets an absolute linear scale as an encoder type for the test without a motor.		

#### ■ Rated Motor Speed and Maximum Motor Speed

The values previously saved in the SERVOPACK will be used for the rated motor speed and maximum motor speed. Use the monitor displays (Un020: Motor rated speed and Un021: Motor maximum speed) to check the values.

### 4.3.2 Motor Position and Speed Responses

For the test without a motor, the following responses are simulated for references from the host controller according to the gain settings for position or speed control.

- Servomotor position
- Servomotor speed
- Linear scale position

The load model, however, will be a rigid system with the mass ratio that is set in Pn103.

### 4.3.3 Limitations

The following functions cannot be used during the test without a motor.

- Regeneration and dynamic brake operation
- Brake output signal (The brake output signal can be checked with the I/O signal monitor function of the SigmaWin+.)
- Items marked with "×" in the following utility function table.

Fn No.	Contents	Can be used or not	
		Motor not connected	Motor connected
Fn000	Alarm history display	○	○
Fn002	JOG operation	○	○
Fn003	Origin search	○	○
Fn004	Program JOG operation	○	○
Fn005	Initializing parameter settings	○	○
Fn006	Clearing alarm history	○	○
Fn00C	Offset adjustment of analog monitor output	○	○
Fn00D	Gain adjustment of analog monitor output	○	○
Fn00E	Automatic offset-signal adjustment of the motor current detection signal	×	○
Fn00F	Manual offset-signal adjustment of the motor current detection signal	×	○
Fn010	Write prohibited setting	○	○
Fn011	Servomotor model display	○	○
Fn012	Software version display	○	○
Fn014	Resetting configuration error in option modules	○	○
Fn01B	Vibration detection level initialization	×	×
Fn01E	Display of SERVOPACK and servomotor ID	○	○
Fn020	Origin setting	×	○
Fn030	Software reset	○	○
Fn080	Polarity Detection	×	×
Fn200	Tuning-less levels setting	×	×
Fn201	Advanced autotuning	×	×
Fn202	Advanced autotuning by reference	×	×
Fn203	One-parameter tuning	×	×
Fn204	Anti-resonance control adjustment function	×	×
Fn205	Vibration suppression function	×	×
Fn206	EasyFFT	×	×
Fn207	Online vibration monitor	×	×

Note: ○: Can be used  
×: Cannot be used

### 4.3.4 Digital Operator Displays during Testing without Motor

An asterisk (\*) is displayed before status display to indicate the test without a motor operation is in progress.

*BB	-PRM/MON-
Un000=	00000
Un002=	00000
Un008=	0000000000
Un00D=	0000000000

(Example: Status of power to the servomotor is OFF)

Display	Status
*RUN	Power is supplied to the servomotor.
*BB	Power to the servomotor is OFF.
*P DET	The polarity is being detected.
*PT NT	Forward or reverse run is prohibited.
*P-OT	Forward run is prohibited.
*N-OT	Reverse run is prohibited.
*HBB	In hard-wire base block (safety) state.

Note: The test without a motor status is not displayed during alarm occurs (A.□□□).

## 4.4 Limiting Force

The SERVOPACK provides the following three methods for limiting output force to protect the machine.

Limiting Method	Description	Reference Section
Internal force limit	Always limits force by setting the parameter.	4.4.1
External force limit	Limits force by input signal from the host controller.	4.4.2
Force limit with command option module	Limits force by inputting a desired force limit command to the command option module from the host controller.	Refer to the manual of the connected command option module.

Note: The maximum force of the servomotor is used when the set value exceeds the maximum force.

### 4.4.1 Internal Force Limit

This function always limits maximum output force by setting values of following parameters.

<b>Pn483</b>	Forward Force Limit <span style="float:right">Speed   Position   Force</span>				Classification
	Setting Range	Setting Unit	Factory Setting	When Enabled	
	0 to 800	1%*	30	Immediately	Setup
<b>Pn484</b>	Reverse Force Limit <span style="float:right">Speed   Position   Force</span>				Classification
	Setting Range	Setting Unit	Factory Setting	When Enabled	
	0 to 800	1%*	30	Immediately	Setup

\* Percentage (%) of rated motor force.

Note: If the settings of Pn483 and Pn484 are too low, the force may be insufficient for acceleration or deceleration of the servomotor.

Force waveform

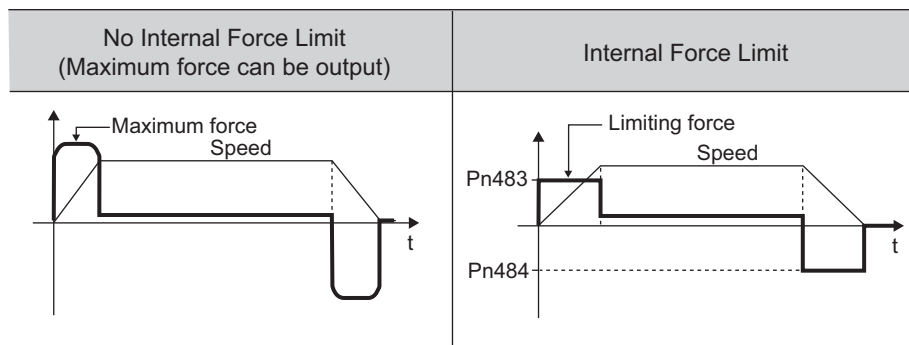

## 4.4.2 External Force Limit

Use this function to limit force by inputting a signal from the host controller at specific times during machine operation. For example, some pressure must continually be applied (but not enough to damage the workpiece) when the robot is holding a workpiece or when a device is stopping on contact.

### (1) Input Signals

Use the following input signals to limit a force by external force limit.

Type	Signal Name	Connector Pin Number	Setting	Meaning	Limit value
Input	/P-CL	Must be allocated	ON (closed)	Forward external force limit ON	The smaller value of these settings: Pn483 or Pn404
			OFF (open)	Forward external force limit OFF	Pn483
Input	/N-CL	Must be allocated	ON (closed)	Reverse external force limit ON	The smaller value of these settings: Pn484 or Pn405
			OFF (open)	Reverse external force limit OFF	Pn484

Note: Use parameter Pn50B.2 and Pn50B.3 to allocate the /P-CL signal and the /N-CL signal for use. For details, refer to 3.3.1 *Input Signal Allocations*.

### (2) Related Parameters

Set the following parameters for external force limit.

<b>Pn483</b>	Forward Force Limit <span style="float:right">Speed Position Force</span>				Classification
	Setting Range	Setting Unit	Factory Setting	When Enabled	
	0 to 800	1%*	30	Immediately	Setup
<b>Pn484</b>	Reverse Force Limit <span style="float:right">Speed Position Force</span>				Classification
	Setting Range	Setting Unit	Factory Setting	When Enabled	
	0 to 800	1%*	30	Immediately	Setup
<b>Pn404</b>	Forward External Force Limit <span style="float:right">Speed Position Force</span>				Classification
	Setting Range	Setting Unit	Factory Setting	When Enabled	
	0 to 800	1%*	100	Immediately	Setup
<b>Pn405</b>	Reverse External Force Limit <span style="float:right">Speed Position Force</span>				Classification
	Setting Range	Setting Unit	Factory Setting	When Enabled	
	0 to 800	1%*	100	Immediately	Setup

\* Percentage (%) of rated motor force.

Note: If the settings of Pn483, Pn484, Pn404, and Pn405 are too low, the force may be insufficient for acceleration or deceleration of the servomotor.

### (3) Changes in Output Force during External Force Limiting

The following diagrams show the change in output force when the internal force limit is set to 800%.

In this example, the servomotor movement direction is Pn000.0 = 0 (Sets the linear scale counting up direction as the forward direction).

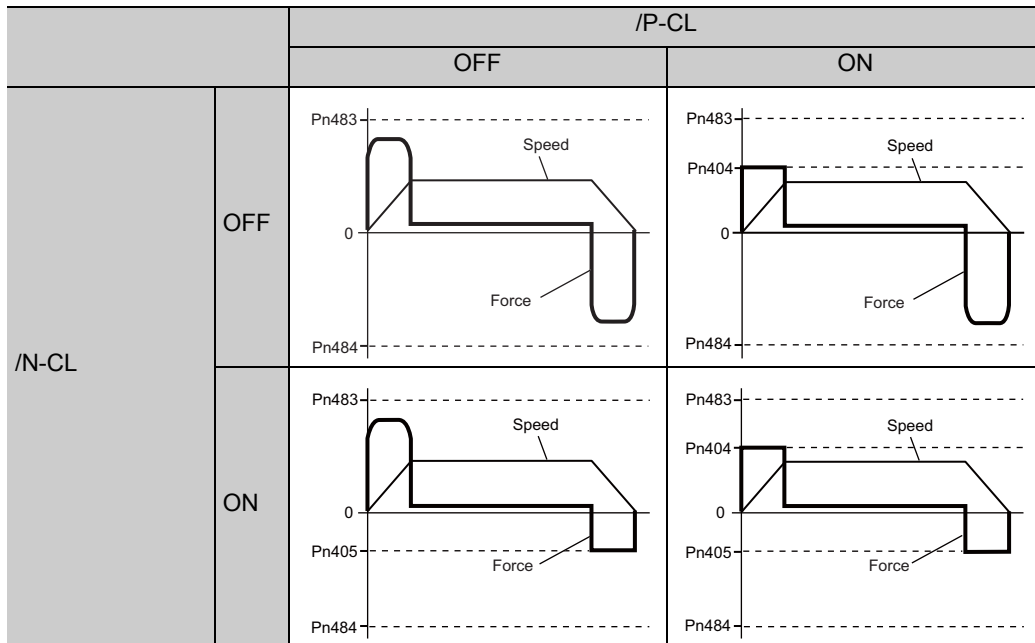

### 4.4.3 Checking Output Force Limiting during Operation

The following signal can be output to indicate that the servomotor output force is being limited.

Type	Signal Name	Connector Pin Number	Setting	Meaning
Output	/CLT	Must be allocated	ON (closed)	Servomotor output force is being limited.
			OFF (open)	Servomotor output force is not being limited.

Note: Use parameter Pn50F.0 to allocate the /CLT signal for use. For details, refer to 3.3.2 *Output Signal Allocations*.

## 4.5 Absolute Linear Scales

If using an absolute linear scale, a system to detect the absolute position can be designed for use with the host controller. As a result, an operation can be performed without a zero point return operation immediately after the power is turned ON.

For details on how to set up the absolute linear scale, refer to *5 Trial Operation (Checking Linear Servomotor Operation)* in the *Σ-V Series User's Manual, Setup, Linear Motor* (No.: SIEP S800000 44).

Set Pn002 to n.□0□□ (factory setting) when you use an absolute linear scale.

Parameter	Meaning	When Enabled	Classification
Pn002	n.□0□□ [Factory setting]	Uses the absolute linear scale as an absolute linear scale.	After restart
	n.□1□□	Uses the absolute linear scale as an incremental linear scale.	

### 4.5.1 Absolute Data Request (Sensor ON Command)

You must input the sensor ON command to output the absolute data from the SERVOPACK.

The sensor ON command is turned ON at the following timing.

Note: The command method depends on the connected command option module. For details, refer to the manual for the connected command option module.

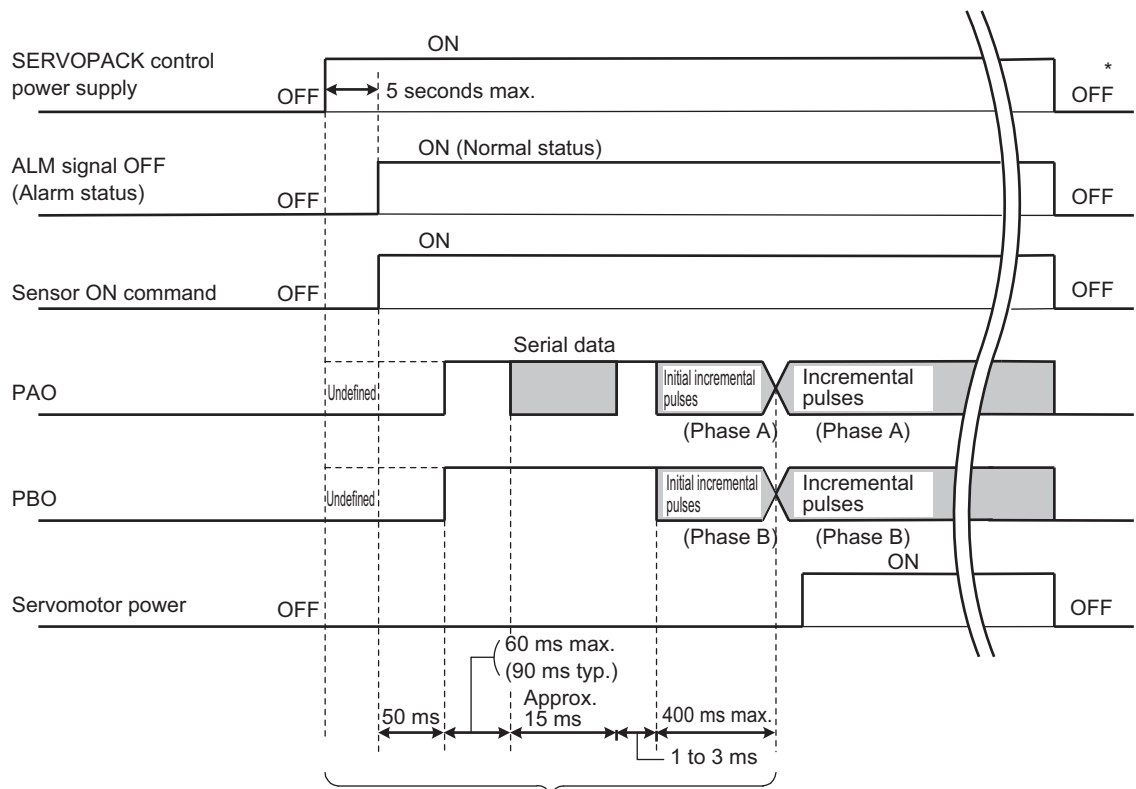

The servomotor will not be turned ON even if the servo ON command is received during this interval.

\* Turn OFF the sensor ON command when you turn OFF the control power supply.

### 4.5.2 Absolute Data Reception Sequence

The sequence in which the SERVOPACK receives outputs from the absolute linear scale and transmits them to host controller is shown below.

#### (1) Outline of Absolute Data

The serial data, pulses, etc., of the absolute linear scale that are output from the SERVOPACK are output from the PAO, PBO, and PCO signals as shown below.

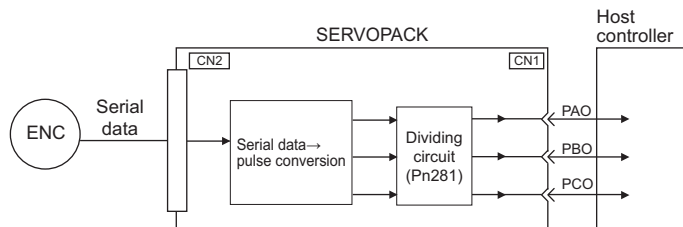

Signal Name	Status	Contents
PAO	At initialization	Serial data Initial incremental pulses
	Normal Operations	Incremental pulses
PBO	At initialization	Initial incremental pulses
	Normal Operations	Incremental pulses
PCO	Always	Origin pulses

#### Phase-C Output Specifications

The pulse width of phase C (origin pulse) changes depending on the encoder output resolution (Pn281), becoming the same width as phase A.

The output timing is one of the following.

- Synchronized with the rising edge of phase A
- Synchronized with the falling edge of phase A
- Synchronized with the rising edge of phase B
- Synchronized with the falling edge of phase B

Note: When host controller receives the data of absolute linear scale, do not perform counter reset using the output of PCO signal.

#### (2) Absolute Data Reception Sequence

1. Send the sensor ON command from the host controller.
2. After 100 ms, the system is set to serial data reception standby and the incremental pulse up/down counter is cleared to zero.
3. Eight characters of serial data is received.
4. The system enters a normal incremental operation state about 400 ms after the last serial data is received.

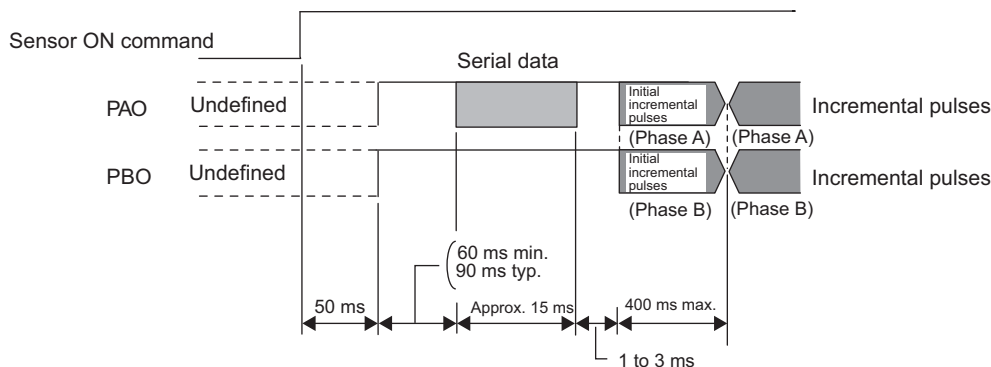

## &lt;NOTE&gt;

- The output pulses are phase-B advanced if the servomotor is moving forward regardless of the setting in Pn000.0.
- The command method for the sensor ON command depends on the connected command option module. For details, refer to the manual for the connected command option module.

Serial data:

Outputs the current position as serial data after dividing using the value set at Pn281.

Unit: 1048576 pulse/serial data "1"

Initial incremental pulses:

Outputs the current position as pulse data after dividing using the value set at Pn281.

Pulse range: 0 to 1048576 pulse

Output pulse rate: Approx. 0.37  $\mu$ s

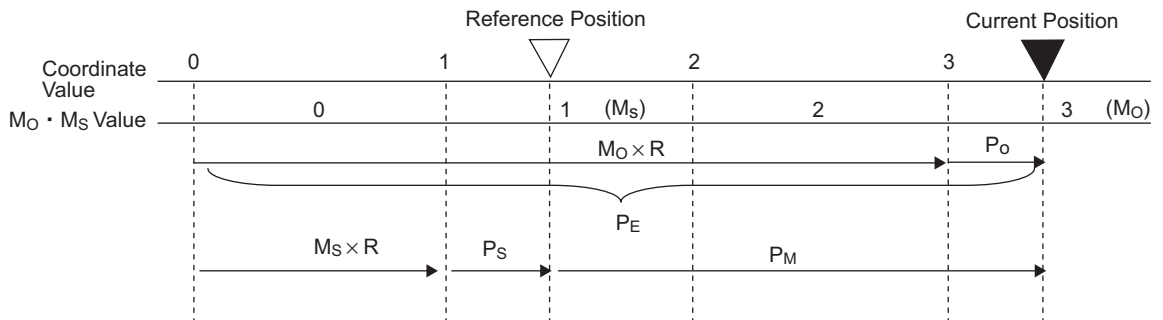

Final absolute data  $P_M$  is calculated by following formula.

$$P_E = M_O \times R + P_O$$

$$P_M = P_E - M_S \times R - P_S$$

Note: In the case of reverse direction mode (Pn000.0 = 1), use the above-mentioned formula.

Abbreviation	Meaning
$P_E$	Current value of linear scale
$M_O$	Serial data value at current position
$P_O$	Initial incremental pulses at current position
$M_S$	Serial data value at reference position
$P_S$	Initial incremental pulses at reference position
$P_M$	Current value required for the user's system.
R	1048576

Note: When processing the absolute linear scale reception sequence, do not perform counter reset using PCO output.

### (3) Serial Data Specifications and Initial Incremental Pulses

#### ■ Serial Data Specifications

The serial data is output from PAO signal.

Data Transfer Method	Start-stop Synchronization (ASYNC)
Baud rate	9600 bps
Start bits	1 bit
Stop bits	1 bit
Parity	Even
Character code	ASCII 7-bit code
Data format	8 characters, as shown below. <div style="text-align: center;"> </div> <p>Note 1. The range for absolute data is "P+00000" (CR) or "P-00000" (CR).                  Note 2. The serial data range is "-32768" to "+32767". When this range is exceeded, the data changes from "+32767" to "-32768" or from "-32768" to "+32767".                  Note 3. In the case of reverse direction mode (Pn000.0 = 1), the sign reverses.</p>

#### ■ Initial Incremental Pulses

The initial incremental pulses are output after division inside the SERVOPACK in the same way as for normal incremental pulses. Refer to 4.2.5 Encoder Output Pulses for details.

### (4) Transferring Alarm Contents

If an absolute linear scale is used, the contents of alarms detected by the SERVOPACK are transmitted in serial data to the host controller from the PAO output when the sensor ON command changes from ON to OFF.

Note: A change to OFF in the sensor ON command is not accepted while the servomotor power is ON.

Output example of alarm contents are as shown below.

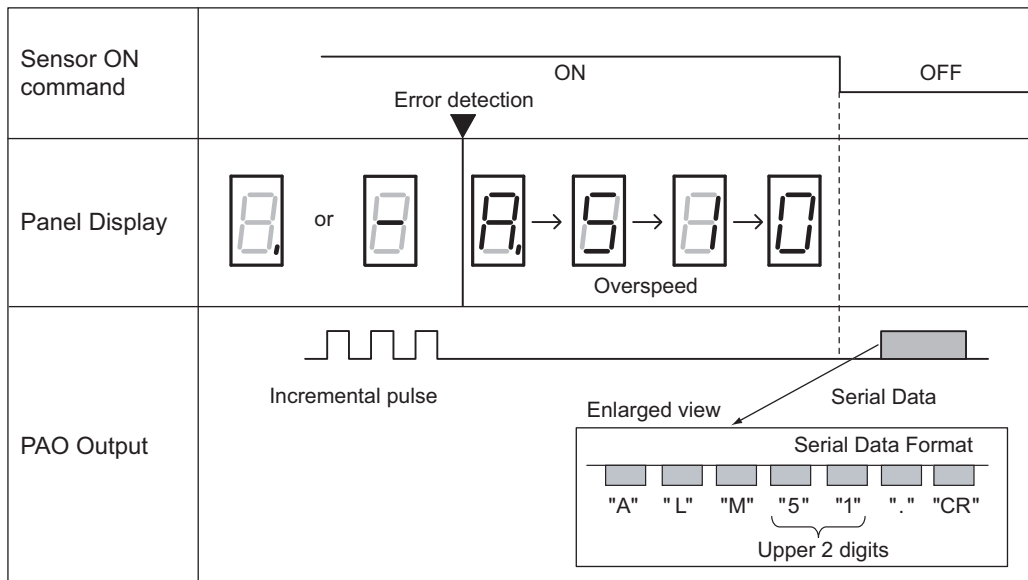

## 4.6 Other Output Signals

This section explains other output signals.

Use these signals according to the application needs, e.g., for machine protection.

### 4.6.1 Servo Alarm Output Signal (ALM)

This section describes signals that are output when the SERVOPACK detects errors and resetting methods.

#### (1) Servo Alarm Output Signal (ALM)

This signal is output when the SERVOPACK detects an error.

 <b>IMPORTANT</b>	<p>Configure an external circuit so that this alarm output turns OFF the main circuit power supply for the SERVOPACK whenever an error occurs.</p>
---	--

Type	Signal Name	Connector Pin Number	Setting	Meaning
Output	ALM	CN1-3, 4	ON (closed)	Normal SERVOPACK status
			OFF (open)	SERVOPACK alarm status

#### (2) Alarm Reset Method

If a servo alarm (ALM) occurs, use one of the following methods to reset the alarm after eliminating the cause of the alarm.

 <b>IMPORTANT</b>	<p>Be sure to eliminate the cause of the alarm before resetting it. If the alarm is reset and operation continued without eliminating the cause of the alarm, it may result in damage to the equipment or fire.</p>
---	---

#### ■ Resetting Alarms with the Command Option Module's Alarm Clear Command

For details, refer to the manual for the connected command option module.

#### ■ Resetting Alarms with the Digital Operator

Press the ALARM RESET Key on the digital operator. For details on how to use the digital operator, refer to the *Σ-V Series User's Manual of Digital Operator* (No.: SIEP S800000 55).

### 4.6.2 Warning Output Signal (/WARN)

This signal is for a warning issued before the occurrence of an alarm.  
Refer to 8.2.1 *List of Warnings*.

#### ■ Signal Specifications

Type	Signal Name	Connector Pin Number	Setting	Meaning
Output	/WARN	Must be allocated	ON (closed)	Warning status
			OFF (open)	Normal status

Note: Use parameter Pn50F.3 to allocate the /WARN signal for use. For details, refer to 3.3.2 *Output Signal Allocations*.

### 4.6.3 Movement Detection Output Signal (/TGON)

This output signal indicates that the servomotor is moving at the speed set for Pn581 or a higher speed.

#### (1) Signal Specifications

Type	Signal Name	Connector Pin Number	Setting	Meaning
Output	/TGON	Must be allocated	ON (closed)	Servomotor is moving with the motor speed above the setting in Pn581.
			OFF (open)	Servomotor is moving with the motor speed below the setting in Pn581.

Note: Use parameter Pn50E.2 to allocate the /TGON signal for use. For details, refer to 3.3.2 *Output Signal Allocations*.

#### (2) Related Parameter

Set the range in which the /TGON signal is output using the following parameter.

Pn581	Zero Speed Level				Classification
	Setting Range	Setting Unit	Factory Setting	When Enabled	
	1 to 10000	1 mm/s	20	Immediately	

### 4.6.4 Servo Ready Output Signal (/S-RDY)

This signal turns ON when the SERVOPACK is ready to accept the servo ON command.

The /S-RDY signal is turned ON under the following conditions.

- The main circuit power supply is ON.
- No hard wire base block state
- No servo alarms
- The sensor ON command is being input when using an absolute linear scale.
- Polarity detection has been completed. (When a servomotor without a hall sensor is used.)\*

<NOTE>

- When using an absolute linear scale and the sensor ON command is being input, the absolute value output to the host controller must also have been completed.
- For details on the hard wire base block function, refer to 4.7.1 *Hard Wire Base Block (HWBB) Function*.

\* This condition does not apply to the first time the servo ON command is input after the control power supply is turned ON. The first time the servo ON command is input, polarity detection is started in sync with the command and the /S-RDY signal is turned ON after polarity detection is completed. A timing chart for polarity detection is given below.

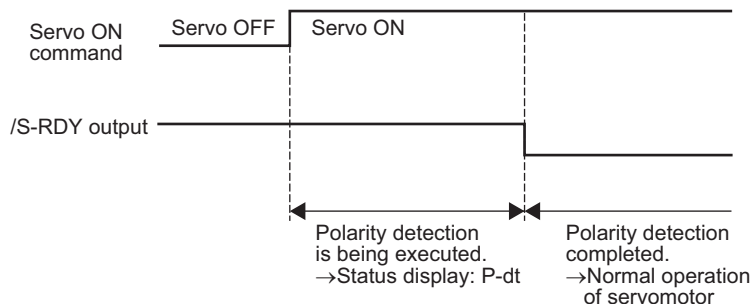

## ■ Signal Specifications

Type	Signal Name	Connector Pin Number	Setting	Meaning
Output	/S-RDY	Must be allocated	ON (closed)	The SERVOPACK is ready to accept the servo ON command.
			OFF (open)	The SERVOPACK is not ready to accept the servo ON command.

- Note 1. Use parameter Pn50E.3 to allocate the /S-RDY signal for use. For details, refer to 3.3.2 *Output Signal Allocations*.
2. For details on the hard wire base block function and the servo ready output signal, refer to 4.7.1 *Hard Wire Base Block (HWBB) Function*.

### 4.6.5 Speed Coincidence Output Signal (/V-CMP)

The speed coincidence output signal (/V-CMP) is output when the actual servomotor speed is the same as the reference speed. The host controller uses the signal as an interlock. This signal is the output signal during speed control.

Type	Signal Name	Connector Pin Number	Setting	Meaning
Output	/V-CMP	Must be allocated	ON (closed)	Speed coincides.
			OFF (open)	Speed does not coincide.

Note: Use parameter Pn50E.1 to allocate the /V-CMP signal for use. Refer to 3.3.2 *Output Signal Allocations* for details.

Pn582	Speed Coincidence Signal Output Width				Classification
	Setting Range	Setting Unit	Factory Setting	When Enabled	
	0 to 100	1 mm/s	10	Immediately	Setup

The /V-CMP signal is output when the difference between the reference speed and actual motor speed is below this setting.

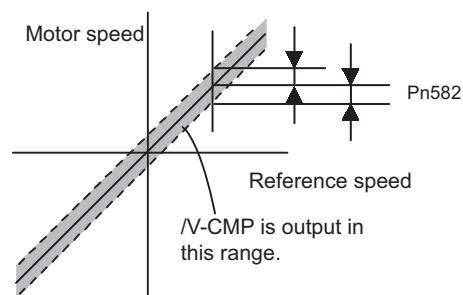

#### <Example>

The /V-CMP signal is output at 1900 to 2100 mm/s if the Pn582 is set to 100 and the reference speed is 2000 mm/s.

## 4.6.6 Positioning Completed Output Signal (/COIN)

This signal indicates that servomotor movement has been completed during position control.

When the difference between the number of references output by the host controller and the travel distance of the servomotor (position error) drops below the set value in the parameter, the positioning completion signal will be output.

Use this signal to check the completion of positioning from the host controller.

Type	Signal Name	Connector Pin Number	Setting	Meaning
Output	/COIN	Must be allocated	ON (closed)	Positioning has been completed.
			OFF (open)	Positioning is not completed.

Note: Use parameter Pn50E.0 to allocate the /COIN signal for use. Refer to 3.3.2 *Output Signal Allocations* for details.

Pn522	Positioning Completed Width				Classification
	Setting Range	Setting Unit	Factory Setting	When Enabled	
	0 to 1073741824	1 reference unit	7	Immediately	Setup

The positioning completed width setting has no effect on final positioning accuracy.

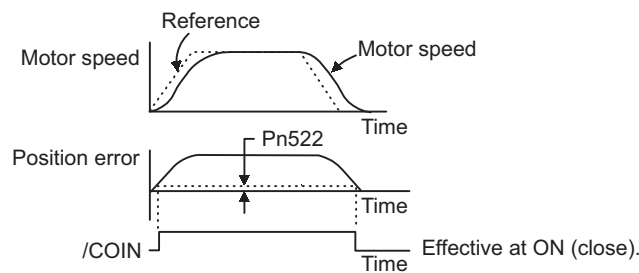

Note: If the parameter is set to a value that is too large, a positioning completed signal might be output if the position error is low during a low speed operation. This will cause the positioning completed signal to be output continuously. If this signal is output unexpectedly, reduce the set value until it is no longer output.

If the position error is kept to a minimum when the positioning completed width is small, use Pn207.3 to change output timing for the /COIN signal.

Parameter	Name	Meaning	When Enabled	Classification
Pn207	n.0□□□ [Factory setting]	When the absolute value of the position error is below the positioning completed width (Pn522).	After restart	Setup
	n.1□□□	When the absolute value of the position error is below the positioning completed width (Pn522), and the reference after applying the position reference filter is 0.		
	n.2□□□	When the absolute value of the position error is below the positioning completed width (Pn522), and the position reference input is 0.		

### 4.6.7 Positioning Near Output Signal (/NEAR)

Before confirming that the positioning completed signal has been received, the host controller first receives a positioning near signal and can prepare the operating sequence after positioning has been completed. The time required for this sequence after positioning can be shortened.

This signal is generally used in combination with the positioning completed output signal.

Type	Signal Name	Connector Pin Number	Setting	Meaning
Output	/NEAR	Must be allocated	ON (closed)	The servomotor has reached a point near to positioning completed.
			OFF (open)	The servomotor has not reached a point near to positioning completed.

Note: Use parameter Pn510.0 to allocate the /NEAR signal for use. Refer to 3.3.2 *Output Signal Allocations* for details.

Pn524	NEAR Signal Width				Classification
	Setting Range	Setting Unit	Factory Setting	When Enabled	
	1 to 1073741824	1 reference unit	1073741824	Immediately	Setup

The positioning near signal (/NEAR) is output when the difference between the number of references output by the host controller and the travel distance of the servomotor (position error) is less than the set value.

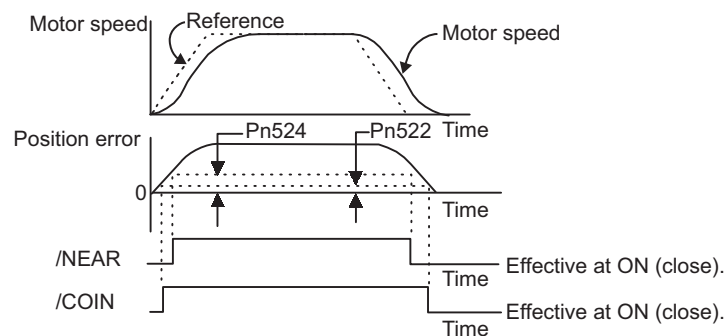

Note: Normally, the value of Pn524 should be larger than that for the positioning completed width (Pn522).

### 4.6.8 Speed Limit Detection Signal (/VLT)

This function limits the speed of the servomotor to protect the machine.

A servomotor in force control is controlled to output the specified force, but the motor speed is not controlled. Therefore, if an excessive reference force is set for the load force on the machinery side, the speed of the servomotor may increase greatly. If that may occur, use this function to limit the speed.

Note: The actual limit value of motor speed depends on the load conditions of the servomotor.

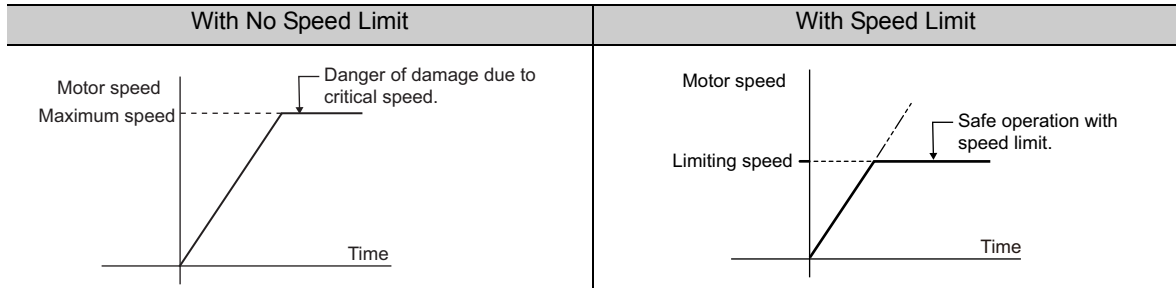

The parameters related to the speed limit, such as for selecting the speed limit method, are described next.

#### (1) Signals Output during Servomotor Speed Limit

The following signal is output when the motor speed reaches the limit speed.

Type	Signal Name	Connector Pin Number	Setting	Meaning
Output	/VLT	Must be allocated	ON (closed)	Servomotor speed limit being applied.
			OFF (open)	Servomotor speed limit not being applied.

Note: Use parameter Pn50F.1 to allocate the /VLT signal for use. For details, refer to 3.3.2 *Output Signal Allocations*.

#### (2) Speed Limit Setting

Select the speed limit mode with Pn002.1.

Parameter	Meaning	When Enabled	Classification
<b>Pn002</b>	n.□□0□ [Factory setting]	After restart	Setup
	n.□□1□		

### ■ Internal Speed Limit Function

If the internal speed limit function is selected in Pn002.1, set the limit of the maximum speed of the servomotor in Pn480. The limit of the speed in Pn408.1 can be either the maximum speed of the servomotor or the overspeed alarm detection speed. Select the overspeed alarm detection speed to limit the speed to the maximum speed of the servomotor or the equivalent.

<b>Pn480</b>	Speed Limit During Force Control <span style="float: right;">Force</span>				Classification
	Setting Range	Setting Unit	Factory Setting	When Enabled	
	0 to 10000	1 mm/s	10000	Immediately	Setup

Note: The servomotor's maximum speed or the overspeed alarm detection speed will be used when the setting in this parameter exceeds the maximum speed of the servomotor used.

Parameter		Meaning	When Enabled	Classification
<b>Pn408</b>	n.□□0□ [Factory setting]	Uses the smaller value of the maximum motor speed and the value of Pn480 as the speed limit value.	After restart	Setup
	n.□□1□	Uses the smaller value of the overspeed alarm detection speed and the value of Pn480 as speed limit value.		

### ■ External Speed Limit Function

If the external speed limit mode is selected in Pn002.1, the motor speed is controlled by the speed limit reference. For details, refer to the manual for the connected command option module.

## 4.7 Safety Function

The safety function is incorporated in the SERVOPACK to reduce the risk associated with the machine by protecting workers from injury and by securing safe machine operation. Especially when working in hazardous areas inside the safeguard, as for machine maintenance, it can be used to avoid adverse machine movement.

### 4.7.1 Hard Wire Base Block (HWBB) Function

The Hard Wire Base Block function (hereinafter referred to as HWBB function) is a safety function designed to baseblock the servomotor (shut off the motor current) by using the hardwired circuits. Each circuit for two channel input signals blocks the run signal to turn off the power module that controls the motor current, and the motor current is shut off.



**IMPORTANT**

For the safety function signal connections, the input signal is the 0 V common and the output signal is the source output. This is opposite to other signals described in this manual. To avoid confusion, the ON and OFF status of signals for the safety functions are defined as follows:

**ON:** The state in which the relay contacts are closed or the transistor is ON and current flows into the signal line.

**OFF:** The state in which the relay contacts are open or the transistor is OFF and no current flows into the signal line.

The input signals are connected to the 0 V common. A connection example is provided in the following figure.

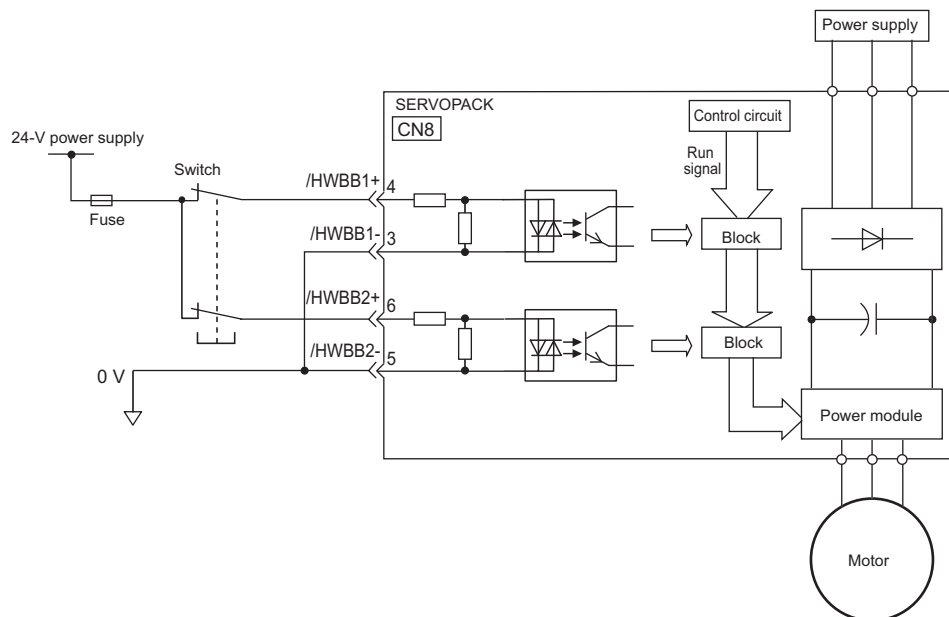

### (1) Risk Assessment

When using the HWBB function, be sure to perform a risk assessment of the servo system in advance. Make sure that the safety level of the standards is met. For details on the standards, refer to *Harmonized Standards* in the front of this manual.

Note: To meet the performance level d (PLd) in EN ISO 13849-1, the EDM signal must be monitored by a host controller. If the EDM signal is not monitored by a host controller, the system only qualifies for the performance level c (PLc).

The following risks can be estimated even if the HWBB function is used. These risks must be included in the risk assessment.

- The servomotor will move in an application where external force is applied to the servomotor (for example, gravity on the vertical axis). Take measures to secure the servomotor, such as installing a mechanical brake.
- The servomotor may move within the electric angle of 180 degrees in case of the power module failure, etc. Make sure that safety is ensured even in that situation. The movement distance depends on the motor type. The maximum movement distance is given below.  
Linear motor: 50 mm max.
- The HWBB function does not shut off the power to the SERVOPACK or electrically isolate it. Take measures to shut off the power to the SERVOPACK when performing maintenance on it.

### (2) Hard Wire Base Block (HWBB) State

The SERVOPACK will be in the following state if the HWBB function operates. If the /HWBB1 or /HWBB2 signal is OFF, the HWBB function will operate and the SERVOPACK will enter a hard wire baseblock (HWBB) state.

The HWBB function operates after the servomotor power is turned OFF.

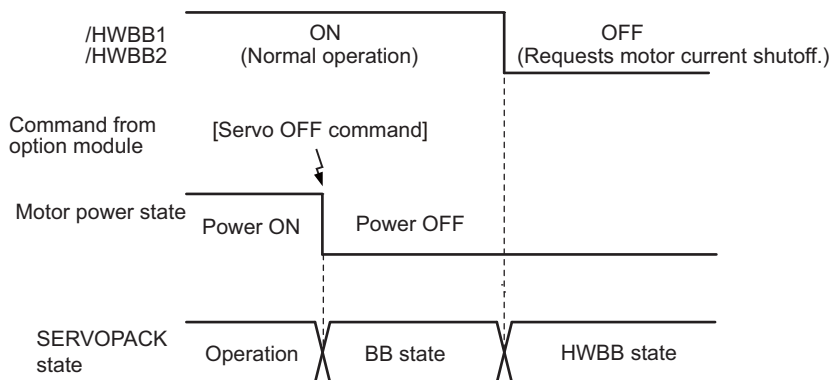

The HWBB function operates while the servomotor power is ON.

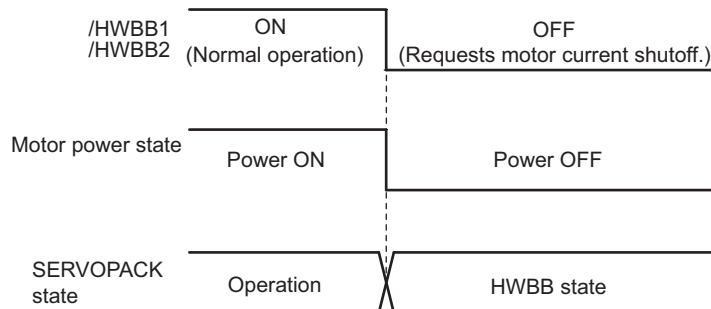

### (3) Resetting the HWBB State

If the /HWBB1 or /HWBB2 signal is OFF and the servo ON command is received, the hardwire baseblock (HWBB) state will be maintained, even if the /HWBB1 and /HWBB2 signals both become ON.

Input the servo ON command again after the servo OFF command is received and the SERVOPACK enters the BB state.

For details on the servo ON/OFF commands, refer to the manual for the connected command option module.

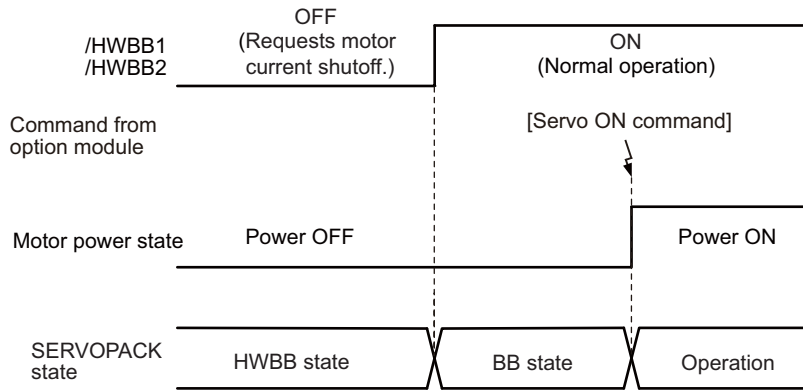

Note: Even if a baseblock is implemented by turning OFF the main circuit power supply, the HWBB state will be maintained until the servo OFF command is input.

### (4) Error Detection in HWBB Signal

If only the /HWBB1 or /HWBB2 signal is input, an A.Eb1 alarm (Safety Function Signal Input Timing Error) will occur unless the other signal is input within 10 seconds. This makes it possible to detect failures, such as disconnection of the HWBB signals.



## CAUTION

- The safety function signal input timing error alarm (A.Eb1) is not a safety-related part of a control system. Keep this in mind in the system design.

### (5) Connection Example and Specifications of Input Signals (HWBB Signals)

The input signals must be redundant. A connection example and specifications of input signals (HWBB signals) are shown below.



**IMPORTANT**

For safety function signal connections, the input signal is the 0 V common and the output signal is the source output. This is opposite to other signals described in this manual. To avoid confusion, the ON and OFF status of signals for safety functions are defined as follows:

**ON:** The state in which the relay contacts are closed or the transistor is ON and current flows into the signal line.

**OFF:** The state in which the relay contacts are open or the transistor is OFF and no current flows into the signal line.

#### ■ Connection Example

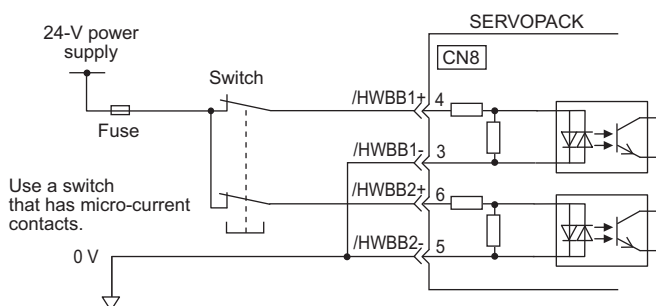

#### ■ Specifications

Type	Signal Name	Connector Pin Number	Setting	Meaning
Input	/HWBB1	CN8-4 CN8-3	ON (closed)	Does not use the HWBB function. (normal operation)
			OFF (open)	Uses the HWBB function. (motor current shut-off request)
	/HWBB2	CN8-6 CN8-5	ON (closed)	Does not use the HWBB function. (normal operation)
			OFF (open)	Uses the HWBB function. (motor current shut-off request)

The input signals (HWBB signals) have the following electrical characteristics.

Items	Characteristics	Remarks
Internal Impedance	3.3 kΩ	—
Operation Movable Voltage Range	+11 to +25 V	—
Maximum Delay Time	20 ms	Time from the /HWBB1 and /HWBB2 signals are OFF to the HWBB function operates.

If the HWBB function is requested by turning OFF the /HWBB1 and /HWBB2 input signals on the two channels, the power supply to the servomotor will be turned OFF within 20 ms (see below).

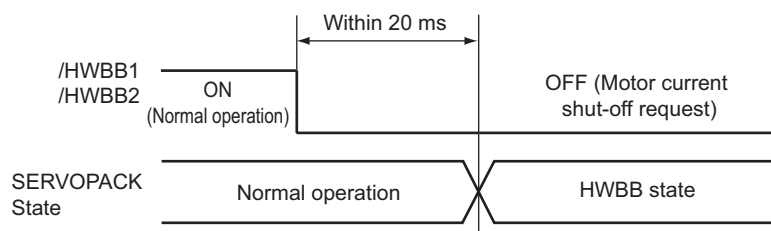

Note 1. The OFF status is not recognized if the total OFF time of the /HWBB1 and /HWBB2 signals is 0.5 ms or shorter.  
 2. The status of the input signals can be checked using monitor displays. For details, refer to 7.5 *Monitoring Safety Input Signals*.

## (6) Operation with Utility Functions

The HWBB function works while the SERVOPACK operates in the utility function.

If any of the following utility functions is being used with the /HWBB1 and /HWBB2 signals turned OFF, the SERVOPACK cannot be operated by turning ON the /HWBB1 and /HWBB2 signals. Cancel the utility function first, and then set the SERVOPACK to the utility function again and restart operation.

- JOG operation (Fn002)
- Origin search (Fn003)
- Program JOG operation (Fn004)
- Advanced autotuning (Fn201)
- EasyFFT (Fn206)
- Automatic offset-signal adjustment of motor current detection signal (Fn00E)

## (7) Servo Ready Output (/S-RDY)

The servo ready output will turn OFF because the servo ON command cannot be accepted in the HWBB state. The servo ready output will turn ON if the servomotor power is OFF (set to BB state) when both the /HWBB1 and /HWBB2 signals are ON.

The following diagram shows an example where the main circuit power supply is turned ON, the sensor ON command is input\* (with an absolute encoder), and no servo alarm occurs.

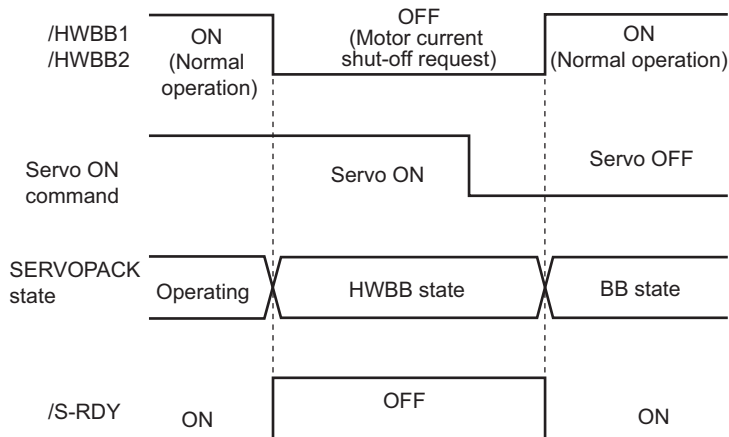

\* The command method for the sensor ON command depends on the connected command option module. For details, refer to the manual for the connected command option module.

## (8) Brake Signal (/BK)

When the /HWBB1 or /HWBB2 signal is OFF and the HWBB function operates, the brake signal (/BK) will turn OFF. At that time, Pn506 (brake reference - servo OFF delay time) will be disabled. Therefore, the servomotor may be moved by external force until the actual brake becomes effective after the brake signal (/BK) turns OFF.

### ⚠ CAUTION

- The brake signal is not a safety-related part of a control system. Be sure to design the system so that the system will not be put into danger if the brake signal fails in the HWBB state.

## (9) Dynamic Brake

If the dynamic brake is enabled in Pn001.0 (Stopping Method for Servomotor after servo OFF Command is Received), the servomotor will come to a stop under the control of the dynamic brake when the HWBB function works while the /HWBB1 or /HWBB2 signal is OFF.

### CAUTION

- The dynamic brake is not a safety-related part of a control system. Be sure to design the system so that the system will not be put into danger if the servomotor coasts to a stop in the HWBB state. Usually, use a sequence in which the HWBB state occurs after the servomotor is stopped using the reference.
- If the application frequently uses the HWBB function, do not use the dynamic brake to stop the servomotor. Otherwise element deterioration in the SERVOPACK may result. To prevent internal elements from deteriorating, use a sequence in which the HWBB state occurs after the servomotor has come to a stop.

## (10) Servo Alarm Output Signal (ALM)

In the HWBB state, the servo alarm output signal (ALM) is not sent.

### 4.7.2 External Device Monitor (EDM1)

The external device monitor (EDM1) functions to monitor failures in the HWBB function. Connect the monitor to feedback signals to the safety function device.

Note: To meet the performance level d (PLd) in EN ISO13849-1, the EDM signal must be monitored by a host controller. If the EDM signal is not monitored by a host controller, the system only qualifies for the performance level c (PLc).

#### ■ Failure Detection Signal for EDM1 Signal

The relation of the EDM1, /HWBB1, and /HWBB2 signals is shown below.

Detection of failures in the EDM1 circuit can be checked using the following four status of the EDM1 signal in the table. Failures can be detected if the failure status can be confirmed, e.g., when the power supply is turned ON.

Signal Name	Logic			
/HWBB1	ON	ON	OFF	OFF
/HWBB2	ON	OFF	ON	OFF
EDM1	OFF	OFF	OFF	ON

### WARNING

- The EDM1 signal is not a safety output. Use it only for monitoring a failure.

## (1) Connection Example and Specifications of EDM1 Output Signal

Connection example and specifications of EDM1 output signal are explained below.



**IMPORTANT**

For safety function signal connections, the input signal is the 0 V common and the output signal is the source output. This is opposite to other signals described in this manual. To avoid confusion, the ON and OFF status of signals for safety functions are defined as follows:

**ON:** The state in which the relay contacts are closed or the transistor is ON and current flows into the signal line.

**OFF:** The state in which the relay contacts are open or the transistor is OFF and no current flows into the signal line.

### ■ Connection Example

EDM1 output signal is used for source circuit.

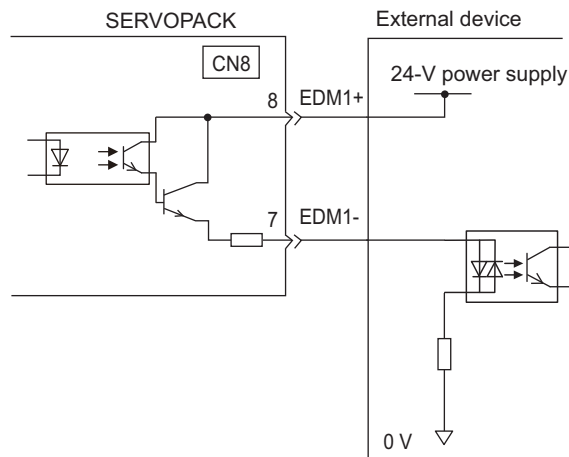

### ■ Specifications

Type	Signal Name	Connector Pin Number	Setting	Meaning
Output	EDM1	CN8-8 CN8-7	ON (closed)	Both the /HWBB1 and the /HWBB2 signals are working normally.
			OFF (open)	The /HWBB1 signal, the /HWBB2 signal or both are not working normally.

Electrical characteristics of EDM1 signal are as follows.

Items	Characteristics	Remarks
Maximum Allowable Voltage	30 VDC	—
Maximum Allowable Current	50 mADC	—
Maximum Voltage Drop at ON	1.0 V	Voltage between EDM1+ and EDM1- when current is 50 mA
Maximum Delay Time	20 ms	Time from the change in /HWBB1 or /HWBB2 until the change in EDM1

### 4.7.3 Application Example of Safety Functions

An example of using safety functions is shown below.

#### (1) Connection Example

In the following example, a safety unit is used and the HWBB function operates when the guard opens.

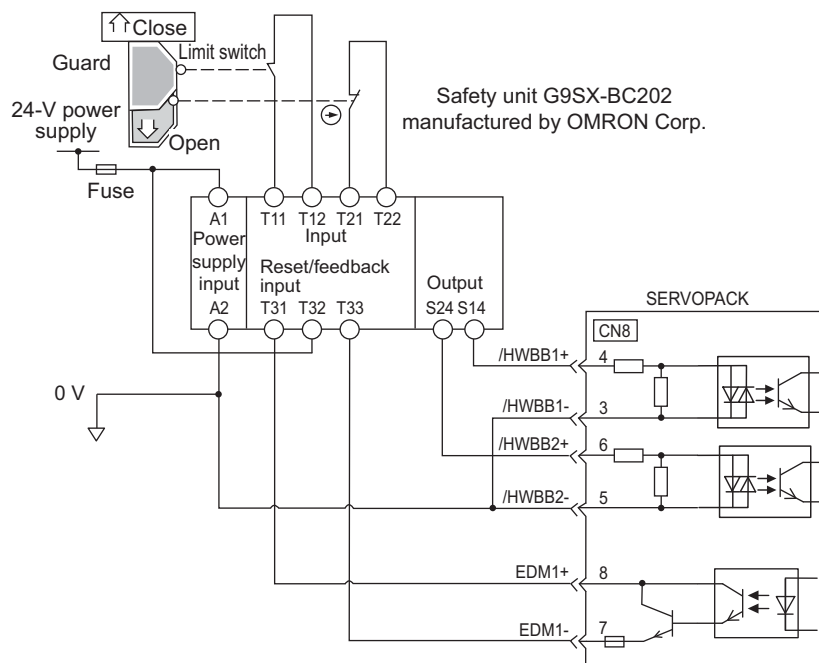

When a guard opens, both of signals, the /HWBB1 and the /HWBB2, turn OFF, and the EDM1 signal turns ON. Since the feedback is ON when the guard closes, the safety unit is reset, and the /HWBB1 and the /HWBB2 signals turn ON, and the operation becomes possible.

Note: The EDM1 signal is used as a sourcing output. Connect the EDM1 so that the current flows from EDM1+ to EDM1-.

#### (2) Failure Detection Method

In case of a failure such as the /HWBB1 or the /HWBB2 signal remains ON, the safety unit is not reset when the guard closes because the EDM1 signal keeps OFF. Therefore starting is impossible, then the failure is detected.

In this case, an error in the external device, disconnection or short-circuiting of the external wiring, or a failure in the SERVOPACK must be considered. Find the cause and correct the problem.

### (3) Procedure

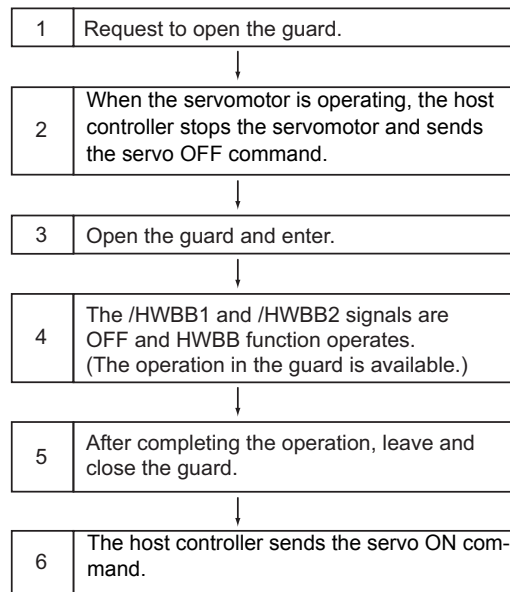

## 4.7.4 Confirming Safety Functions

When starting the equipment or replacing the SERVOPACK for maintenance, be sure to conduct the following confirmation test on the HWBB function after wiring.

- Confirm that the SERVOPACK enters a hard wire base block state and that the servomotor does not operate when the /HWBB1 and /HWBB2 signals are OFF.
- Check the ON/OFF states of the /HWBB1 and /HWBB2 signals with Un015.  
→ If the ON/OFF states of the signals do not coincide with the display, an error in the external device, disconnection or short-circuiting of the external wiring, or a failure in the SERVOPACK must be considered. Find the cause and correct the problem.
- Check with the display of the feedback circuit input of the connected device to confirm that the EDM1 signal is OFF while in normal operation.

### 4.7.5 Safety Device Connections

There are two types of the safety function's jumper connectors that are attached to SERVOPACKs. You must remove a safety function's jumper connector before connecting a safety function device. The connection method depends on the connector type that is used. Read the following procedures well before you attach a safety function device.

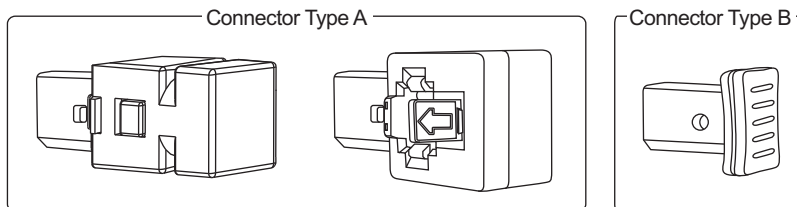

Use the following procedures to attach safety function devices.

#### (1) Connector Type A

1. SGD V-R70F, SGD V-R90F, SGD V-2R1F, SGD V-R70A, SGD V-R90A, SGD V-1R6A, SGD V-2R8A, SGD V-1R9D, SGD V-3R5D, or SGD V-5R4D SERVOPACK  
 Disconnect the servomotor terminal connector while pressing in the servomotor terminal connector lock.

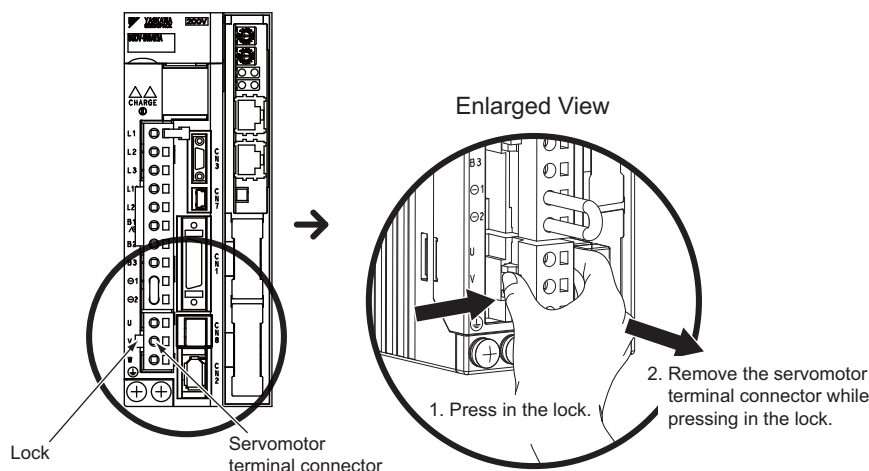

#### When Using Any Other SERVOPACK

It is not necessary to remove the servomotor connection terminals. Proceed to step 2.

2. Slide the lock injector on the safety function's jumper connector toward the SERVOPACK to unlock it and remove the safety function's jumper connector.

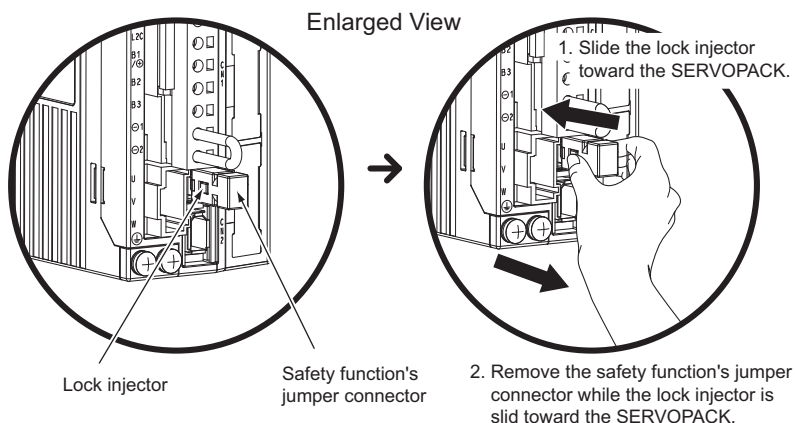

Note: The safety function's jumper connector may be damaged if removed while the lock is still on.

### 3. Connect the safety function device to the safety connector (CN8).

Note: If you do not connect a safety function device, leave the safety function's jumper connector connected to the safety connector (CN8). If the SERVOPACK is used without the safety function's jumper connector connected to CN8, no current will be supplied to the servomotor and no motor force will be output. In this case, the SERVOPACK will enter a hard wire base block state.

## (2) Connector Type B

### 1. Remove the safety function's jumper connector from the safety connector (CN8).

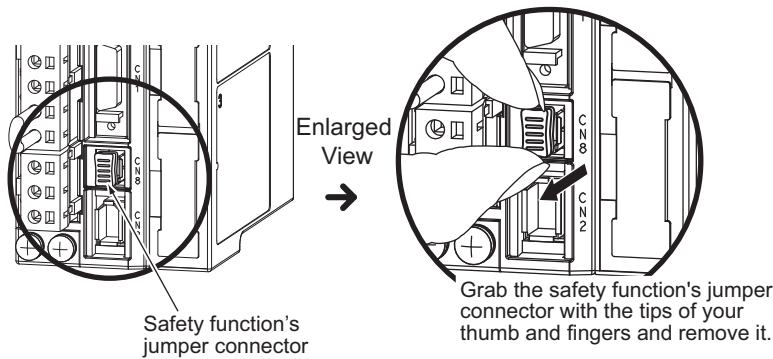

### 2. Connect the safety function device to the safety connector (CN8).

Note: If you do not connect a safety function device, leave the safety function's jumper connector connected to the safety connector (CN8). If the SERVOPACK is used without the safety function's jumper connector connected to CN8, no current will be supplied to the servomotor and no motor force will be output. In this case, the SERVOPACK will enter a hard wire base block state.

## 4.7.6 Precautions for Safety Functions

### ⚠ WARNING

- To check that the HWBB function satisfies the safety requirements of the system, be sure to conduct a risk assessment of the system.  
Incorrect use of the machine may cause injury.
- The servomotor moves if there is external force (e.g., gravity in a vertical axis) when the HWBB function is operating. Therefore, use an appropriate device independently, such as a mechanical brake, that satisfies safety requirements.  
Incorrect use of the machine may cause injury.
- While the HWBB function is operating, the motor may move within an electric angle of 180° or less as a result of a SERVOPACK failure. Use the HWBB function for applications only after checking that the movement of the motor will not result in a dangerous condition.  
Incorrect use of the machine may cause injury.
- The dynamic brake and the brake signal are not safety-related parts of a control system. Be sure to design the system that these failures will not cause a dangerous condition when the HWBB function operates.  
Incorrect use of the machine may cause injury.
- Connect devices meeting safety standards for the signals for safety functions.  
Incorrect use of the machine may cause injury.
- The HWBB function does not shut off the power to the SERVOPACK or electrically isolate it. Take measures to shut off the power to the SERVOPACK when performing maintenance on it.  
Failure to observe this warning may cause an electric shock.

## Adjustments

5.1	Type of Adjustments and Basic Adjustment Procedure	5-3
5.1.1	Adjustments	5-3
5.1.2	Basic Adjustment Procedure	5-4
5.1.3	Monitoring Operation during Adjustment	5-5
5.1.4	Safety Precautions on Adjustment of Servo Gains	5-8
5.2	Tuning-less Function	5-10
5.2.1	Tuning-less Function	5-10
5.2.2	Tuning-less Levels Setting (Fn200) Procedure	5-12
5.2.3	Related Parameters	5-14
5.3	Advanced Autotuning (Fn201)	5-15
5.3.1	Advanced Autotuning	5-15
5.3.2	Advanced Autotuning Procedure	5-18
5.3.3	Related Parameters	5-24
5.4	Advanced Autotuning by Reference (Fn202)	5-25
5.4.1	Advanced Autotuning by Reference	5-25
5.4.2	Advanced Autotuning by Reference Procedure	5-27
5.4.3	Related Parameters	5-31
5.5	One-parameter Tuning (Fn203)	5-32
5.5.1	One-parameter Tuning	5-32
5.5.2	One-parameter Tuning Procedure	5-33
5.5.3	One-parameter Tuning Example	5-39
5.5.4	Related Parameters	5-41
5.6	Anti-Resonance Control Adjustment Function (Fn204)	5-42
5.6.1	Anti-Resonance Control Adjustment Function	5-42
5.6.2	Anti-Resonance Control Adjustment Function Operating Procedure	5-43
5.6.3	Related Parameters	5-47
5.7	Vibration Suppression Function (Fn205)	5-48
5.7.1	Vibration Suppression Function	5-48
5.7.2	Vibration Suppression Function Operating Procedure	5-49
5.7.3	Related Parameters	5-52

<b>5.8 Additional Adjustment Function</b> .....	<b>5-53</b>
5.8.1 Switching Gain Settings .....	5-53
5.8.2 Manual Adjustment of Friction Compensation .....	5-57
5.8.3 Current Control Mode Selection Function .....	5-59
5.8.4 Current Gain Level Setting .....	5-59
5.8.5 Speed Detection Method Selection .....	5-59
<b>5.9 Compatible Adjustment Function</b> .....	<b>5-60</b>
5.9.1 Feedforward Reference .....	5-60
5.9.2 Mode Switch (P/PI Switching) .....	5-61
5.9.3 Force Reference Filter .....	5-63
5.9.4 Position Integral .....	5-65

## 5.1 Type of Adjustments and Basic Adjustment Procedure

This section describes type of adjustments and the basic adjustment procedure.

### 5.1.1 Adjustments

Adjustments (tuning) are performed to optimize the responsiveness of the SERVOPACK.

The responsiveness is determined by the servo gain that is set in the SERVOPACK.

The servo gain is set using a combination of parameters, such as speed loop gain, position loop gain, filters, friction compensation, and mass ratio. These parameters influence each other. Therefore, the servo gain must be set considering the balance between the set values.

Generally, the responsiveness of a machine with high rigidity can be improved by increasing the servo gain. If the servo gain of a machine with low rigidity is increased, however, the machine will vibrate and the responsiveness may not be improved. In such case, it is possible to suppress the vibration with a variety of vibration suppression functions in the SERVOPACK.

The servo gains are factory-set to appropriate values for stable operation. The following utility function can be used to adjust the servo gain to increase the responsiveness of the machine in accordance with the actual conditions. With this function, parameters related to adjustment above will be adjusted automatically and the need to adjust them individually will be eliminated.

This section describes the following utility adjustment functions.

Utility Function for Adjustment	Outline	Applicable Control Method
Tuning-less Levels Setting (Fn200)	This function is enabled when the factory settings are used. This function can be used to obtain a stable response regardless of the type of machine or changes in the load.	Speed and Position
Advanced Autotuning (Fn201)	The following parameters are automatically adjusted using internal references in the SERVOPACK during automatic operation. <ul style="list-style-type: none"> <li>• Mass ratio</li> <li>• Gains (position loop gain, speed loop gain, etc.)</li> <li>• Filters (force reference filter, notch filter)</li> <li>• Friction compensation</li> <li>• Anti-resonance control adjustment function</li> <li>• Vibration suppression function</li> </ul>	Speed and Position
Advanced Autotuning by Reference (Fn202)	The following parameters are automatically adjusted with the position reference input from the host controller while the machine is in operation. <ul style="list-style-type: none"> <li>• Gains (position loop gain, speed loop gain, etc.)</li> <li>• Filters (force reference filter, notch filter)</li> <li>• Friction compensation</li> <li>• Anti-resonance control adjustment function</li> <li>• Vibration suppression function</li> </ul>	Position
One-parameter Tuning (Fn203)	The following parameters are manually adjusted with the position or speed reference input from the host controller while the machine is in operation. <ul style="list-style-type: none"> <li>• Gains (position loop gain, speed loop gain, etc.)</li> <li>• Filters (force reference filter, notch filter)</li> <li>• Friction compensation</li> <li>• Anti-resonance control adjustment function</li> </ul>	Speed and Position
Anti-Resonance Control Adjustment Function (Fn204)	This function effectively suppresses continuous vibration.	Speed and Position
Vibration Suppression Function (Fn205)	This function effectively suppresses residual vibration if it occurs when positioning.	Position

## 5.1.2 Basic Adjustment Procedure

The basic adjustment procedure is shown in the following flowchart. Make suitable adjustments considering the conditions and operating requirements of the machine.

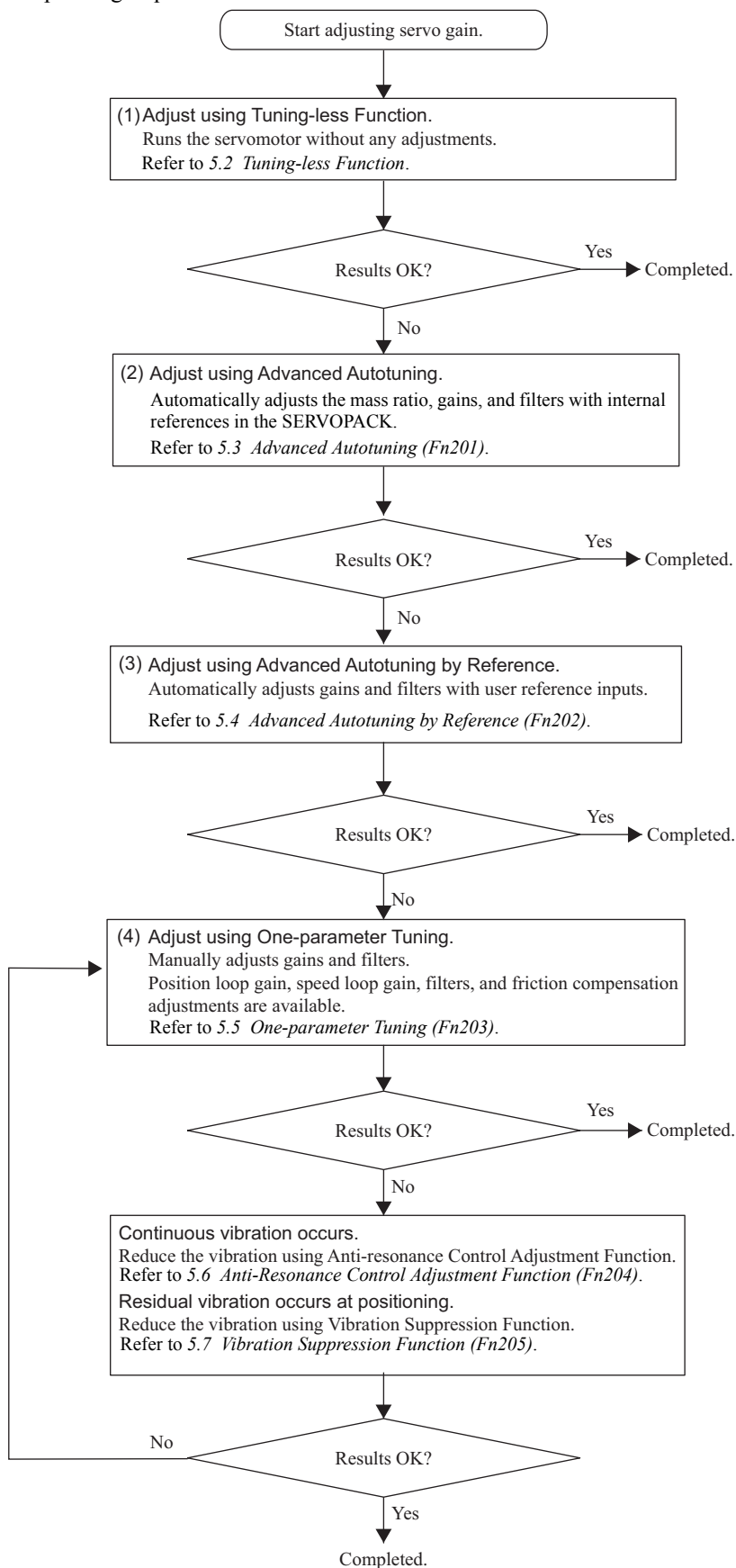

### 5.1.3 Monitoring Operation during Adjustment

Check the operating status of the machine and signal waveform when adjusting the servo gain. Connect a measuring instrument, such as a memory recorder, to connector CN5 analog monitor connector on the SERVOPACK to monitor analog signal waveform.

The settings and parameters for monitoring analog signals are described in the following sections.

#### (1) Connector CN5 for Analog Monitor

To monitor analog signals, connect a measuring instrument to connector CN5 with an analog monitor cable (model: JZSP-CA01-E).

#### ■ Connection Example

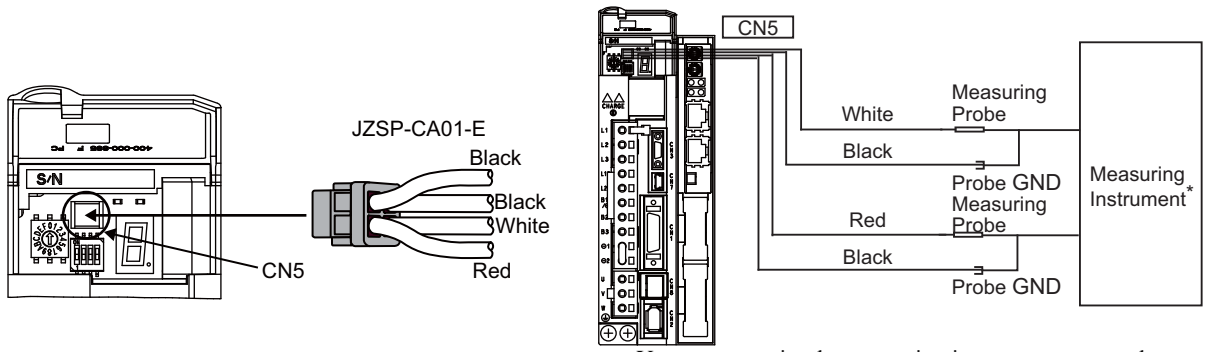

Line Color	Signal Name	Factory Setting
White	Analog monitor 1	Force reference: 1 V/100% rated force
Red	Analog monitor 2	Motor speed: 1 V/1000 mm/s
Black (2 lines)	GND	Analog monitor GND: 0 V

#### (2) Monitor Signal

The shaded parts in the following diagram indicate analog output signals that can be monitored.

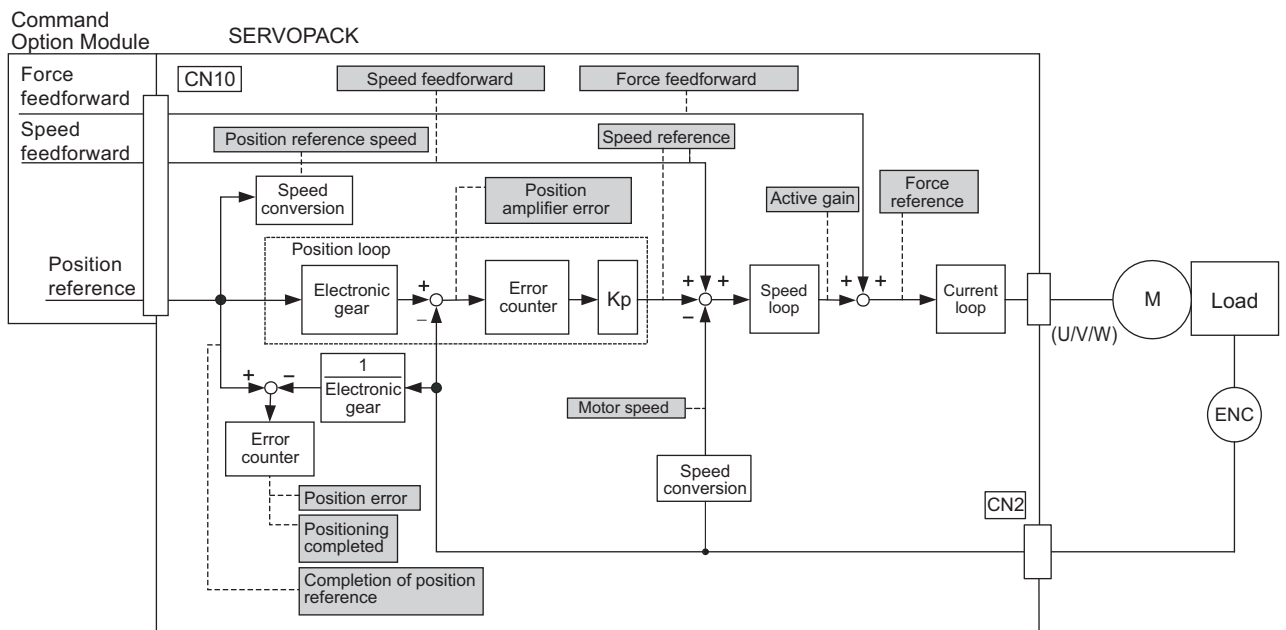

The following signals can be monitored by selecting functions with parameters Pn006 and Pn007. Pn006 is used for analog monitor 1 and Pn007 is used for analog monitor 2.

Parameter		Description		
		Monitor Signal	Unit	Remarks
Pn006 Pn007	n.□□00 [Pn007 Factory Setting]	Motor moving speed	1 V/1000 mm/s	–
	n.□□01	Speed reference	1 V/1000 mm/s	–
	n.□□02 [Pn006 Factory Setting]	Force reference	1 V/100% rated force	–
	n.□□03	Position error	0.05 V/1 reference unit	0 V at speed/force control
	n.□□04	Position amplifier error	0.05 V/1 linear scale pulse unit	Position error after electronic gear conversion
	n.□□05	Position reference speed	1 V/1000 mm/s	–
	n.□□06	Reserved (Do not use.)	–	–
	n.□□07	Reserved (Do not use.)	–	–
	n.□□08	Positioning completed	Positioning completed: 5 V Positioning not completed: 0 V	Completion indicated by output voltage.
	n.□□09	Speed feedforward	1 V/1000 mm/s	–
	n.□□0A	Force feedforward	1 V/100% rated force	–
	n.□□0B	Active gain *	1st gain: 1 V 2nd gain: 2 V	Gain type indicated by output voltage.
	n.□□0C	Completion of position reference	Completed: 5 V Not completed: 0 V	Completion indicated by output voltage.
	n.□□0D	Reserved (Do not use.)	–	–

\* Refer to 5.8.1 *Switching Gain Settings* for details.

### (3) Setting Monitor Factor

The output voltages on analog monitors 1 and 2 are calculated by the following equations.

$$\text{Analog monitor 1 output voltage} = (-1) \times \left( \begin{array}{l} \text{Signal selection} \times \text{Multiplier} + \text{Offset voltage [V]} \\ (\text{Pn006}=\text{n.00}\square\square) \quad (\text{Pn552}) \quad (\text{Pn550}) \end{array} \right)$$

$$\text{Analog monitor 2 output voltage} = (-1) \times \left( \begin{array}{l} \text{Signal selection} \times \text{Multiplier} + \text{Offset voltage [V]} \\ (\text{Pn007}=\text{n.00}\square\square) \quad (\text{Pn553}) \quad (\text{Pn551}) \end{array} \right)$$

<Example>

Analog monitor output at n.□□00 (motor moving speed setting)

When multiplier is set to × 1:

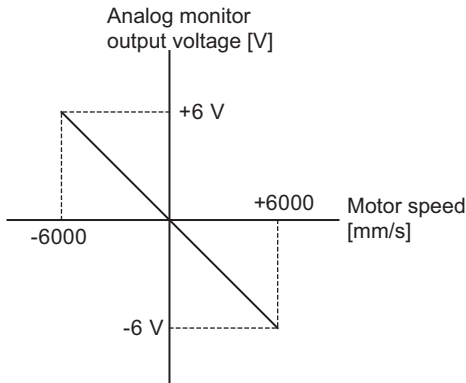

When multiplier is set to × 10:

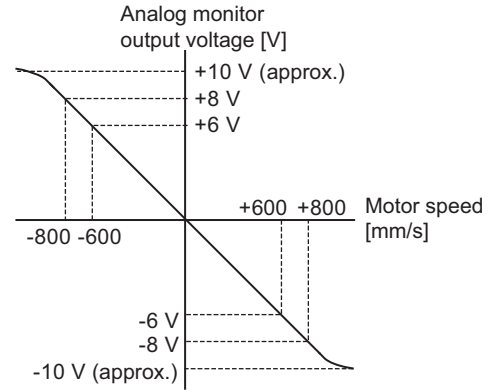

Note: Linear effective range: within ± 8 V  
Output resolution: 16-bit

(4) Related Parameters

Use the following parameters to change the monitor factor and the offset.

Pn550	Analog Monitor 1 Offset Voltage <span style="float:right">Speed Position Force</span>				Classification
	Setting Range	Setting Unit	Factory Setting	When Enabled	
	-10000 to 10000	0.1 V	0	Immediately	Setup
Pn551	Analog Monitor 2 Offset Voltage <span style="float:right">Speed Position Force</span>				Classification
	Setting Range	Setting Unit	Factory Setting	When Enabled	
	-10000 to 10000	0.1 V	0	Immediately	Setup
Pn552	Analog Monitor Magnification (× 1) <span style="float:right">Speed Position Force</span>				Classification
	Setting Range	Setting Unit	Factory Setting	When Enabled	
	-10000 to 10000	× 0.01	100	Immediately	Setup
Pn553	Analog Monitor Magnification (× 2) <span style="float:right">Speed Position Force</span>				Classification
	Setting Range	Setting Unit	Factory Setting	When Enabled	
	-10000 to 10000	× 0.01	100	Immediately	Setup

### 5.1.4 Safety Precautions on Adjustment of Servo Gains



#### CAUTION

- If adjusting the servo gains, observe the following precautions.
  - Do not touch the moving section of the servomotor while power is being supplied to the motor.
  - Before starting the servomotor, make sure that the SERVOPACK can come to an emergency stop at any time.
  - Make sure that a trial operation has been performed without any trouble.
  - Install a safety brake on the machine.

Set the following protective functions of the SERVOPACK to suitable settings before you start to adjust the servo gains.

#### (1) Overtravel Function

Set the overtravel function. For details on how to set the overtravel function, refer to 4.2.3 *Overtravel*.

#### (2) Force Limit

The force limit calculates the force required to operate the machine and sets the force limits so that the output force will not be greater than required. Setting force limits can reduce the amount of shock applied to the machine when troubles occur, such as collisions or interference. If a force limit is set lower than the value that is needed for operation, overshooting or vibration can be occurred.

For details, refer to 4.4 *Limiting Force*.

#### (3) Excessive Position Error Alarm Level

The excessive position error alarm is a protective function that will be enabled when the SERVOPACK is used in position control.

If this alarm level is set to a suitable value, the SERVOPACK will detect an excessive position error and will stop the servomotor if the servomotor does not operate according to the reference. The position error indicates the difference between the position reference value and the actual motor position.

The position error can be calculated from the position loop gain (Pn102) and the motor speed with the following equation.

$$\text{Position Error [reference unit]} = \frac{\text{Motor Speed [mm/s]}}{\text{Pn102 [0.1/s]/10}^{*1, *2}} \times \frac{\text{Number of Divisions}}{\text{Linear Scale Pitch [\mu m]/1000}} \times \frac{\text{Pn210}}{\text{Pn20E}}$$

- Excessive Position Error Alarm Level (Pn520 [1 reference unit])

$$\text{Pn520} > \frac{\text{Max. Motor Speed [mm/s]}}{\text{Pn102 [0.1/s]/10}^{*1, *2}} \times \frac{\text{Number of Divisions}}{\text{Linear Scale Pitch [\mu m]/1000}} \times \frac{\text{Pn210}}{\text{Pn20E}} \times \underline{(1.2 \text{ to } 2)}^{*3}$$

\*1. When model following control is enabled (Pn140 = n.□□□1), use the set value in Pn141 and not in Pn102.

\*2. To check the setting in Pn102, change the parameter display setting to display all parameters (Pn00B = n.□□□1).

\*3. The underlined “(1.2 to 2)” portion is a factor that creates a margin so that a position error overflow alarm (A.d00) does not frequently occur.

Set the level to a value that satisfies these equations, and no position error overflow alarm (A.d00) will be generated during normal operation.

The servomotor will be stopped, however, if it does not operate according to the reference and the SERVOPACK detects an excessive position error.

If the acceleration/deceleration of the position reference exceeds the capacity of the servomotor, the servomotor cannot perform at the requested speed, and the allowable level for position error will be increased as not to satisfy these equations. If so, lower the level of the acceleration/deceleration for the position reference so that the servomotor can perform at the requested speed or increase the excessive position error alarm level (Pn520).

### ■ Related Parameter

Pn520	Excessive Position Error Alarm Level <span style="float: right;">Position</span>				Classification
	Setting Range	Setting Unit	Factory Setting	When Enabled	
	1 to 1073741823	1 reference unit	5242880	Immediately	Setup

### ■ Related Alarm

Alarm Display	Alarm Name	Meaning
A.d00	Position Error Overflow	Position errors exceeded parameter Pn520.

## (4) Vibration Detection Function

Set the vibration detection function to an appropriate value with the vibration detection level initialization (Fn01B). For details on how to set the vibration detection function, refer to 6.16 *Vibration Detection Level Initialization (Fn01B)*.

## (5) Excessive Position Error Alarm Level at Servo ON

If position errors remain in the error counter when turning ON the servomotor power, the servomotor will move and this movement will clear the counter of all position errors. Because the servomotor will move suddenly and unexpectedly, safety precautions are required. To prevent the servomotor from moving suddenly, select the appropriate level for the excessive position error alarm level at servo ON (Pn526) to restrict operation of the servomotor.

### ■ Related Parameters

Pn526	Excessive Position Error Alarm Level at Servo ON <span style="float: right;">Position</span>				Classification
	Setting Range	Setting Unit	Factory Setting	When Enabled	
	1 to 1073741823	1 reference unit	5242880	Immediately	Setup

Pn528	Excessive Position Error Warning Level at Servo ON <span style="float: right;">Position</span>				Classification
	Setting Range	Setting Unit	Factory Setting	When Enabled	
	10 to 100	1%	100	Immediately	Setup

Pn584	Speed Limit Level at Servo ON <span style="float: right;">Position</span>				Classification
	Setting Range	Setting Unit	Factory Setting	When Enabled	
	0 to 10000	1 mm/s	10000	Immediately	Setup

### ■ Related Alarms

Alarm Display	Alarm Name	Meaning
A.d01	Position Error Overflow Alarm at Servo ON	This alarm occurs if the servomotor power is turned ON when the position error is greater than the set value of Pn526 while the servomotor power is OFF.
A.d02	Position Error Overflow Alarm by Speed Limit at Servo ON	When the position errors remain in the error counter, Pn584 limits the speed if the servomotor power is turned ON. If Pn584 limits the speed in such a state, this alarm occurs when position references are input and the number of position errors exceeds the value set for the excessive position error alarm level (Pn520).

When an alarm occurs, refer to 8 *Troubleshooting* and take the corrective actions.

## 5.2 Tuning-less Function

The tuning-less function is enabled in the factory settings. If resonance is generated or excessive vibration occurs, refer to 5.2.2 *Tuning-less Levels Setting (Fn200) Procedure* and change the set value of Pn170.2 for the rigidity level and the set value in Pn170.3 for the load level.

### CAUTION

- The tuning-less function is enabled in the factory settings. A sound may be heard for a moment when the servo ON command is received for the first time after the servo drive is mounted to the machine. This sound does not indicate any problems; it means that the automatic notch filter was set. The sound will not be heard from the next time the servo ON command is received. For details on the automatic notch filter, refer to (3) *Automatically Setting the Notch Filter* on the next page.
- The servomotor may vibrate if the mass of the load is 30 times greater or more than that of the servomotor in the mass ratio.  
If vibration occurs, set the mode to 2 in Fn200 or lower the adjustment level.

### 5.2.1 Tuning-less Function

The tuning-less function obtains a stable response without manual adjustment regardless of the type of machine or changes in the load.

#### (1) Enabling/Disabling Tuning-less Function

The following parameter is used to enable or disable the tuning-less function.

Parameter	Meaning	When Enabled	Classification
Pn170	n.□□□0	Disables tuning-less function.	After restart Setup
	n.□□□1 [Factory setting]	Enables tuning-less function.	
	n.□□0□ [Factory setting]	Used as speed control.	
	n.□□1□	Used as speed control and host controller used as position control.	

#### (2) Application Restrictions

The tuning-less function can be used in position control or speed control. This function is not available in force control. The following application restrictions apply to the tuning-less function.

Function	Availability	Remarks
Vibration detection level initialization (Fn01B)	Available	–
Advanced autotuning (Fn201)	Available (Some conditions apply)	<ul style="list-style-type: none"> <li>• Execute this function when mass (Jcalc = ON) is set.</li> <li>• The tuning-less function is disabled while Fn201 is being executed. It remains disabled after Fn201 is completed.</li> </ul>
Advanced autotuning by reference (Fn202)	Not available	–
One-parameter tuning (Fn203)	Not available	–
Anti-resonance control adjustment function (Fn204)	Not available	–
Vibration suppression function (Fn205)	Not available	–
EasyFFT (Fn206)	Available	While this function is being used, the tuning-less function cannot be used. After completion of the EasyFFT, it can be used again.
Friction compensation	Not available	–
Gain switching	Not available	–

(cont'd)

Function	Availability	Remarks
Offline mass calculation *	Not available	Disable the tuning-less function by setting Pn170.0 to 0 before executing this function.
Mechanical analysis*	Available	While this function is being used, the tuning-less function cannot be used. After completion of the analysis, it can be used again.

\* Operate using SigmaWin+.

### (3) Automatically Setting the Notch Filter

Usually, set this function to Auto Setting. (The notch filter is factory-set to Auto Setting.)

If this function is set to Auto Setting, vibration will be detected automatically and the notch filter will be set when the tuning-less function is enabled.

Set this function to Not Auto Setting only if you do not change the notch filter setting before executing tuning-less function.

Parameter		Meaning	When Enabled	Classification
<b>Pn460</b>	n.□0□□	Does not set the 2nd notch filter automatically with utility function.	Immediately	Tuning
	n.□1□□ [Factory setting]	Set the 2nd notch filter automatically with utility function.		



**IMPORTANT**

Always set Pn460.2 to 0 in the following cases.

- Mechanism that produces a large disturbance (such as guides)
- When using force limits
- When the speed references are step inputs

If you set Pn460.2 to 1, vibration detection may not operate effectively.

### (4) Tuning-less Level Settings

Two tuning-less levels are available: the rigidity level and load level. Both levels can be set in the Fn200 utility function or in the Pn170 parameter.

#### ■ Rigidity Level

##### a) Using the utility function

To change the setting, refer to 5.2.2 *Tuning-less Levels Setting (Fn200) Procedure*.

Digital Operator Display	Meaning
Level 0	Rigidity level 0
Level 1	Rigidity level 1
Level 2	Rigidity level 2
Level 3	Rigidity level 3
Level 4 [Factory setting]	Rigidity level 4

##### b) Using the parameter

Parameter		Meaning	When Enabled	Classification
<b>Pn170</b>	n.□0□□	Rigidity level 0 (Level 0)	Immediately	Setup
	n.□1□□	Rigidity level 1 (Level 1)		
	n.□2□□	Rigidity level 2 (Level 2)		
	n.□3□□	Rigidity level 3 (Level 3)		
	n.□4□□ [Factory setting]	Rigidity level 4 (Level 4)		

### ■ Load Level

#### a) Using the utility function

To change the setting, refer to 5.2.2 *Tuning-less Levels Setting (Fn200) Procedure*.

Digital Operator Display	Meaning
Mode 0	Load level: Low
Mode 1 [Factory setting]	Load level: Medium
Mode 2	Load level: High

#### b) Using the parameter

Parameter	Meaning	When Enabled	Classification
Pn170	n.0□□□	Load level: Low (Mode 0)	Immediately Setup
	n.1□□□ [Factory setting]	Load level: Medium (Mode 1)	
	n.2□□□	Load level: High (Mode 2)	

## 5.2.2 Tuning-less Levels Setting (Fn200) Procedure

### ⚠ CAUTION

- To ensure safety, perform the tuning-less function in a state where the SERVOPACK can come to an emergency stop at any time.

The procedure to use the tuning-less function is given below.

Operate the tuning-less function from the digital operator (option) or SigmaWin+.













For the basic operation of the digital operator, refer to *Σ-V Series User's Manual, Operation of Digital Operator* (No.: SIEP S80000 55).

### (1) Preparation











Check the following settings before performing the tuning-less function. If the settings are not correct, "NO-OP" will be displayed during the tuning-less function.

- The tuning-less function must be enabled (Pn170.0 = 1).
- The write prohibited setting (Fn010) must be set to Write permitted (P.0000).
- The test without a motor function must be disabled. (Pn00C.0 = 0).

### (2) Operating Procedure with Digital Operator

Step	Display after Operation	Keys	Operation
1	<pre> RUN  -FUNCTION- Fn080: Pole Detect Fn200: TuneLvl Set Fn201: AAT Fn202: Ref-AAT           </pre>	  	<p>Press the  Key to view the main menu for the utility function.</p> <p>Use the  or  Key to move through the list, select Fn200.</p>
2	<pre> RUN  -TuneLvlSet- Mode=1           </pre>		<p>Press the  key to display the load level setting screen for Fn200 (Tuning-less Levels Setting).</p> <p>Notes:</p> <ul style="list-style-type: none"> <li>• If the response waveform causes overshooting or if the mass of the load is 30 times greater or more than that of the servomotor in the mass ratio (i.e., outside the scope of product guarantee), press the  Key and change the mode setting to 2.</li> <li>• If a high-frequency noise is heard, press the  Key and change the mode setting to 0.</li> </ul>
3	<pre> RUN  -TuneLvlSet- Level=4           </pre>		<p>Press the  Key to display the rigidity level of the tuning-less mode setting screen.</p>

(cont'd)

Step	Display after Operation	Keys	Operation
4	<pre> RUN  -TuneLvISet- Level = 4 NF 2       ↑       2nd notch filter           </pre>	  	<p>Press the  Key or the  Key to select the rigidity level.</p> <p>Select the rigidity level from 0 to 4. The larger the value, the higher the gain is and the better response performance will be. (The factory setting is 4.)</p> <p>Notes:</p> <ul style="list-style-type: none"> <li>• Vibration may occur if the rigidity level is too high. Lower the rigidity level if vibration occurs.</li> <li>• If a high-frequency noise is heard, press the  Key to automatically set a notch filter to the vibration frequency.</li> </ul>
5	<pre> RUN  -TuneLvISet- Level = 4           </pre>		<p>Press the  Key. “DONE” will flash for approximately two seconds and then “RUN” will be displayed. The settings are saved in the SERVOPACK.</p>
6	<pre> RUN  -FUNCTION- Fn030 Fn200 Fn201 Fn202           </pre>		<p>Press the  Key to complete the tuning-less function. The screen in step 1 will appear again.</p>

Note: If the rigidity level is changed, the automatically set notch filter will be canceled. If vibration occurs, however, the notch filter will be set again automatically.

### (3) Alarm and Corrective Actions

The autotuning alarm (A.521) will occur if resonance sound is generated or excessive vibration occurs during position control. In such case, take the following actions.

#### ■ Resonance Sound

Reduce the setting of the rigidity level or load level.

#### ■ Excessive Vibration during Position Control

Take one of the following actions to correct the problem.

- Increase the setting of the rigidity level or reduce the load level.
- Increase the setting of Pn170.3 or reduce the setting of Pn170.2.

#### (4) Parameters Disabled by Tuning-less Function

When the tuning-less function is enabled in the factory settings, the settings of these parameters are not available: Pn100, Pn101, Pn102, Pn103, Pn104, Pn105, Pn106, Pn160, Pn139, and Pn408. These gain-related parameters, however, may become effective depending on the executing conditions of the functions specified in the following table. For example, if EasyFFT is executed when the tuning-less function is enabled, the settings in Pn100, Pn104, Pn101, Pn105, Pn102, Pn106, and Pn103, as well as the manual gain switch setting, will be enabled, but the settings in Pn408.3, Pn160.0, and Pn139.0 will be not enabled.

Parameters Disabled by Tuning-less Function			Related Functions and Parameters*		
Item	Name	Pn Number	Force Control	Easy FFT	Mechanical Analysis (Vertical Axis Mode)
Gain	Speed Loop Gain 2nd Speed Loop Gain	Pn100 Pn104	○	○	○
	Speed Loop Integral Time Constant 2nd Speed Loop Integral Time Constant	Pn101 Pn105	×	○	○
	Position Loop Gain 2nd Position Loop Gain	Pn102 Pn106	×	○	○
	Mass Ratio	Pn103	○	○	○
Advanced Control	Friction Compensation Function Selection	Pn408.3	×	×	×
	Anti-resonance Control Adjustment Selection	Pn160.0	×	×	×
Gain Switching	Gain Switching Selection Switch	Pn139.0	×	×	×

\* ○: Parameter enabled  
×: Parameter disabled

### 5.2.3 Related Parameters

The following table lists parameters related to this function and their possibility of being changed while executing this function or of being changed automatically after executing this function.

- Parameters related to this function  
These are parameters that are used or referenced when executing this function.
- Allowed changes during execution of this function  
Yes : Parameters can be changed using SigmaWin+ while this function is being executed.  
No : Parameters cannot be changed using SigmaWin+ while this function is being executed.
- Automatic changes after execution of this function  
Yes : Parameter set values are automatically set or adjusted after execution of this function.  
No : Parameter set values are not automatically set or adjusted after execution of this function.

Parameter	Name	Mid-execution changes	Automatic changes
<b>Pn170</b>	Tuning-less Function Related Switch	No	Yes
<b>Pn401</b>	Force Reference Filter Time Constant	No	Yes
<b>Pn40C</b>	2nd Notch Filter Frequency	No	Yes
<b>Pn40D</b>	2nd Notch Filter Q Value	No	Yes

## 5.3 Advanced Autotuning (Fn201)

This section describes the adjustment using advanced autotuning.



### IMPORTANT

- Advanced autotuning starts adjustments based on the set speed loop gain (Pn100). Therefore, precise adjustments cannot be made if there is vibration when starting adjustments. In this case, make adjustments after lowering the speed loop gain (Pn100) until vibration is eliminated.
- Before performing advanced autotuning with the tuning-less function enabled (Pn170.0 = 1: Factory setting), always set Jcalc to ON to calculate the mass. The tuning-less function will automatically be disabled, and the gain will be set by advanced autotuning.  
With Jcalc set to OFF so the mass is not calculated, "Error" will be displayed on the panel operator, and advanced autotuning will not be performed.
- If the operating conditions, such as the machine-load or drive system, are changed after advanced autotuning, then change the following related parameters to disable any values that were adjusted before performing advanced autotuning once again with the setting to calculate the mass (Jcalc = ON). If advanced autotuning is performed without changing the parameters, machine vibration may occur, resulting in damage to the machine.
  - Pn00B.0=1 (Displays all parameters.)
  - Pn140.0=0 (Does not use model following control.)
  - Pn160.0=0 (Does not use anti-resonance control.)
  - Pn408=n.00□0 (Does not use friction compensation, 1st notch filter, or 2nd notch filter.)

### 5.3.1 Advanced Autotuning

Advanced autotuning automatically operates the servo system (in reciprocating movement in the forward and reverse directions) within set limits and adjust the SERVOPACK automatically according to the mechanical characteristics while the servo system is operating.

Advanced autotuning can be performed without connecting the host controller. The following automatic operation specifications apply.

- Maximum speed: Rated motor speed  $\times 2/3$
- Acceleration force: Approximately 100% of rated motor force  
The acceleration force varies with the influence of the mass ratio (Pn103), machine friction, and external disturbance.
- Travel distance: Set in unit of 1000 reference unit. Factory setting is 90 mm.

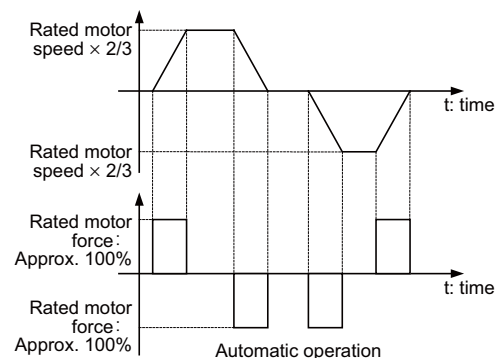
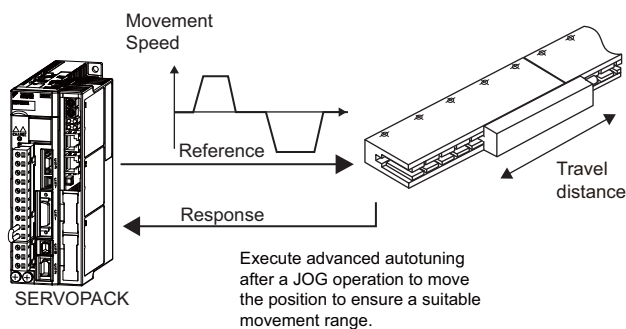

Advanced autotuning performs the following adjustments.

- Mass ratio
- Gains (e.g., position loop gain and speed loop gain)
- Filters (force reference filter and notch filter)
- Friction compensation

- Anti-resonance control
- Vibration suppression (Mode = 2 or 3)

Refer to 5.3.3 *Related Parameters* for parameters used for adjustments.



## CAUTION

- Because advanced autotuning adjusts the SERVOPACK during automatic operation, vibration or overshooting may occur. To ensure safety, perform advanced autotuning in a state where the SERVOPACK can come to an emergency stop at any time.

### (1) Preparation

Check the following settings before performing advanced autotuning.

The message “NO-OP” indicating that the settings are not appropriate will be displayed, if all of the following conditions are not met.

- The main circuit power supply must be ON.
- There must be no overtravel.
- The servomotor power must be OFF.
- The control method must not be set to force control.
- The gain selection switch must be in manual switching mode (Pn139.0 = 0).
- Gain setting 1 must be selected.
- The test without a motor function must be disabled (Pn00C.0 = 0).
- All alarms and warning must be cleared.
- The hardwire baseblock (HWBB) must be disabled.
- The write prohibited setting (Fn010) must be set to Write permitted (P.0000).
- Jcalc must be set to ON to calculate the mass when the tuning-less function is enabled (Pn170.0 = 1: factory setting) or the tuning-less function must be disabled (Pn170.0 = 0).

Note:

If advanced autotuning is started while the SERVOPACK is in speed control, the mode will change to position control automatically to perform advanced autotuning. The mode will return to speed control after completing the adjustment. To perform advanced autotuning in speed control, set the mode to 1 (Mode = 1).

### (2) When Advanced Autotuning Cannot Be Performed

Advanced autotuning cannot be performed normally under the following conditions. Refer to 5.4 *Advanced Autotuning by Reference (Fn202)* and 5.5 *One-parameter Tuning (Fn203)* for details.

- The machine system can work only in a single direction.
- The operating range is 5 mm or less.

### (3) When Advanced Autotuning Cannot Be Performed Successfully

Advanced autotuning cannot be performed successfully under the following conditions. Refer to 5.4 *Advanced Autotuning by Reference (Fn202)* and 5.5 *One-parameter Tuning (Fn203)* for details.

- The operating range is not applicable.
- The mass changes within the set operating range.
- The machine has high friction.
- The rigidity of the machine is low and vibration occurs when positioning is performed.
- The position integration function is used.
- P control operation (proportional control) is used.

Note: If a setting is made for calculating the mass, an error will result when P control operation is selected while the mass is being calculated.

- The mode switch is used.

Note: If a setting is made for calculating the mass, the mode switch function will be disabled while the mass is being calculated. At that time, PI control will be used. The mode switch function will be enabled after calculating the mass.

- Speed feedforward or force feedforward is input.
- The positioning completed width (Pn522) is too small.

**IMPORTANT**

- Advanced autotuning makes adjustments by referring to the positioning completed width (Pn522). If the SERVOPACK is operated in position control (Pn000.1=1), set the electronic gear ratio (Pn20E/Pn210) and positioning completed width (Pn522) to the actual value during operation. If the SERVOPACK is operated in speed control (Pn000.1=0), set Mode to 1 to perform advanced autotuning.
- Unless the positioning completed signal (/COIN) is turned ON within approximately 3 seconds after positioning has been completed, "WAITING" will flash. Furthermore, unless the positioning completed signal (/COIN) is turned ON within approximately 10 seconds, "Error" will flash for 2 seconds and tuning will be aborted.

Change only the overshoot detection level (Pn561) to finely adjust the amount of overshooting without changing the positioning completed width (Pn522). Because Pn561 is set by default to 100%, the allowable amount of overshooting is the same amount as that for the positioning completed width.

When Pn561 is set to 0%, the amount of overshooting can be adjusted to prevent overshooting the positioning completed width. If the setting of Pn561 is changed, however, the positioning time may be extended.

Pn561	Overshoot Detection Level			Speed	Position	Force	Classification
	Setting Range	Setting Unit	Factory Setting	When Enabled			
	0 to 100	1%	100	Immediately		Setup	

### 5.3.2 Advanced Autotuning Procedure

The following procedure is used for advanced autotuning.

Advanced autotuning is performed from the digital operator (option) or SigmaWin+.















The operating procedure from the digital operator is described here.

Refer to the *S-V Series User's Manual, Operation of Digital Operator* (No.: SIEP S800000 55) for basic key operations of the digital operator.

















#### ⚠ CAUTION

- When using the SERVOPACK with Jcalc = OFF (mass is not calculated), be sure to set a suitable value for the mass ratio (Pn103). If the setting greatly differs from the actual mass ratio, normal control of the SERVOPACK may not be possible, and vibration may result.



#### (1) Operating Procedure

Step	Display after Operation	Keys	Operation
1	<pre> BB      — FUNCTION — Fn200: TuneLvl Set Fn201: AAT Fn202: Ref-AAT Fn203: OnePrmTun           </pre>	  	Press the  Key to view the main menu for the utility function. Use the  or  Key to move through the list, select Fn201.
2	<pre> BB      Advanced AT Jcalc=ON Mode=2 Type=2 Stroke=+00800000 (0003.0) rev           </pre>		Press the  Key to display the initial setting screen for F201 (Advanced Autotuning).
3	<pre> BB      Advanced AT Jcalc=ON Mode=2 Type=2 Stroke=+00800000 (0003.0) rev           </pre>	  	Press the  ,  , or  Key and set the items in steps 3-1 to 3-4.
3-1	<p>■ Calculating Mass</p> <p>Select the mode to be used.            Usually, set Jcalc to ON.            Jcalc = ON: Mass calculated [Factory setting]            Jcalc = OFF: Mass not calculated            Note: If the mass ratio is already known from the machine specifications, set the value in Pn103 and set Jcalc to OFF.</p>		
3-2	<p>■ Mode Selection</p> <p>Select the mode.            Mode = 1: Makes adjustments considering response characteristics and stability (Standard level).            Mode = 2: Makes adjustments for positioning [Factory setting].            Mode = 3: Makes adjustments for positioning, giving priority to overshooting suppression.</p>		
3-3	<p>■ Type Selection</p> <p>Select the type according to the machine element to be driven. If there is noise or the gain does not increase, better results may be obtained by changing the rigidity type.            Type = 1: Low rigidity            Type = 2: Medium rigidity [Factory setting]            Type = 3: High rigidity</p>		

(cont'd)

Step	Display after Operation	Keys	Operation
3-4	<p>■STROKE (Travel Distance) Setting</p> <p>Travel distance setting range: The travel distance setting range is from -99990000 to +99990000 [reference unit]. Specify the STROKE (travel distance) in increments of 1000 reference units. The negative (-) direction is for reverse movement, and the positive (+) direction is for forward movement.</p> <p>Initial value: About 90 mm</p> <p>Notes:</p> <ul style="list-style-type: none"> <li>Set the travel distance to at least 5 mm; otherwise, "Error" will be displayed and the travel distance cannot be set.</li> <li>To calculate the mass and ensure precise tuning, it is recommended to set the travel distance to about 90 mm.</li> </ul>		
4	<pre>BB      Advanced AT Pn103=00100 Pn100=0040.0 Pn101=0020.00 Pn102=0040.0</pre>		Press the  Key. The advanced autotuning execution screen will be displayed.
5	<pre>RUN     Advanced AT Pn103=00100 Pn100=0040.0 Pn101=0020.00 Pn141=0050.0</pre>		Press the  Key. The servomotor power will be ON and the display will change from "BB" to "RUN." Note: If the mode is set to 1, Pn102 is displayed. If the mode is set to 2 or 3, the Pn102 display will change to the Pn141.
6	<pre>ADJ     Advanced AT Pn103=00300 Pn100=0040.0 Pn101=0020.0 Pn141=0050.0</pre> <p>Display example: After the mass is calculated.</p>	 	Calculates the mass. Press the  Key if a positive (+) value is set in STROKE (travel distance), or press the  Key if a negative (-) value is set. Calculation of the mass will start. While the mass is being calculated, the set value for Pn103 will flash and "ADJ" will flash instead of "RUN." When calculating the mass is completed, the display will stop flashing and the mass is displayed. The servomotor will remain ON, but the auto run operation will be stopped temporarily. Notes: <ul style="list-style-type: none"> <li>The wrong key for the set travel direction is pressed, the calculation will not start.</li> <li>If the mass is not calculated (Jcalc = OFF), the set value for Pn103 will be displayed.</li> <li>If "NO-OP" or "Error" is displayed during operation, press the  Key to cancel the function. Refer to (2) <i>Failure in Operation</i> and take a corrective action to enable operation.</li> </ul>
7	—	 	After the servomotor is temporarily stopped, press the  Key to save the calculated mass ratio in the SERVOPACK. "DONE" will flash for one second, and "ADJ" will be displayed again. Note: To end operation by calculating only the mass ratio and without adjusting the gain, press the  Key to end operation.
8	<pre>ADJ     Advanced AT Pn103=00300 Pn100=0100.0 Pn101=0006.36 Pn141=0150.0</pre>	 	<p>■Gain Adjustment</p> <p>When the  or  Key is pressed according to the sign (+ or -) of the value set for stroke (travel distance), the calculated value of the mass ratio will be saved in the SERVOPACK and the auto run operation will restart. While the servomotor is running, the filters, and gains will be automatically set. "ADJ" will flash during the auto setting operation. Note: Precise adjustments cannot be made and "Error" will be displayed as the status if there is machine resonance when starting adjustments. If that occurs, make adjustments using one-parameter tuning (Fn203).</p>

(cont'd)

Step	Display after Operation	Keys	Operation
9	<pre> ADJ   Advanced   AT Pn 103=00300 Pn 100=0100.0 Pn 101=0006.36 Pn 141=0150.0                     </pre>	—	When the adjustment has been completed normally, the servomotor power will turn OFF, and "END" will flash for approximately two seconds and then "ADJ" will be displayed on the status display.
10	<pre> BB   Advanced   AT Pn 103=00300 Pn 100=0100.0 Pn 101=0006.36 Pn 141=0150.0                     </pre>	<div style="border: 1px solid black; padding: 2px; display: inline-block;">DATA</div>	Press the  Key. The adjusted values will be saved in the SERVOPACK. "DONE" will flash for approximately two seconds, and "BB" will be displayed. Note: Press the  Key to not save the values. The display will return to that shown in step 1.
11	Turn ON the SERVOPACK power supply again after executing advanced autotuning.		

(2) Failure in Operation

■ When "NO-OP" Flashes on the Display

Probable Cause	Corrective Actions
The main circuit power supply was OFF.	Turn ON the main circuit power supply.
An alarm or warning occurred.	Remove the cause of the alarm or the warning.
Overtraveling occurred.	Remove the cause of the overtravel.
Gain setting 2 was selected by gain switching.	Disable the automatic gain switching.
The HWBB function operated.	Disable the HWBB function.

### ■ When "Error" Flashes on the Display

Error	Probable Cause	Corrective Actions
The gain adjustment was not successfully completed.	Machine vibration is occurring or the positioning completed signal (/COIN) is turning ON and OFF when the servomotor is stopped.	<ul style="list-style-type: none"> <li>• Increase the set value for Pn522.</li> <li>• Change the mode from 2 to 3.</li> <li>• If machine vibration occurs, suppress the vibration with the anti-resonance control adjustment function and the vibration suppression function.</li> </ul>
An error occurred during the calculation of the mass.	Refer to 5.3.2 (2) ■ <i>When an Error Occurs during Calculation of Mass.</i>	
Travel distance setting error	The travel distance is set to approximately 5 mm or less, which is less than the minimum adjustable travel distance.	Increase the travel distance. It is recommended to set the travel distance to 90 mm.
The positioning completed signal (/COIN) did not turn ON within approximately 10 seconds after positioning adjustment was completed.	The positioning completed width is too narrow or proportional control (P control) is being used.	<ul style="list-style-type: none"> <li>• Increase the set value for Pn522.</li> <li>• Clear the P control action setting.</li> </ul>
The mass cannot be calculated when the tuning-less function was activated.	When the tuning-less function was activated, Jcalc was set to OFF so the mass was not calculated.	<ul style="list-style-type: none"> <li>• Turn OFF the tuning-less function.</li> <li>• Set Jcalc to ON, so the mass will be calculated.</li> </ul>

### ■ When an Error Occurs during Calculation of Mass

The following table shows the probable causes of errors that may occur during the calculation of the mass with the Jcalc set to ON, along with corrective actions for the errors.

Error Display	Probable Cause	Corrective Actions
Err1	The SERVOPACK started calculating the mass, but the calculation was not completed.	<ul style="list-style-type: none"> <li>• Increase the speed loop gain (Pn100).</li> <li>• Increase the STROKE (travel distance).</li> </ul>
Err2	The mass fluctuated greatly and did not converge within 10 tries.	Set the calculation value based on the machine specifications in Pn103 and execute the calculation with the Jcalc set to OFF.
Err3	Low-frequency vibration was detected.	Double the set value of the mass calculating start level (Pn324).
Err4	The force limit was reached.	<ul style="list-style-type: none"> <li>• When using the force limit, increase the force limit.</li> <li>• Double the set value of the mass calculating start level (Pn324).</li> </ul>
Err5	While calculating the mass, the speed control was set to proportional control.	Operate the SERVOPACK with PI control while calculating the mass.

### (3) Related Functions on Advanced Autotuning

This section describes functions related to advanced tuning.

#### ■ Notch Filter

Usually, set this function to Auto Setting. (The notch filter is factory-set to Auto Setting.)

If this function is set to Auto Setting, vibration will be detected automatically during advanced autotuning and the notch filter will be set.

Set this function to Not Auto Setting only if you do not change the notch filter setting before executing advanced autotuning.

Parameter		Function	When Enabled	Classification
<b>Pn460</b>	n.□□□0	Does not set the 1st notch filter automatically with the utility function.	Immediately	Tuning
	n.□□□1 [Factory setting]	Sets the 1st notch filter automatically with the utility function.		
	n.□0□□	Does not set the 2nd notch filter automatically with the utility function.		
	n.□1□□ [Factory setting]	Sets the 2nd notch filter automatically with the utility function.		

#### ■ Anti-Resonance Control Adjustment

This function reduces low vibration frequency, which the notch filter does not detect.

Usually, set this function to Auto Setting. (The anti-resonance control is factory-set to Auto Setting.)

When this function is set to Auto Setting, vibration will be automatically detected during advanced autotuning and anti-resonance control will be automatically adjusted and set.

Parameter		Function	When Enabled	Classification
<b>Pn160</b>	n.□□0□	Does not use the anti-resonance control automatically with the utility function.	Immediately	Tuning
	n.□□1□ [Factory setting]	Uses the anti-resonance control automatically with the utility function.		

#### ■ Vibration Suppression

The vibration suppression function suppresses transitional vibration at frequency as low as 1 to 100 Hz that is generated mainly when positioning if the machine stand vibrates.

Usually, set this function to Auto Setting. (The vibration suppression function is factory-set to Auto Setting.)

When this function is set to Auto Setting, vibration will be automatically detected during advanced autotuning and vibration suppression will be automatically adjusted and set.

Set this function to Not Auto Setting only if you do not change the setting for vibration suppression before executing advanced autotuning.

Note: This function uses model following control. Therefore, the function can be executed only if the mode is set to 2 or 3.

#### • Related Parameter

Parameter		Function	When Enabled	Classification
<b>Pn140</b>	n.□0□□	Does not use the vibration suppression function automatically with the utility function.	Immediately	Tuning
	n.□1□□ [Factory setting]	Uses the vibration suppression function automatically with the utility function.		

## ■ Friction Compensation

This function compensates for changes in the following conditions.

- Changes in the viscous resistance of the lubricant, such as the grease, on the sliding parts of the machine
- Changes in the friction resistance resulting from variations in the machine assembly
- Changes in the friction resistance due to aging

The conditions for applying friction compensation depend on the mode. The friction compensation setting in Pn408.3 applies when the Mode is 1. The friction compensation function is always enabled regardless of the friction compensation setting in Pn408.3 when the Mode is 2 or 3.

Friction Compensation Selecting		Mode		
		Mode = 1	Mode = 2	Mode = 3
Pn408	n.0□□□ [Factory setting]	Adjusted without the friction compensation function	Adjusted with the friction compensation function	Adjusted with the friction compensation function
	n.1□□□	Adjusted with the friction compensation function		

## ■ Feedforward

If Pn140 is set to the factory setting and the mode setting is changed to 2 or 3, the feedforward gain (Pn109), speed feedforward input, and force feedforward input will be disabled.

Set Pn140.3 to 1 if model following control is used together with the speed feedforward input and force feedforward input from the host controller via the command option module.

Parameter		Function	When Enabled	Classification
Pn140	n.0□□□ [Factory setting]	Model following control is not used together with the speed/force feedforward input.	Immediately	Tuning
	n.1□□□	Model following control is used together with the speed/force feedforward input.		

For the force feedforward input and speed feedforward input, refer to the manual of the connected command option module.

 <b>IMPORTANT</b>	<p>Model following control is used to make optimum feedforward settings in the SERVO-PACK when model following control is used with the feedforward function. Therefore, model following control is not normally used together with either the speed feedforward input or force feedforward input from the host controller. However, model following control can be used with the speed feedforward input or force feedforward input if required. An improper feedforward input may result in overshooting.</p>
---	---

### 5.3.3 Related Parameters

The following table lists parameters related to this function and their possibility of being changed while executing this function or of being changed automatically after executing this function.

- Parameters related to this function

These are parameters that are used or referenced when executing this function.

- Allowed changes during execution of this function

Yes : Parameters can be changed using SigmaWin+ while this function is being executed.

No : Parameters cannot be changed using SigmaWin+ while this function is being executed.

- Automatic changes after execution of this function

Yes : Parameter set values are automatically set or adjusted after execution of this function.

No : Parameter set values are not automatically set or adjusted after execution of this function.

Parameter	Name	Mid-execution changes	Automatic changes
<b>Pn100</b>	Speed Loop Gain	No	Yes
<b>Pn101</b>	Speed Loop Integral Time Constant	No	Yes
<b>Pn102</b>	Position Loop Gain	No	Yes
<b>Pn103</b>	Mass Ratio	No	No
<b>Pn121</b>	Friction Compensation Gain	No	Yes
<b>Pn123</b>	Friction Compensation Coefficient	No	Yes
<b>Pn124</b>	Friction Compensation Frequency Correction	No	No
<b>Pn125</b>	Friction Compensation Gain Correction	No	Yes
<b>Pn401</b>	Force Reference Filter Time Constant	No	Yes
<b>Pn408</b>	Force Related Function Switch	Yes	Yes
<b>Pn409</b>	1st Notch Filter Frequency	No	Yes
<b>Pn40A</b>	1st Notch Filter Q Value	No	Yes
<b>Pn40C</b>	2nd Notch Filter Frequency	No	Yes
<b>Pn40D</b>	2nd Notch Filter Q Value	No	Yes
<b>Pn140</b>	Model Following Control Related Switch	Yes	Yes
<b>Pn141</b>	Model Following Control Gain	No	Yes
<b>Pn142</b>	Model Following Control Gain Compensation	No	Yes
<b>Pn143</b>	Model Following Control Bias (Forward Direction)	No	Yes
<b>Pn144</b>	Model Following Control Bias (Reverse Direction)	No	Yes
<b>Pn145</b>	Vibration Suppression 1 Frequency A	No	Yes
<b>Pn146</b>	Vibration Suppression 1 Frequency B	No	Yes
<b>Pn147</b>	Model Following Control Speed Feedforward Compensation	No	Yes
<b>Pn160</b>	Anti-Resonance Control Related Switch	Yes	Yes
<b>Pn161</b>	Anti-Resonance Frequency	No	Yes
<b>Pn163</b>	Anti-Resonance Damping Gain	No	Yes
<b>Pn531</b>	Program JOG Movement Distance	No	No
<b>Pn585</b>	Program JOG Movement Speed	No	No
<b>Pn534</b>	Program JOG Acceleration/Deceleration Time	No	No
<b>Pn535</b>	Program JOG Waiting Time	No	No
<b>Pn536</b>	Number of Times of Program JOG Movement	No	No

## 5.4 Advanced Autotuning by Reference (Fn202)

Adjustments with advanced autotuning by reference are described below.



### IMPORTANT

- Advanced autotuning by reference starts adjustments based on the set speed loop gain (Pn100). Therefore, precise adjustments cannot be made if there is vibration when starting adjustments. In this case, make adjustments after lowering the speed loop gain (Pn100) until vibration is eliminated.

### 5.4.1 Advanced Autotuning by Reference

Advanced autotuning by reference is used to automatically achieve optimum tuning of the SERVOPACK in response to the user reference inputs from the host controller.

Advanced autotuning by reference is performed generally to fine-tune the SERVOPACK after advanced autotuning of the SERVOPACK has been performed.

If the mass ratio is correctly set to Pn103, advanced autotuning by reference can be performed without performing advanced autotuning.

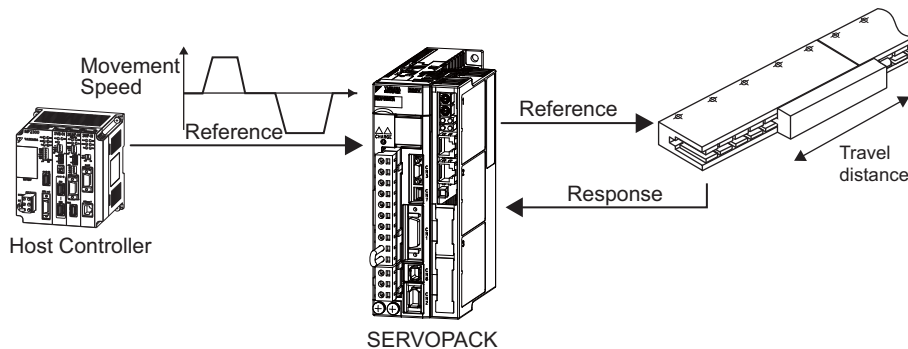

Advanced autotuning by reference performs the following adjustments.

- Gains (e.g., position loop gain and speed loop gain)
- Filters (force reference filter and notch filter)
- Friction compensation
- Anti-resonance control
- Vibration suppression

Refer to 5.4.3 *Related Parameters* for parameters used for adjustments.

For the input method of the operation reference, refer to the manual for the connected command option module.



### CAUTION

- Because advanced autotuning by reference adjusts the SERVOPACK during automatic operation, vibration or overshooting may occur. To ensure safety, perform advanced autotuning by reference in a state where the SERVOPACK can come to an emergency stop at any time.

## (1) Preparation

Check the following settings before performing advanced autotuning by reference. The message “NO-OP” indicating that the settings are not appropriate will be displayed, if all of the following conditions are not met.

- The SERVOPACK must be in Servo Ready status (Refer to 4.6.4).
- There must be no overtravel.
- The servomotor power must be OFF.
- The position control must be selected when the servomotor power is ON.
- The gain selection switch must be in manual switching mode (Pn139.0 = 0).
- Gain setting 1 must be selected.
- The test without a motor function must be disabled (Pn00C.0 = 0).
- All alarms and warnings must be cleared.
- The write prohibited setting (Fn010) must be set to Write permitted (P.0000).
- The tuning-less function must be disabled (Pn170.0 = 0).

## (2) When Advanced Autotuning by Reference Cannot Be Performed Successfully

Advanced autotuning by reference cannot be performed successfully under the following conditions. If the result of autotuning is not satisfactory, perform one-parameter tuning (Fn203). Refer to 5.5 *One-parameter Tuning (Fn203)* for details.

- The travel distance in response to references from the host controller is smaller than the set positioning completed width (Pn522).
- The motor speed in response to references from the host controller is smaller than the set zero speed level (Pn581).
- The stopping time, i.e., the period while the positioning completed /COIN signal is OFF, is 10 ms or less.
- The rigidity of the machine is low and vibration occurs when positioning is performed.
- The position integration function is used.
- P control operation (proportional control) is performed.
- The mode switch is used.
- The positioning completed width (Pn522) is too small.



### IMPORTANT

- Advanced autotuning by reference starts adjustments based on the positioning completed width (Pn522). Set the electronic gear ratio (Pn20E/Pn210) and positioning completed width (Pn522) to the actual value during operation.
- “WAITING” will flash if the positioning completed signal (/COIN) does not turn ON within approximately 3 seconds after positioning is completed. Furthermore, unless the positioning completed signal (/COIN) is turned ON within approximately 10 seconds, “Error” will flash for 2 seconds and tuning will be aborted.

Change only the overshoot detection level (Pn561) to finely adjust the amount of overshooting without changing the positioning completed width (Pn522). Because Pn561 is set by default to 100%, the allowable amount of overshooting is the same amount as that for the positioning completed width.

When Pn561 is set to 0%, the amount of overshooting can be adjusted without any overshooting in the positioning completed width. If the setting of Pn561 is changed, however, the positioning time may be extended.

Pn561	Overshoot Detection Level				Classification
	Setting Range	Setting Unit	Speed	Position	
			Force	When Enabled	
	0 to 100	1%	100	Immediately	Setup

### 5.4.2 Advanced Autotuning by Reference Procedure

The following procedure is used for advanced autotuning by reference.





















Advanced autotuning by reference is performed from the digital operator (option) or SigmaWin+.

Here, the operating procedure from the digital operator is described.



Refer to the *ΣV Series User's Manual, Operation of Digital Operator* (No.: SIEP S800000 55) for basic key operations of the digital operator.

#### (1) Operating Procedure

Set the correct mass ratio in Pn103 by using the advanced autotuning before performing this procedure.

Step	Display after Operation	Keys	Operation
1	<pre> BB      —FUNCTION— Fn201: AAT Fn202: Ref-AAT Fn203: OnePrmTun Fn204: A-Vib Sup                     </pre>	  	Press the  Key to view the main menu for the utility function. Use the  or  Key to move through the list and select Fn202.
2	<pre>       Status Display BB      Advanced AT Mode=3 Type=2                     </pre>		Press the  Key to display the initial setting screen for Fn202 (Advanced Autotuning by Reference).
3	<pre> BB      Advanced AT Mode=3 Type=2                     </pre>	  	Press the  ,  , or  Key and set the items in steps 3-1 and 3-2.
3-1	<p>■Mode Selection                      Select the mode.                      Mode = 1: Makes adjustments considering response characteristics and stability (Standard level).                      Mode = 2: Makes adjustments for positioning [Factory setting].                      Mode = 3: Makes adjustments for positioning, giving priority to overshooting suppression.</p>		
3-2	<p>■Type Selection                      Select the type according to the machine element to be driven.                      If there is noise or the gain does not increase, better results may be obtained by changing the rigidity type.                      Type = 1: Low rigidity                      Type = 2: Medium rigidity [Factory setting]                      Type = 3: High rigidity</p>		
4	<pre> BB      Advanced AT Pn103=00300 Pn100=0040.0 Pn101=0020.00 Pn141=0050.0                     </pre>		Press the  Key. The advanced autotuning by reference execution screen will be displayed. Note: If the mode is set to 1, Pn102 is displayed. If the mode is set to 2 or 3, the Pn102 display will change to the Pn141.
5	<pre> RUN      Advanced AT Pn103=00300 Pn100=0040.0 Pn101=0020.00 Pn141=0050.0                     </pre>	—	Input the servo ON command from the host controller.
6	<pre> ADJ      Advanced AT Pn103=00300 Pn100=0100.0 Pn101=0006.36 Pn141=0150.0                     </pre>	 	Input a reference from the host controller and then press the  or  Key to start the adjustment. "ADJ" will flash during adjustment on the status display. Note: Adjustment cannot be performed during "BB" is shown on the status display.

(cont'd)

Step	Display after Operation	Keys	Operation
7	<pre> A D J      A d v a n c e d   A T P n 1 0 3 = 0 0 3 0 0 P n 1 0 0 = 0 1 0 0 . 0 P n 1 0 1 = 0 0 0 6 . 3 6 P n 1 4 1 = 0 1 5 0 . 0 </pre>	—	When the adjustment has been completed normally, "END" will flash for approximately two seconds and "ADJ" will be displayed.
8	<pre> R U N      A d v a n c e d   A T P n 1 0 3 = 0 0 3 0 0 P n 1 0 0 = 0 1 0 0 . 0 P n 1 0 1 = 0 0 0 6 . 3 6 P n 1 4 1 = 0 1 5 0 . 0 </pre>	<div style="border: 1px solid black; padding: 2px; display: inline-block;">DATA</div>	Press the  Key to save the settings. "DONE" will flash for approximately two seconds and "RUN" will be displayed. Note: Not to save the values set in step 6, press the  Key. The display will return to that shown in step 1.

## (2) Failure in Operation

## ■ When "NO-OP" Flashes on the Display

Probable Cause	Corrective Actions
The main circuit power supply was OFF.	Turn ON the main circuit power supply.
An alarm or warning occurred.	Remove the cause of the alarm or the warning.
Overtraveling occurred.	Remove the cause of the overtravel.
Gain setting 2 was selected by gain switching.	Disable the automatic gain switching.
HWBB operated.	Disable the HWBB function.

## ■ When "Error" Flashes on the Display

Error	Probable Cause	Corrective Actions
The gain adjustment was not successfully completed.	Machine vibration is occurring or the positioning completed signal (/COIN) is turning ON and OFF when the servomotor is stopped.	<ul style="list-style-type: none"> <li>• Increase the set value for Pn522.</li> <li>• Change the mode from 2 to 3.</li> <li>• If machine vibration occurs, suppress the vibration with the anti-resonance control adjustment function and the vibration suppression function.</li> </ul>
The positioning completed signal (/COIN) did not turn ON within approximately 10 seconds after positioning adjustment was completed.	The positioning completed width is too narrow or proportional control (P control) is being used.	<ul style="list-style-type: none"> <li>• Increase the set value for Pn522.</li> <li>• Clear the P control action setting.</li> </ul>

### (3) Related Functions on Advanced Autotuning by Reference

This section describes functions related to advanced autotuning by reference.

#### ■ Notch Filter

Usually, set this function to Auto Setting. (The notch filter is factory-set to Auto Setting.)

If this function is set to Auto Setting, vibration will be detected automatically during advanced autotuning by reference, and the notch filter will be set.

Set this function to Not Auto Setting only if you do not change the notch filter setting before executing advanced autotuning by reference.

Parameter		Function	When Enabled	Classification
Pn460	n.□□□0	Does not set the 1st notch filter automatically with the utility function.	Immediately	Tuning
	n.□□□1 [Factory setting]	Sets the 1st notch filter automatically with the utility function.		
	n.□0□□	Does not set the 2nd notch filter automatically with the utility function.		
	n.□1□□ [Factory setting]	Sets the 2nd notch filter automatically with the utility function.		

#### ■ Anti-Resonance Control Adjustment

This function reduces low vibration frequency, which the notch filter does not detect.

Usually, set this function to Auto Setting. (The anti-resonance control is factory-set to Auto Setting.)

When this function is set to Auto Setting, vibration will be automatically detected during advanced autotuning by reference and anti-resonance control will be automatically adjusted and set.

Parameter		Function	When Enabled	Classification
Pn160	n.□□0□	Does not use the anti-resonance control automatically with the utility function.	Immediately	Tuning
	n.□□1□ [Factory setting]	Uses the anti-resonance control automatically with the utility function.		

#### ■ Vibration Suppression

The vibration suppression function suppresses transitional vibration at frequency as low as 1 to 100 Hz that is generated mainly when positioning if the machine stand vibrates.

Usually, set this function to Auto Setting. (The vibration suppression function is factory-set to Auto Setting.)

When this function is set to Auto Setting, vibration will be automatically detected during advanced autotuning by reference and vibration suppression will be automatically adjusted and set.

Set this function to Not Auto Setting only if you do not change the setting for vibration suppression before executing advanced autotuning by reference.

Note: This function uses model following control. Therefore, the function can be executed only if the mode is set to 2 or 3.

#### • Related Parameters

Parameter		Function	When Enabled	Classification
Pn140	n.□0□□	Does not use the vibration suppression function automatically.	Immediately	Tuning
	n.□1□□ [Factory setting]	Uses the vibration suppression function automatically.		

### ■ Friction Compensation

This function compensates for changes in the following conditions.

- Changes in the viscous resistance of the lubricant, such as the grease, on the sliding parts of the machine
- Changes in the friction resistance resulting from variations in the machine assembly
- Changes in the friction resistance due to aging

Conditions to which friction compensation is applicable depend on the mode. The friction compensation setting in Pn408.3 applies when the mode is 1. Mode = 2 and Mode = 3 are adjusted with the friction compensation function regardless of the friction compensation setting in P408.3.

Friction Compensation Selecting		Mode = 1	Mode = 2	Mode = 3
Pn408	n.0□□□ [Factory setting]	Adjusted without the friction compensation function	Adjusted with the friction compensation function	Adjusted with the friction compensation function
	n.1□□□	Adjusted with the friction compensation function		

### ■ Feedforward

If Pn140 is set to the factory setting and the mode setting is changed to 2 or 3, the feedforward gain (Pn109), speed feedforward input, and force feedforward input will be disabled.

Set Pn140.3 to 1 if model following control is used together with the speed feedforward input and force feedforward input from the host controller via the command option module.

Parameter	Function	When Enabled	Classification
Pn140	n.0□□□ [Factory setting]	Immediately	Tuning
	n.1□□□		

For the force feedforward input and speed feedforward input, refer to the manual for the connected command option module.



#### IMPORTANT

Model following control is used to make optimum feedforward settings in the SERVO-PACK when model following control is used with the feedforward function. Therefore, model following control is not normally used together with either the speed feedforward input or force feedforward input from the host controller. However, model following control can be used with the speed feedforward input or force feedforward input if required. An improper feedforward input may result in overshooting.

### 5.4.3 Related Parameters

The following table lists parameters related to this function and their possibility of being changed while executing this function or of being changed automatically after executing this function.

- Parameters related to this function

These are parameters that are used or referenced when executing this function.

- Allowed changes during execution of this function

Yes: Parameters can be changed using SigmaWin+ while this function is being executed.

No: Parameters cannot be changed using SigmaWin+ while this function is being executed.

- Automatic changes after execution of this function

Yes: Parameter set values are automatically set or adjusted after execution of this function.

No: Parameter set values are not automatically set or adjusted after execution of this function.

Parameter	Name	Mid-execution changes	Automatic changes
<b>Pn100</b>	Speed Loop Gain	No	Yes
<b>Pn101</b>	Speed Loop Integral Time Constant	No	Yes
<b>Pn102</b>	Position Loop Gain	No	Yes
<b>Pn103</b>	Mass Ratio	No	No
<b>Pn121</b>	Friction Compensation Gain	No	Yes
<b>Pn123</b>	Friction Compensation Coefficient	No	Yes
<b>Pn124</b>	Friction Compensation Frequency Correction	No	No
<b>Pn125</b>	Friction Compensation Gain Correction	No	Yes
<b>Pn401</b>	Force Reference Filter Time Constant	No	Yes
<b>Pn408</b>	Force Related Function Switch	Yes	Yes
<b>Pn409</b>	1st Notch Filter Frequency	No	Yes
<b>Pn40A</b>	1st Notch Filter Q Value	No	Yes
<b>Pn40C</b>	2nd Notch Filter Frequency	No	Yes
<b>Pn40D</b>	2nd Notch Filter Q Value	No	Yes
<b>Pn140</b>	Model Following Control Related Switch	Yes	Yes
<b>Pn141</b>	Model Following Control Gain	No	Yes
<b>Pn142</b>	Model Following Control Gain Compensation	No	Yes
<b>Pn143</b>	Model Following Control Bias (Forward Direction)	No	Yes
<b>Pn144</b>	Model Following Control Bias (Reverse Direction)	No	Yes
<b>Pn145</b>	Vibration Suppression 1 Frequency A	No	Yes
<b>Pn146</b>	Vibration Suppression 1 Frequency B	No	Yes
<b>Pn147</b>	Model Following Control Speed Feedforward Compensation	No	Yes
<b>Pn160</b>	Anti-Resonance Control Related Switch	Yes	Yes
<b>Pn161</b>	Anti-Resonance Frequency	No	Yes
<b>Pn163</b>	Anti-Resonance Damping Gain	No	Yes

## 5.5 One-parameter Tuning (Fn203)

Adjustments with one-parameter tuning are described below.

### 5.5.1 One-parameter Tuning

One-parameter tuning is used to manually make tuning level adjustments during operation with a position reference or speed reference input from the host controller.

One-parameter tuning enables automatically setting related servo gain settings to balanced conditions by adjusting one or two tuning levels.

One-parameter tuning performs the following adjustments.

- Gains (e.g., position loop gain and speed loop gain)
- Filters (force reference filter and notch filter)
- Friction compensation
- Anti-resonance control

Refer to 5.5.4 *Related Parameters* for parameters used for adjustments.

For the input method of the position reference or speed reference, refer to the manual for the connected command option module.

<NOTE>

Perform one-parameter tuning if satisfactory response characteristics is not obtained with advanced autotuning or advanced autotuning by reference.

To fine-tune each servo gain after one-parameter tuning, refer to 5.8 *Additional Adjustment Function*.



### CAUTION

- Vibration or overshooting may occur during adjustment. To ensure safety, perform one-parameter tuning in a state where the SERVOPACK can come to an emergency stop at any time.

#### (1) Preparation

Check the following settings before performing one-parameter tuning.

The message “NO-OP” indicating that the settings are not appropriate will be displayed, if all of the following conditions are not met.

- The test without a motor function must be disabled (Pn00C.0 = 0).
- The write prohibited setting (Fn010) must be set to Write permitted (P.0000).
- The tuning-less function must be disabled (Pn170.0 = 0).
- The tuning mode must be set to 0 or 1 when performing speed control.

### 5.5.2 One-parameter Tuning Procedure

The following procedure is used for one-parameter tuning.

There are the following two operation procedures depending on the tuning mode being used.

- When the tuning mode is set to 0 or 1, the model following control will be disabled and one-parameter tuning will be used as the tuning method for applications other than positioning.
- When the tuning mode is set to 2 or 3, the model following control will be enabled and it can be used for tuning for positioning.

One-parameter tuning is performed from the digital operator (option) or SigmaWin+.





















Make sure that the mass ratio (Pn103) is set correctly using advance autotuning before beginning operation.

The following section provides the operating procedure from the digital operator.























Refer to the *ΣV Series User's Manual, Operation of Digital Operator* (No.: SIEP S800000 55) for basic key operations of the digital operator.

#### (1) Digital Operator Operating Procedure

##### ■ Setting the Tuning Mode 0 or 1

























Step	Display after Operation	Keys	Operation
1	<pre> BB      —FUNCTION— Fn202: Ref-AAT Fn203: OnePrmTun Fn204: A-Vib Sup Fn205: Vib Sup                     </pre>	  	Press the  Key to view the main menu for the utility function. Press the  or  Key to move through the list and select Fn203.
2	<pre> ┌── Status Display │ │ BB      —OnePrmTun— │ Pn103=00300 │ └──                     </pre>		Press the  Key to display the mass ratio set in Pn103 at present. Move the digit with the  or  Key and change the value with the  or  Key.
3	<pre> BB      —OnePrmTun— Setting Tuning Mode = 0 Type = 2                     </pre>		Press the  Key to display the initial setting screen for Fn203 (One-parameter Tuning).
4	<pre> BB      —OnePrmTun— Setting Tuning Mode = 0 Type = 2                     </pre>	  	Press the  ,  , or  Key and set the items in steps 4-1 and 4-2.
4-1	<b>■Tuning Mode</b> Select the tuning mode. Select the tuning mode 0 or 1. Tuning Mode = 0: Makes adjustments giving priority to stability. Tuning Mode = 1: Makes adjustments giving priority to responsiveness.		
4-2	<b>■Type Selection</b> Select the type according to the machine element to be driven. If there is noise or the gain does not increase, better results may be obtained by changing the rigidity type. Type = 1: Low rigidity Type = 2: Medium rigidity [Factory setting] Type = 3: High rigidity		
5	<pre> RUN      —OnePrmTun— Setting Tuning Mode = 0 Type = 2                     </pre>	—	If the servomotor power is not ON, input the servo ON command from the host controller. The display will change from "BB" to "RUN." If the servomotor power is ON, go to step 6.

(cont'd)

Step	Display after Operation	Keys	Operation
6	<pre> RUN  -OnePrmTun- Pn100=0040.0 Pn101=0020.00 Pn102=0040.0 </pre>		Press the  Key to display the set value.
7	<pre> RUN  -OnePrmTun-       LEVEL = 00<u>5</u>0 NF1  NF2   ARES </pre>		Press the  Key again to display the LEVEL setting screen.
8	<pre> RUN  -OnePrmTun-       LEVEL = 00<u>5</u>0 NF1  NF2   ARES </pre>	   	<p>If readjustment is required, select the digit with the  or  Key or change the LEVEL with the  or  Key. Check the response.</p> <p>If readjustment is not required, go to step 9.</p> <p>Note: The higher the level, the greater the responsiveness will be. If the value is too large, however, vibration will occur.</p> <ul style="list-style-type: none"> <li>If vibration occurs, press the  Key. The SERVOPACK will automatically detect the vibration frequencies and make notch filter or an anti-resonance control settings. When the notch filter is set, "NF1" or "NF2" will be displayed on the bottom row. When the anti-resonance control is set, "ARES" will be displayed in the lower right corner.</li> </ul> <pre> RUN  -OnePrmTun-       LEVEL=00<u>7</u>0 NF1  NF2   ARES </pre> <ul style="list-style-type: none"> <li>If the vibration is great, the vibration frequency will be detected automatically even if the  Key is not pressed and a notch filter or an anti-resonance control will be set.</li> </ul>
9	<pre> RUN  -OnePrmTun- Pn100=0050.0 Pn101=0016.0 Pn102=0050.0 </pre>		Press the  Key. A confirmation screen will be displayed after LEVEL adjustment.
10	<pre> RUN  -OnePrmTun- Pn100=00<u>5</u>0.0 Pn101=00<u>1</u>6.0 Pn102=00<u>5</u>0.0 </pre>		<ul style="list-style-type: none"> <li>Press the  Key to save the adjusted values. After the data is saved, "DONE" will flash for approximately two seconds and then "RUN" will be displayed.</li> <li>To return to the previous value, press the  Key.</li> <li>Press the  Key to readjust the level without saving the values.</li> </ul>
11	<pre> RUN  -FUNCTION- Fn202: Ref-AAT Fn203: OnePrmTun Fn204: A-Vib Sup Fn205: Vib Sup </pre>		Press the  Key to complete the one-parameter tuning operation. The screen in step 1 will appear again.











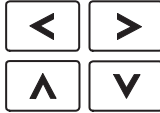



Note: The status display will always be RUN when the servomotor power is ON.

## ■ Setting the Tuning Mode 2 or 3

Step	Display after Operation	Keys	Operation
1	<pre>BB  —FUNCTION— Fn202:Ref-AAT Fn203:OnePrmTun Fn204:A-Vib Sup Fn205:Vib Sup</pre>	  	<p>Press the  Key to view the main menu for the utility function.</p> <p>Press the  or  Key to move through the list and select Fn203.</p>
2	<pre>— Status Display BB  —OnePrmTun— Pn103=00300</pre>		<p>Press the  Key to display the mass ratio set in Pn103 at present. Move the digit with the  or  Key and change the value with the  or  Key.</p>
3	<pre>BB  —OnePrmTun— Setting Tuning Mode = 2 Type = 2</pre>		<p>Press the  Key to display the initial setting screen for Fn203 (One-parameter Tuning).</p>
4	<pre>BB  —OnePrmTun— Setting Tuning Mode = 2 Type = 2</pre>	  	<p>Press the , , or  Key and set the items in steps 4-1 and 4-2.</p>
4-1	<p>■Tuning Mode  Select the tuning mode. Select the tuning mode 2 or 3.  Tuning Mode = 2: Enables model following control and makes adjustments for positioning.  Tuning Mode = 3: Enables model following control, makes adjustments for positioning, and suppresses overshooting.</p>		
4-2	<p>■Type Selection  Select the type according to the machine element to be driven.  If there is noise or the gain does not increase, better results may be obtained by changing the rigidity type.  Type = 1: Low rigidity  Type = 2: Medium rigidity [Factory setting]  Type = 3: High rigidity</p>		
5	<pre>RUN  —OnePrmTun— Setting Tuning Mode=2 Type=2</pre>	—	<p>If the servomotor power is not ON, input the servo ON command from the host controller. The display will change from "BB" to "RUN."  If the servomotor power is ON, go to step 6.</p>
6	<pre>RUN  —OnePrmTun— Pn100=0040.0 Pn101=0020.00 Pn141=0050.0</pre>		<p>Press the  Key to display the set value.</p>
7	<pre>RUN  —OnePrmTun— FF LEVEL=0050.0 FB LEVEL=0040.0</pre>		<p>Press the  Key again to display FF LEVEL and FB LEVEL setting screens.</p>

Note: The status display will always be RUN when the servomotor power is ON.

(cont'd)

Step	Display after Operation	Keys	Operation
8	<pre> RUN  —OnePrmTun— FF LEVEL=0050.0 FB LEVEL=0040.0           </pre>		<p>If readjustment is required, select the digit with the  or  Key or change the FF LEVEL and FB LEVEL with the  or  Key. Check the response.</p> <p>Refer to 5.5.3 <i>One-parameter Tuning Example</i> for details.</p> <p>If readjustment is not required, go to step 9.</p> <p>Note: The higher the FF LEVEL, the positioning time will be shorter and the response will be better. If the level is too high, however, overshooting or vibration may occur. Overshooting will be reduced if the FB LEVEL is increased.</p> <p>&lt;NOTE&gt;</p> <ul style="list-style-type: none"> <li>If the FF LEVEL is changed when the servomotor is in operation, it will not be reflected immediately. The changes will be effective after the servomotor comes to a stop with no reference input and then the servomotor starts operation.</li> <li>If the FF LEVEL is changed too much during operation, vibration may occur because the responsiveness changes rapidly when the settings become effective.</li> <li>The message “FF LEVEL” flashes until the SERVOPACK reaches the effective FF LEVEL. If the servomotor does not stop within approximately 10 seconds after changing the setting, a timeout will occur. The setting will be returned to the previous value.</li> </ul> <p>■ If Vibration Occurs</p> <ul style="list-style-type: none"> <li>If vibration occurs, press the  Key. The SERVOPACK will automatically detect the vibration frequencies and set the notch filters or anti-resonance control. When the notch filter is set, “NF1” and “NF2” are displayed on the bottom row. When the anti-resonance control is set, “ARES” will be displayed on the bottom row.</li> </ul> <pre> RUN  —OnePrmTun— FF LEVEL=0050.0 FB LEVEL=0040.0 NF1  NF2  ARES           </pre> <p>■ If Vibration Is Large</p> <ul style="list-style-type: none"> <li>Even if the  Key is not pressed, the SERVOPACK will automatically detect the vibration frequencies and make notch filter or anti-resonance control settings.</li> </ul>
9	<pre> RUN  —OnePrmTun— Pn100=0040.0 Pn101=0020.00 Pn141=0050.0 NF1           </pre>		<p>Press the  Key to display the confirmation screen after level adjustment.</p>
10	<pre> RUN  —OnePrmTun— Pn100=0040.0 Pn101=0020.00 Pn141=0050.0 NF1           </pre>		<ul style="list-style-type: none"> <li>Press the  Key to save the adjusted values. After the data is saved, “DONE” will flash for approximately two seconds and then “RUN” will be displayed.</li> <li>To return to the previous value, press the  Key.</li> <li>Press the  Key to readjust the level without saving the values.</li> </ul>
11	<pre> RUN  —FUNCTION— Fn202:Ref-AAT Fn203:OnePrmTun Fn204:A-Vib Sup Fn205:Vib Sup           </pre>		<p>Press the  Key to complete the one-parameter tuning operation. The screen in step 1 will appear again.</p>

## (2) Related Functions on One-parameter Tuning

This section describes functions related to one-parameter tuning.

### ■ Notch Filter

Usually, set this function to Auto Setting. (The notch filter is factory-set to Auto Setting.)

If this function is set to Auto Setting, vibration will be detected automatically during one-parameter tuning and the notch filter will be set.

Set this function to Not Auto Setting only if you do not change the notch filter setting before executing one-parameter tuning.

Parameter		Function	When Enabled	Classification
<b>Pn460</b>	n.□□□0	Does not set the 1st notch filter automatically with the utility function.	Immediately	Tuning
	n.□□□1 [Factory setting]	Sets the 1st notch filter automatically with the utility function.		
	n.□0□□	Does not set the 2nd notch filter automatically with the utility function.		
	n.□1□□ [Factory setting]	Sets the 2nd notch filter automatically with the utility function.		

### ■ Anti-Resonance Control Adjustment

This function reduces low vibration frequency, which the notch filter does not detect.

Usually, set this function to Auto Setting. (The anti-resonance control is factory-set to Auto Setting.)

When this function is set to Auto Setting, vibration will be automatically detected during one-parameter tuning and anti-resonance control will be automatically adjusted and set.

Parameter		Function	When Enabled	Classification
<b>Pn160</b>	n.□□0□	Does not use the anti-resonance control automatically with the utility function.	Immediately	Tuning
	n.□□1□ [Factory setting]	Uses the anti-resonance control automatically with the utility function.		

"ARES" will flash on the digital operator when anti-resonance control adjustment function is set.

```

RUN      —OnePrmTun—
FF LEVEL = 0050
FB LEVEL = 0040

NF1 NF2  ARES

```

### ■ Friction Compensation

This function compensates for changes in the following conditions.

- Changes in the viscous resistance of the lubricant, such as the grease, on the sliding parts of the machine
- Changes in the friction resistance resulting from variations in the machine assembly
- Changes in the friction resistance due to aging

Conditions to which friction compensation is applicable depend on the tuning mode. The friction compensation setting in F408.3 applies when the mode is 0 or 1. Tuning Mode = 2 and Tuning Mode = 3 are adjusted with the friction compensation function regardless of the friction compensation setting in P408.3.

Friction Compensation Selecting		Mode			
		Tuning Mode = 0	Tuning Mode = 1	Tuning Mode = 2	Tuning Mode = 3
<b>Pn408</b>	n.0□□□ [Factory setting]	Adjusted without the friction compensation function	Adjusted without the friction compensation function	Adjusted with the friction compensation function	Adjusted with the friction compensation function
	n.1□□□	Adjusted with the friction compensation function	Adjusted with the friction compensation function		

### ■ Feedforward

If Pn140 is set to the factory setting and the tuning mode setting is changed to 2 or 3, the feedforward gain (Pn109), speed feedforward input, and force feedforward input will be disabled.

Set Pn140.3 to 1 if model following control is used together with the speed feedforward input and force feedforward input from the host controller via the command option module.

Parameter		Function	When Enabled	Classification
<b>Pn140</b>	n.0□□□ [Factory setting]	Model following control is not used together with the speed/force feedforward input.	Immediately	Tuning
	n.1□□□	Model following control is used together with the speed/force feedforward input.		

For the force feedforward input and speed feedforward input, refer to the manual for the connected command option module.

 <b>IMPORTANT</b>	<p>Model following control is used to make optimum feedforward settings in the SERVO-PACK when model following control is used with the feedforward function. Therefore, model following control is not normally used together with either the speed feedforward input or force feedforward input from the host controller. However, model following control can be used with the speed feedforward input or force feedforward input if required. An improper feedforward input may result in overshooting.</p>
---	---

### 5.5.3 One-parameter Tuning Example

This section describes the procedure to adjust the FF LEVEL and FB LEVEL after step 8 of 5.5.2 (1) ■ *Setting the Tuning Mode 2 or 3* and the procedure to save the values after adjustment to the SERVOPACK.







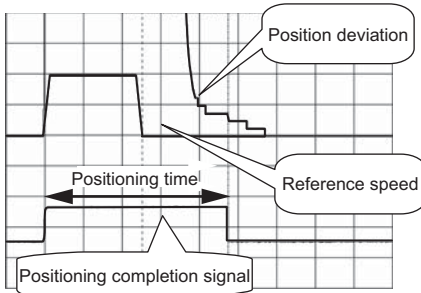

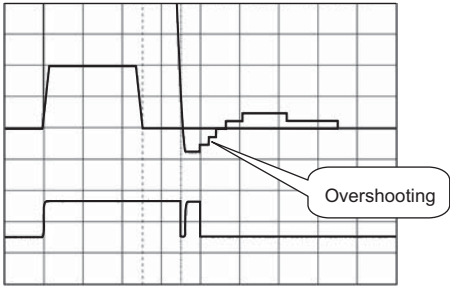

<NOTE>

Positioning time will be shortened if the FF LEVEL is increased. But overshooting and vibrations will occur if it is increased too much.

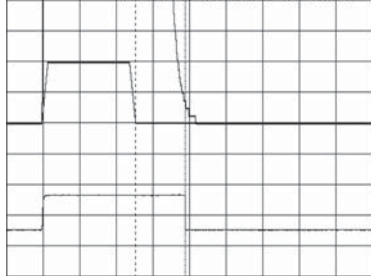
Overshooting will be reduced if the FB LEVEL is increased.

Step	Panel Display after Operation or Measurement Results Display Example	Operation
1	-	Perform steps 1 through 7 of 5.5.2 (1) ■ <i>Setting the Tuning Mode 2 or 3</i> .
2		<p>Measure the positioning time.</p> <p>If the measurement results and specifications are met, this concludes the tuning. Go to step 8.</p> <p>If readjustment is required, go to the next step.</p>
3	<pre> RUN  —OnePrmTun— FF LEVEL=0050.0 FB LEVEL=0040.0 </pre>	<p>First input the reference from the host controller, and then increase the FF LEVEL with the digital operator to shorten the positioning time.</p> <p>Note 1. If the FF LEVEL is changed when the servomotor is in operation, this value is not effective immediately. The changes will be effective after the servomotor comes to a stop with no reference input and then the servomotor starts operation.</p> <p>2. If the FF LEVEL is changed too much during operation, vibration may occur because the responsiveness changes rapidly when the settings become effective.</p> <p>3. If large vibrations occur, the SERVOPACK will automatically detect the vibration frequencies and set the notch filters or anti-resonance control. When a notch filter is set, “NF1” and “NF2” are displayed on the bottom row of the digital operator. When anti-resonance control is set, “ARES” is displayed on the bottom row of the digital operator.</p> <p>&lt;NOTE&gt;</p> <ul style="list-style-type: none"> <li>• Move the digit with the ◀ or ▶ Key and increase or decrease the value with the ▲ or ▼ Key.</li> <li>• The message “FF LEVEL” flashes until the SERVOPACK reaches the effective FF LEVEL. If the servomotor does not stop within approximately 10 seconds after changing the setting, a timeout will occur. The setting will be returned to the previous value.</li> </ul>

(cont'd)

Step	Panel Display after Operation or Measurement Results Display Example	Operation
4	 <p>In this measurement results example, the positioning time has decreased over the previous time, but overshooting has occurred.</p>	<p>Measure the positioning time with a measuring instrument.</p> <p>If the measurement results and specifications are met, this concludes the tuning. Go to step 8.</p> <p>Go to the next step if overshooting occurs before the specifications are met.</p>
5	<pre> RUN  -OnePrmTun- FF LEVEL=0050.0 FB LEVEL=0050.0           </pre>	<p>First input the reference from the host controller, then increase the FB LEVEL with the digital operator to reduce overshooting.</p> <p>&lt;NOTE&gt;</p> <p>Move the digit with the  or  Key and increase or decrease the value with the  or  Key.</p>
6		<p>Measure the positioning time with a measuring instrument.</p> <p>If the measurement results and specifications are met, this concludes the tuning. Go to step 8.</p> <p>Go back to step 3 if overshooting occurs before the specifications are met.</p> <p>Go to the next step if vibrations occur before overshooting stops.</p>
7	<pre> RUN  -OnePrmTun- FF LEVEL=0050.0 FB LEVEL=0050.0  NF1  NF2  ARES           </pre>	<p>Press the  Key on the digital operator.</p> <p>The SERVOPACK will automatically detect the vibration frequencies and set the notch filters or an anti-resonance control. When a notch filter is set, "NF1" or "NF2" is displayed on the bottom row of the digital operator. When anti-resonance control is set, "ARES" is displayed on the bottom row of the digital operator.</p> <p>&lt;NOTE&gt;</p> <p>If the vibration is large, a notch filter or anti-resonance control will be automatically set even if the  Key is not pressed.</p> <p>After making the setting, go back to step 6.</p>
8	<pre> RUN  -OnePrmTun- Pn100=0050.0 Pn101=0020.00 Pn141=0050.0 NF1           </pre>	<p>Press the  Key. A confirmation screen will be displayed after tuning.</p>
9	<pre> RUN  -OnePrmTun- Pn100=0050.0 Pn101=0020.00 Pn141=0050.0 NF1           </pre>	<p>Press the  Key. The tuning results data will be saved in the SERVOPACK.</p> <p>When the data has been saved, "DONE" will flash for two seconds, and then "RUN" will be displayed.</p> <p>&lt;NOTE&gt;</p> <ul style="list-style-type: none"> <li>• Press the  Key to cancel saving the data.</li> <li>• Press the  Key to readjust the FF LEVEL and FB LEVEL without saving the data.</li> </ul>

### 5.5.4 Related Parameters

The following table lists parameters related to this function and their possibility of being changed while executing this function or of being changed automatically after executing this function.

- Parameters related to this function

These are parameters that are used or referenced when executing this function.

- Allowed changes during execution of this function

Yes: Parameters can be changed using SigmaWin+ while this function is being executed.

No: Parameters cannot be changed using SigmaWin+ while this function is being executed.

- Automatic changes after execution of this function

Yes: Parameter set values are automatically set or adjusted after execution of this function.

No: Parameter set values are not automatically set or adjusted after execution of this function.

Parameter	Name	Mid-execution changes	Automatic changes
<b>Pn100</b>	Speed Loop Gain	No	Yes
<b>Pn101</b>	Speed Loop Integral Time Constant	No	Yes
<b>Pn102</b>	Position Loop Gain	No	Yes
<b>Pn103</b>	Mass Ratio	No	No
<b>Pn121</b>	Friction Compensation Gain	No	Yes
<b>Pn123</b>	Friction Compensation Coefficient	No	Yes
<b>Pn124</b>	Friction Compensation Frequency Correction	No	No
<b>Pn125</b>	Friction Compensation Gain Correction	No	Yes
<b>Pn401</b>	Force Reference Filter Time Constant	No	Yes
<b>Pn408</b>	Force Related Function Switch	Yes	Yes
<b>Pn409</b>	1st Notch Filter Frequency	No	Yes
<b>Pn40A</b>	1st Notch Filter Q Value	No	Yes
<b>Pn40C</b>	2nd Notch Filter Frequency	No	Yes
<b>Pn40D</b>	2nd Notch Filter Q Value	No	Yes
<b>Pn140</b>	Model Following Control Related Switch	Yes	Yes
<b>Pn141</b>	Model Following Control Gain	No	Yes
<b>Pn142</b>	Model Following Control Gain Compensation	No	Yes
<b>Pn143</b>	Model Following Control Bias (Forward Direction)	No	Yes
<b>Pn144</b>	Model Following Control Bias (Reverse Direction)	No	Yes
<b>Pn145</b>	Vibration Suppression 1 Frequency A	No	No
<b>Pn146</b>	Vibration Suppression 1 Frequency B	No	No
<b>Pn147</b>	Model Following Control Speed Feedforward Compensation	No	Yes
<b>Pn160</b>	Anti-Resonance Control Related Switch	Yes	Yes
<b>Pn161</b>	Anti-Resonance Frequency	No	Yes
<b>Pn163</b>	Anti-Resonance Damping Gain	No	Yes

## 5.6 Anti-Resonance Control Adjustment Function (Fn204)

This section describes the anti-resonance control adjustment function.

### 5.6.1 Anti-Resonance Control Adjustment Function

The anti-resonance control adjustment function increases the effectiveness of the vibration suppression after one-parameter tuning. This function is effective in supporting anti-resonance control adjustment if the vibration frequencies are from 100 to 1000 Hz.

This function rarely needs to be used because it is automatically set by the advanced autotuning or advanced autotuning by reference input. Use this function only if fine-tuning is required, or vibration detection is failed and readjustment is required.

Perform one-parameter tuning (Fn203) or use another method to improve the response characteristics after performing this function. If the anti-resonance gain is increased with one-parameter tuning performed, vibration may result again. If that occurs, perform this function again to fine-tune the settings.

#### CAUTION

- If this function is executed, related parameters will be set automatically. Therefore, there will be a large response change after this function is executed. Enable the function in a state where the machine can come to an emergency stop at any time to ensure the safety operation of the machine.
- Be sure to set a suitable value for the mass ratio (Pn103) using advanced autotuning before executing the anti-resonance control adjustment function. If the setting greatly differs from the actual mass ratio, normal control of the machine may not be possible, and vibration may result.



#### IMPORTANT

- This function detects vibration between 100 and 1000 Hz. Vibration will not be detected for frequencies outside of this range, and instead, "F----" will be displayed. If that occurs, use one-parameter tuning with tuning mode 2 selected to automatically set a notch filter or use the vibration suppression function (Fn205).
- Vibration can be reduced more effectively by increasing the anti-resonance damping gain (Pn163). The amplitude of vibration may become larger if the damping gain is excessively high. Increase the damping gain from about 0 to 200% in 10% increments while checking the effect of vibration reduction. If the effect of vibration reduction is still insufficient at a gain of 200%, cancel the setting, and lower the control gain using a different method, such as one-parameter tuning.

#### (1) Before Performing Anti-Resonance Control Adjustment Function

Check the following settings before performing anti-resonance control adjustment function.

The message "NO-OP" indicating that the settings are not appropriate will be displayed, if all of the following conditions are not met.

- The tuning-less function must be disabled (Pn170.0 = 0).
- The test without a motor function must be disabled (Pn00C.0 = 0).
- The control must not be set to force control.
- The write prohibited setting (Fn010) must be set to Write permitted (P.0000).

### 5.6.2 Anti-Resonance Control Adjustment Function Operating Procedure

With this function, an operation reference is sent, and the function is executed while vibration is occurring.

Anti-resonance control adjustment function is performed from the digital operator (option) or SigmaWin+. The following methods can be used for the anti-resonance control adjustment function.















- Using anti-resonance control for the first time
  - With undetermined vibration frequency
  - With determined vibration frequency
- For fine-tuning after adjusting the anti-resonance control

The following describes the operating procedure from the digital operator.







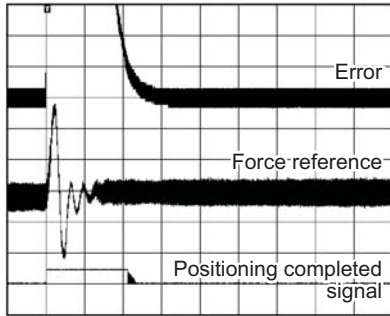













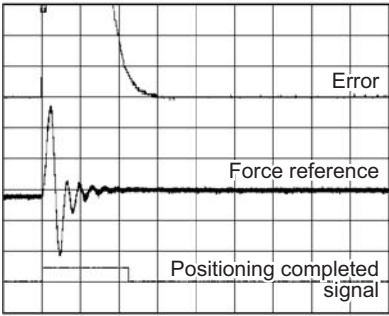



Refer to the *ΣV Series User's Manual, Operation of Digital Operator* (No.: SIEP S800000 55) for basic key operations of the digital operator.

#### (1) Using Anti-Resonance Control for the First Time























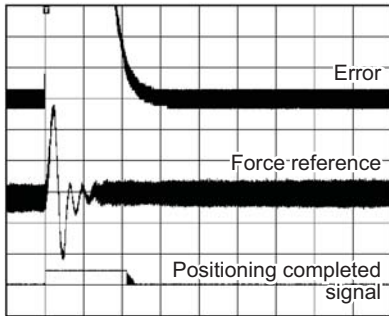

##### ■ With Undetermined Vibration Frequency

Step	Display after Operation	Keys	Operation
1	<pre> RUN      -FUNCTION- Fn203: OnePrmTun Fn204: A-Vib Sup Fn205: Vib Sup Fn206: Easy FFT                     </pre>	  	Press the  Key to view the main menu for the utility function. Use the  or  Key to move through the list, select Fn204.
2	<p>Status Display</p> <pre> RUN      - Vib Sup - Tuning Mode = 0                     </pre>		Press the  Key to display the tuning mode selection screen for Fn204 (anti-resonance control adjustment function).
3	<pre> RUN      - Vib Sup - Tuning Mode = 0                     </pre>	 	Press the  or  Key and set the tuning mode "0."
4	<pre> RUN      - Vib Sup - freq = ---- Hz damp = 0000                     </pre>		Press the  Key while "Tuning Mode = 0" is displayed. The screen shown on the left will appear. The detection of vibration frequencies will start and "freq" will flash. Return to step 3 if vibration is not detected. Note: If vibration is not detected even when vibration is occurring, lower the vibration detection sensitivity (Pn311). When this parameter is lowered, the detection sensitivity will be increased. Vibration may not be detected accurately if too small value is set.
5	<pre> RUN      - Vib Sup - freq = 0400 Hz damp = 0000                     </pre>	-	The vibration frequency will be displayed in "freq" if vibration is detected.  <p>Example of measured waveform</p>











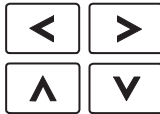

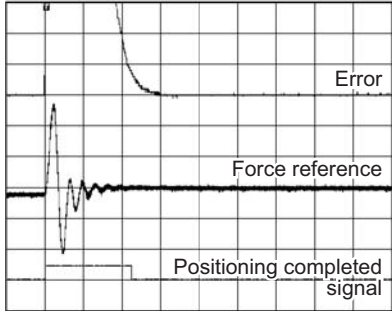

(cont'd)

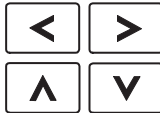
Step	Display after Operation	Keys	Operation
6	<pre> RUN      - Vib Sup - freq = 0400 Hz damp = 0000_                     </pre>		Press the  Key. The cursor will move to "damp," and the flashing of "freq" will stop.
7	<pre> RUN      - Vib Sup - freq = 0400 Hz damp = 0120_                     </pre>	   	Select the digit with the  or  Key, and press the  or  Key to set the damping gain.   <p>Example of measured waveform</p> <p>Note: Increase the damping gain from about 0 to 200% in 10% increments while checking the effect of vibration reduction. If vibration reduction is still insufficient at a gain of 200%, cancel the setting, and lower the control gain by using a different method, such as one-parameter tuning.</p>
8	<pre> RUN      - Vib Sup - freq = 0400 Hz damp = 0120_                     </pre>		If fine tuning of the frequency is necessary, press the  Key. The cursor will move from "damp" to "freq." If fine-tuning is not necessary, skip step 9 and go to step 10.
9	<pre> RUN      - Vib Sup - freq = 0420 Hz damp = 0120_                     </pre>	   	Select the digit with the  or  Key, and press the  or  Key to fine-tune the frequency.
10	<pre> RUN      - Vib Sup - freq = 0420 Hz damp = 0120_                     </pre>		Press the  Key to save the settings. "DONE" will flash for approximately two seconds and "RUN" will be displayed.
11	<pre> RUN      -FUNCTION- Fn203: OnePrmTun Fn204: A-Vib Sup Fn205: Vib Sup Fn206: Easy FFT                     </pre>		Press the  Key to complete the anti-resonance control adjustment function. The screen in step 1 will appear again.









■ With Determined Vibration Frequency

Step	Display after Operation	Keys	Operation
1	<pre> RUN      -FUNCTION- Fn203:OnePrmTun Fn204:A-Vib Sup Fn205:Vib Sup Fn206:Easy FFT                     </pre>	  	<p>Press the  Key to view the main menu for the utility function.</p> <p>Use the  or  Key to move through the list, select Fn204.</p>
2	<pre> RUN      -Vib Sup- Tuning Mode = 0                     </pre>		<p>Press the  Key to display the tuning mode selection screen for Fn204 (anti-resonance control adjustment function).</p>
3	<pre> RUN      -FUNCTION- Tuning Mode = 1                     </pre>	 	<p>Press the  or  Key and set the tuning mode "1."</p>
4	<pre> RUN      -Vib Sup- freq = 0100 Hz damp = 0000                     </pre>		<p>Press the  Key while "Tuning Mode = 1" is displayed. The screen shown on the left will appear and "freq" will flash.</p>  <p>Example of measured waveform</p>
5	<pre> RUN      -Vib Sup- freq = 0100 Hz damp = 0000                     </pre>	   	<p>Select the digit with the  or  Key, and press the  or  Key to adjust the frequency.</p>
6	<pre> RUN      -Vib Sup- freq = 0400 Hz damp = 000<u>0</u>                     </pre>		<p>Press the  Key. The cursor will move to "damp."</p>























(cont'd)

Step	Display after Operation	Keys	Operation
7	<pre> RUN      - Vib Sup - freq = 0400 Hz damp = 0020 </pre>		<p>Select the digit with the  or  Key, and press the  or  Key to adjust the damping gain.</p>  <p>Example of measured waveform</p> <p>Note: Increase the damping gain from about 0 to 200% in 10% increments while checking the effect of vibration reduction. If vibration reduction is still insufficient at a gain of 200%, cancel the setting, and lower the control gain by using a different method, such as one-parameter tuning.</p>
8	<pre> RUN      - Vib Sup - freq = 0400 Hz damp = 0120 </pre>		<p>If fine tuning of the frequency is necessary, press the  Key. The cursor will move from "damp" to "freq." If fine-tuning is not necessary, skip step 9 and go to step 10.</p>
9	<pre> RUN      - Vib Sup - freq = 0400 Hz damp = 0120 </pre>		<p>Select the digit with the  or  Key, and press the  or  Key to fine-tune the frequency.</p>
10	<pre> RUN      - Vib Sup - freq = 0400 Hz damp = 0120 </pre>		<p>Press the  Key to save the settings. "DONE" will flash for approximately two seconds and "RUN" will be displayed.</p>
11	<pre> RUN      -FUNCTION- Fn203: OnePrmTun Fn204: A-Vib Sup Fn205: Vib Sup Fn206: Easy FFT </pre>		<p>Press the  Key to complete the anti-resonance control adjustment function. The screen in step 1 will appear again.</p>

## (2) For Fine-tuning After Adjusting the Anti-Resonance Control

Step	Display after Operation	Keys	Operation
1	<pre> RUN      -FUNCTION- Fn203: OnePrmTun Fn204: A-Vib Sup Fn205: Vib Sup Fn206: Easy FFT </pre>	 	<p>Press the  Key to view the main menu for the utility function.</p> <p>Use the  or  Key to move through the list, select Fn204.</p>
2	<pre> RUN      -FUNCTION- Tuning Mode = 1 </pre>		<p>Press the  Key to display the "Tuning Mode = 1" as shown on the left.</p>
3	<pre> RUN      - Vib Sup - freq = 0400 Hz damp = 0120 </pre>		<p>Press the  Key while "Tuning Mode = 1" is displayed. The screen shown on the left will appear and "damp" will flash.</p>

(cont'd)

Step	Display after Operation	Keys	Operation
4	<pre> RUN      - V i b S u p - freq = 0400 Hz damp = 01<u>5</u>0                     </pre>	   	Select the digit with the  or  Key, and press the  or  Key to set the damping gain. Note: Increase the damping gain from about 0 to 200% in 10% increments while checking the effect of vibration reduction. If vibration reduction is still insufficient at a gain of 200%, cancel the setting, and lower the control gain by using a different method, such as one-parameter tuning.
5	<pre> RUN      - V i b S u p - freq = 040<u>0</u> Hz damp = 0150                     </pre>		If fine tuning of the frequency is necessary, press the  Key. The cursor will move from "damp" to "freq." If fine-tuning is not necessary, skip step 6 and go to step 7.
6	<pre> RUN      - V i b S u p - freq = 04<u>2</u>0 Hz damp = 0150                     </pre>	   	Select the digit with the  or  Key, and press the  or  Key to fine-tune the frequency.
7	<pre> RUN      - V i b S u p - freq = 0420 Hz damp = 015<u>0</u>                     </pre>		Press the  Key to save the settings. "DONE" will flash for approximately two seconds and "RUN" will be displayed.
8	<pre> RUN      -FUNCTION- Fn203: OnePrmTun Fn204: A-Vib Sup Fn205: Vib Sup Fn206: Easy FFT                     </pre>		Press the  Key to complete the anti-resonance control adjustment function. The screen in step 1 will appear again.

### 5.6.3 Related Parameters

The following table lists parameters related to this function and their possibility of being changed while executing this function or of being changed automatically after executing this function.

- Parameters related to this function
  - These are parameters that are used or referenced when executing this function.
- Allowed changes during execution of this function
  - Yes : Parameters can be changed using SigmaWin+ while this function is being executed.
  - No : Parameters cannot be changed using SigmaWin+ while this function is being executed.
- Automatic changes after execution of this function
  - Yes : Parameter set values are automatically set or adjusted after execution of this function.
  - No: Parameter set values are not automatically set or adjusted after execution of this function.

Parameter	Name	Mid-execution changes	Automatic changes
<b>Pn160</b>	Anti-Resonance Control Related Switch	Yes	Yes
<b>Pn161</b>	Anti-Resonance Frequency	No	Yes
<b>Pn162</b>	Anti-Resonance Gain Compensation	Yes	No
<b>Pn163</b>	Anti-Resonance Damping Gain	No	Yes
<b>Pn164</b>	Anti-Resonance Filter Time Constant 1 Compensation	Yes	No
<b>Pn165</b>	Anti-Resonance Filter Time Constant 2 Compensation	Yes	No

## 5.7 Vibration Suppression Function (Fn205)

The vibration suppression function is described in this section.

### 5.7.1 Vibration Suppression Function

The vibration suppression function suppresses transitional vibration at frequency as low as 1 to 100 Hz that is generated mainly when positioning if the machine stand vibrates.

This function is set automatically when advanced autotuning or advanced autotuning by reference is executed. In most cases, this function is not necessary. Use this function only if fine-tuning is required or readjustment is required as a result of a failure to detect vibration.

Perform one-parameter tuning (Fn203) if required to improve the response characteristics after performing this function.

#### CAUTION

- If this function is executed, related parameters will be set automatically. Therefore, there will be a large response change after this function is enabled or disabled. Enable the function in a state where the machine can come to an emergency stop at any time to ensure the safety operation of the machine.
- Be sure to set a suitable value for the mass ratio (Pn103) using advanced autotuning before executing the vibration suppression function. If the setting greatly differs from the actual mass ratio, normal control of the SERVOPACK may not be possible, and vibration may result.



#### IMPORTANT

- This function detects vibration frequency between 1 to 100 Hz. Vibration will not be detected for frequencies outside of this range, and instead, "F-----" will be displayed.
- Frequency detection will not be performed if no vibration results from position error or the vibration frequencies are outside the range of detectable frequencies. If so, use a device, such as a displacement sensor or vibration sensor, to measure the vibration frequency.
- If vibration frequencies automatically detected are not suppressed, the actual frequency and the detected frequency may differ. Fine-tune the detected frequency if necessary.

#### (1) Preparation

Check the following settings before performing the vibration suppression function.

The message "NO-OP" indicating that the settings are not appropriate will be displayed, if all of the following conditions are not met.

- The control must be set to position control.
- The tuning-less function must be disabled (Pn170.0 = 0).
- The test without a motor function must be disabled (Pn00C.0 = 0).
- The write prohibited setting (Fn010) must be set to Write permitted (P.0000).

#### (2) Items Influencing Performance

If continuous vibration occurs when the servomotor is not moving, the vibration suppression function cannot be used to suppress the vibration effectively. If the result is not satisfactory, perform anti-resonance control adjustment function (Fn204) or one-parameter tuning (Fn203).

#### (3) Detection of Vibration Frequencies

Frequency detection may not be possible if there is not enough vibration to affect the position error or the effect on the position error is minimal. The detection sensitivity can be adjusted by changing the setting for the remained vibration detection width (Pn560), which is set as a percentage of the positioning completed width (Pn522). Perform detection of vibration frequencies again after adjusting the remained vibration detection width (Pn560).

Pn560	Remained Vibration Detection Width <span style="border: 1px solid black; padding: 0 5px;">Position</span>				Classification
	Setting Range	Setting Unit	Factory Setting	When Enabled	
	1 to 3000	0.1%	400	Immediately	Setup

Note: As a guideline, change the setting 10% at a time. The smaller the set value is, the higher the detection sensitivity will be. If the value is too small, however, the vibration may not be detected accurately.

The vibration frequencies that are automatically detected may vary somewhat with each positioning operation. Perform positioning several times and make adjustments while checking the effect of vibration suppression.

## 5.7.2 Vibration Suppression Function Operating Procedure

The following procedure is used for vibration suppression function.

Vibration suppression function is performed from the digital operator (option) or SigmaWin+.

The operating procedure from the digital operator is described here.

Refer to the  *$\Sigma$ -V Series User's Manual, Operation of Digital Operator* (No.: SIEP S800000 55) for basic key operations of the digital operator.







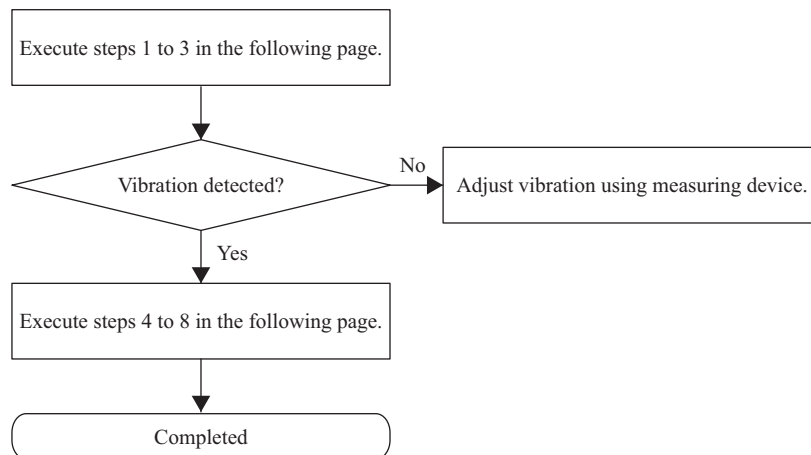









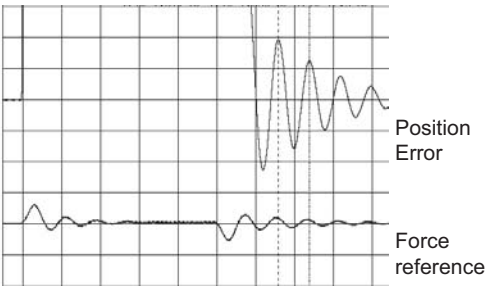

Note: If this function is aborted by pressing the MODE/SET Key, the SERVOPACK will continue operating until the servomotor comes to a stop. After the servomotor stops, the set value will return to the previous value.

The operating flow of the vibration suppression function is shown below.







### (1) Operating Flow

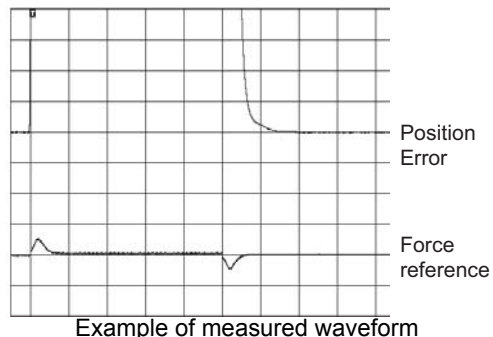

(2) Operating Procedure

Step	Display after Operation	Keys	Operation
1	Input a operation reference and take the following steps while repeating positioning.		
2	<pre> RUN      -FUNCTION- Fn204:A-Vib Sup Fn205:Vib Sup Fn206:Easy FFT Fn207:V-Monitor                     </pre>	  	<p>Press the  Key to view the main menu for the utility function.</p> <p>Use the  or  Key to move through the list, select Fn205.</p>
3	<pre> RUN      -Vib Sup- Measure f=010.4Hz Setting f=050.4Hz                     </pre>		<p>Press the  Key. The display shown on the left will appear.</p> <p>Measure f: Measurement frequency  Setting f: Setting frequency [Factory-set to the set value for Pn145]</p> <p>If the setting frequency and actual operating frequency are different, "Setting" will flash.</p> <p>Note: Frequency detection will not be performed if there is no vibration or the vibration frequency is outside the range of detectable frequencies. The following screen will be displayed if vibration is not detected. If the vibration frequencies are not detected, prepare a means of detecting and measuring the vibration. When the vibration frequencies are measured, go to step 5 and manually set the measured vibration frequency to "Setting f."</p> <pre> RUN      -Vib Sup- Measure f=-----Hz Setting f=050.0Hz                     </pre>
4	<pre> RUN      -Vib Sup- Measure f=010.4Hz Setting f=010.4Hz                     </pre>		<p>Press the  Key. The displayed "Measure f" value will be displayed as the "Setting f" value as well.</p>  <p>Example of measured waveform</p>
5	<pre> RUN      -Vib Sup- Measure f=010.4Hz Setting f=012.4Hz                     </pre>	   	<p>If the vibration is not completely suppressed, select the digit with the  or  Key, and press the  or  Key to fine-tune the frequency "setting f." Skip this step and go to step 7 if the fine-tuning of the frequency is not necessary.</p> <p>Note: If the setting frequency and actual operating frequency are different, "Setting" will flash.</p>

(cont'd)

Step	Display after Operation	Keys	Operation
6	<pre> RUN      -Vib Sup- Measure f=010.4Hz Setting f=012.4Hz                     </pre>		<p>Press the  Key. The "Setting f" will change to usual display and the frequency currently displayed will be set for the vibration suppression function.</p>  <p>Example of measured waveform</p>
7	<pre> RUN      -Vib Sup- Measure f=-----Hz Setting f=012.4Hz                     </pre>		<p>Press the  Key to save the setting. "DONE" will flash for approximately two seconds and "RUN" will be displayed again.</p>
8	<pre> RUN      -FUNCTION- Fn204 Fn205 Fn206 Fn207                     </pre>		<p>Press the  Key to complete the vibration suppression function. The screen in step 1 will appear again.</p>



**IMPORTANT**

No settings related to the vibration suppression function will be changed during operation.

If the servomotor does not stop approximately 10 seconds after the setting changes, a timeout error will result and the previous setting will be automatically enabled again.

The vibration suppression function will be enabled in step 6. The motor response, however, will change when the servomotor comes to a stop with no reference input.

### (3) Related Function on Vibration Suppression Function

This section describes functions related to vibration suppression function.

#### ■ Feedforward

The factory settings disable the feedforward gain (Pn109), speed feedforward input, and force feedforward input.

Set Pn140.3 to 1 if model following control is used together with the speed feedforward input and force feedforward input from the host controller via the command option module.

Parameter	Function	When Enabled	Classification
<b>Pn140</b>	n.0□□□ [Factory setting]	Immediately	Tuning
	n.1□□□		

For the force feedforward input and speed feedforward input, refer to the manual for the connected command option module.

**IMPORTANT**

Model following control is used to make optimum feedforward settings in the SERVO-PACK when model following control is used with the feedforward function. Therefore, model following control is not normally used together with either the speed feedforward input or force feedforward input from the host controller. However, model following control can be used with the speed feedforward input or force feedforward input if required. An improper feedforward input may result in overshooting.

### 5.7.3 Related Parameters

The following table lists parameters related to this function and their possibility of being changed while executing this function or of being changed automatically after executing this function.

- Parameters related to this function

These are parameters that are used or referenced when executing this function.

- Allowed changes during execution of this function

Yes: Parameters can be changed using SigmaWin+ while this function is being executed.

No: Parameters cannot be changed using SigmaWin+ while this function is being executed.

- Automatic changes after execution of this function

Yes: Parameter set values are automatically set or adjusted after execution of this function.

No: Parameter set values are not automatically set or adjusted after execution of this function.

Parameter	Name	Mid-execution changes	Automatic changes
<b>Pn140</b>	Model Following Control Related Switch	Yes	Yes
<b>Pn141</b>	Model Following Control Gain	No	Yes
<b>Pn142</b>	Model Following Control Gain Compensation	No	No
<b>Pn143</b>	Model Following Control Bias (Forward Direction)	No	No
<b>Pn144</b>	Model Following Control Bias (Reverse Direction)	No	No
<b>Pn145</b>	Vibration Suppression 1 Frequency A	No	Yes
<b>Pn146</b>	Vibration Suppression 1 Frequency B	No	Yes
<b>Pn147</b>	Model Following Control Speed Feedforward Compensation	No	No
<b>Pn14A</b>	Vibration Suppression 2 Frequency	No	No
<b>Pn14B</b>	Vibration Suppression 2 Compensation	No	No

## 5.8 Additional Adjustment Function

This section describes the functions that can be used for additional fine tuning after making adjustments with advanced autotuning, advanced autotuning by reference, or one-parameter tuning.

- Switching gain settings
- Friction compensation
- Current control mode selection
- Current gain level setting
- Speed detection method selection

### 5.8.1 Switching Gain Settings

Two gain switching functions are available, manual switching and automatic switching. The manual switching function uses an external input signal to switch gains, and the automatic switching function switches gains automatically.

By using the gain switching function, the positioning time can be shortened by increasing the gain during positioning and vibration can be suppressed by decreasing the gain while it is stopped.

Parameter		Function	When Enabled	Classification
Pn139	n.□□□0 [Factory setting]	Manual gain switching	Immediately	Tuning
	n.□□□2	Automatic gain switching		

Note: n.□□□1 is reserved. Do not use.

For the gain combinations for switching, refer to (1) *Gain Combinations for Switching*.

For the manual gain switching, refer to the manual of the connected command option module.

For the automatic gain switching, refer to (3) *Automatic Gain Switching*.

#### (1) Gain Combinations for Switching

Setting	Speed Loop Gain	Speed Loop Integral Time Constant	Position Loop Gain	Force Reference Filter	Model Following Control Gain	Model Following Control Gain Compensation	Friction Compensation Gain
Gain Setting 1	Pn100 Speed Loop Gain	Pn101 Speed Loop Integral Time Constant	Pn102 Position Loop Gain	Pn401 Force Reference Filter Time Constant	Pn141* Model Following Control Gain	Pn142* Model Following Control Gain Compensation	Pn121 Friction Compensation Gain
Gain Setting 2	Pn104 2nd Speed Loop Gain	Pn105 2nd Speed Loop Integral Time Constant	Pn106 2nd Position Loop Gain	Pn412 1st Step 2nd Force Reference Filter Time Constant	Pn148* 2nd Model Following Control Gain	Pn149* 2nd Model Following Control Gain Compensation	Pn122 2nd Gain for Friction Compensation

\* The switching gain settings for the model following control gain and the model following control gain compensation are supported only for manual gain switching. To enable the gain switching of these parameters, a gain switching input signal must be sent, and the following conditions must be met.

- No command being executed.
- Motor having been completely stopped.

If these conditions are not satisfied, the applicable parameters will not be switched although the other parameters shown in this table will be switched.

## (2) Manual Gain Switching

Manual gain switching uses the gain switching command from the command option module to switch between gain settings 1 and gain settings 2.

For details, refer to the manual of the connected command option module.

## (3) Automatic Gain Switching

Automatic gain switching is enabled only in position control. The switching conditions are specified using the following settings.

Parameter Setting		Switching Condition	Setting	Switching Wait Time	Switching Time
<b>Pn139</b>	n.□□□2	Condition A satisfied.	Gain setting 1 to gain setting 2	Pn135 Gain Switching Waiting Time 1	Pn131 Gain Switching Time 1
		Condition A not satisfied.	Gain setting 2 to gain setting 1	Pn136 Gain Switching Waiting Time 2	Pn132 Gain Switching Time 2

Select one of the following settings for switching condition A.

Parameter		Switching Condition A for Position Control	For Other than Position Control (No Switching)	When Enabled	Classification
<b>Pn139</b>	n.□□0□ [Factory setting]	Positioning completed signal (/COIN) ON	Fixed in gain setting 1	Immediately	Tuning
	n.□□1□	Positioning completed signal (/COIN) OFF	Fixed in gain setting 2		
	n.□□2□	Positioning near signal (/NEAR) ON	Fixed in gain setting 1		
	n.□□3□	Positioning near signal (/NEAR) OFF	Fixed in gain setting 2		
	n.□□4□	No output for position reference filter and position reference input OFF	Fixed in gain setting 1		
	n.□□5□	Position reference input ON	Fixed in gain setting 2		

Automatic Switching Pattern 1 (Pn139 = n.□□□2)

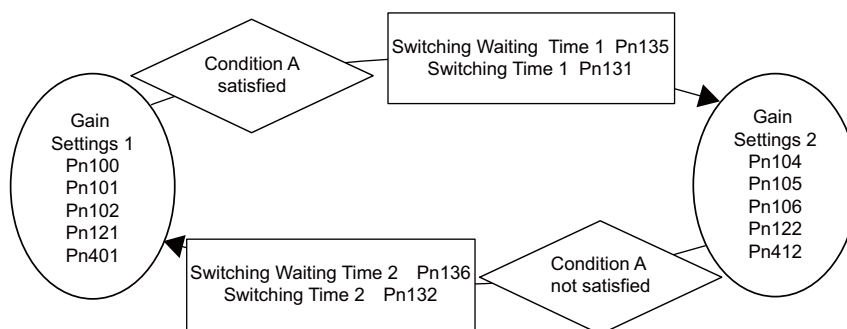

### ■ Relationship between the Waiting and Switching Times for Gain Switching

In this example, the "positioning completed signal (/COIN) ON" condition is set as condition A for automatic gain switching. The position loop gain is switched from the value in Pn102 (position loop gain) to the value in Pn106 (2nd position loop gain). When the /COIN signal goes ON, the switching operation begins after the waiting time set in Pn135. The switching operation changes the position loop gain linearly from Pn102 to Pn106 within the switching time set in Pn131.

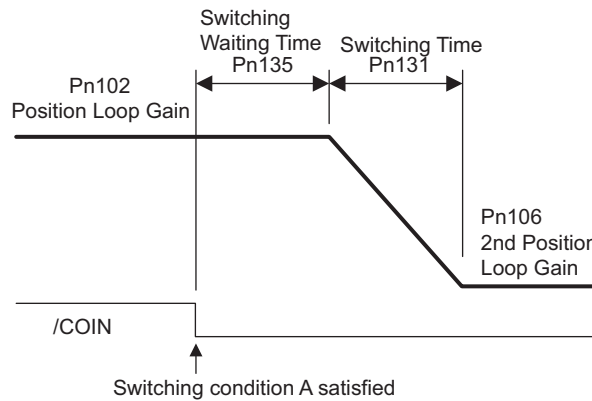

Note: Automatic gain switching is available in the PI and I-P controls (Pn10B).

#### (4) Related Parameters

Pn100	Speed Loop Gain <span style="float:right">Speed <input type="checkbox"/> Position <input type="checkbox"/></span>				Classification
	Setting Range	Setting Unit	Factory Setting	When Enabled	
	10 to 20000	0.1 Hz	400	Immediately	Tuning
Pn101	Speed Loop Integral Time Constant <span style="float:right">Speed <input type="checkbox"/> Position <input type="checkbox"/></span>				Classification
	Setting Range	Setting Unit	Factory Setting	When Enabled	
	15 to 51200	0.01 ms	2000	Immediately	Tuning
Pn102	Position Loop Gain <span style="float:right">Position <input type="checkbox"/></span>				Classification
	Setting Range	Setting Unit	Factory Setting	When Enabled	
	10 to 20000	0.1/s	400	Immediately	Tuning
Pn401	Force Reference Filter Time Constant <span style="float:right">Speed <input type="checkbox"/> Position <input type="checkbox"/> Force <input type="checkbox"/></span>				Classification
	Setting Range	Setting Unit	Factory Setting	When Enabled	
	0 to 65535	0.01 ms	100	Immediately	Tuning
Pn141	Model Following Control Gain <span style="float:right">Position <input type="checkbox"/></span>				Classification
	Setting Range	Setting Unit	Factory Setting	When Enabled	
	10 to 20000	0.1/s	500	Immediately	Tuning
Pn142	Model Following Control Gain Compensation <span style="float:right">Position <input type="checkbox"/></span>				Classification
	Setting Range	Setting Unit	Factory Setting	When Enabled	
	500 to 2000	0.1%	1000	Immediately	Tuning
Pn121	Friction Compensation Gain <span style="float:right">Speed <input type="checkbox"/> Position <input type="checkbox"/></span>				Classification
	Setting Range	Setting Unit	Factory Setting	When Enabled	
	10 to 1000	1%	100	Immediately	Tuning
Pn104	2nd Speed Loop Gain <span style="float:right">Speed <input type="checkbox"/> Position <input type="checkbox"/></span>				Classification
	Setting Range	Setting Unit	Factory Setting	When Enabled	
	10 to 20000	0.1 Hz	400	Immediately	Tuning

(cont'd)

Pn105	2nd Speed Loop Integral Time Constant <span style="float:right">Speed Position</span>				Classification
	Setting Range	Setting Unit	Factory Setting	When Enabled	
	15 to 51200	0.01 ms	2000	Immediately	Tuning
Pn106	2nd Position Loop Gain <span style="float:right">Position</span>				Classification
	Setting Range	Setting Unit	Factory Setting	When Enabled	
	10 to 20000	0.1/s	400	Immediately	Tuning
Pn412	1st Step 2nd Force Reference Filter Time Constant <span style="float:right">Speed Position Force</span>				Classification
	Setting Range	Setting Unit	Factory Setting	When Enabled	
	0 to 65535	0.01 ms	100	Immediately	Tuning
Pn148	2nd Model Following Control Gain <span style="float:right">Position</span>				Classification
	Setting Range	Setting Unit	Factory Setting	When Enabled	
	10 to 20000	0.1/s	500	Immediately	Tuning
Pn149	2nd Model Following Control Gain Compensation <span style="float:right">Position</span>				Classification
	Setting Range	Setting Unit	Factory Setting	When Enabled	
	500 to 2000	0.1%	1000	Immediately	Tuning
Pn122	2nd Gain for Friction Compensation <span style="float:right">Speed Position</span>				Classification
	Setting Range	Setting Unit	Factory Setting	When Enabled	
	10 to 1000	1%	100	Immediately	Tuning

## (5) Parameters for Automatic Gain Switching

Pn131	Gain Switching Time 1 <span style="float:right">Position</span>				Classification
	Setting Range	Setting Unit	Factory Setting	When Enabled	
	0 to 65535	1 ms	0	Immediately	Tuning
Pn132	Gain Switching Time 2 <span style="float:right">Position</span>				Classification
	Setting Range	Setting Unit	Factory Setting	When Enabled	
	0 to 65535	1 ms	0	Immediately	Tuning
Pn135	Gain Switching Waiting Time 1 <span style="float:right">Position</span>				Classification
	Setting Range	Setting Unit	Factory Setting	When Enabled	
	0 to 65535	1 ms	0	Immediately	Tuning
Pn136	Gain Switching Waiting Time 2 <span style="float:right">Position</span>				Classification
	Setting Range	Setting Unit	Factory Setting	When Enabled	
	0 to 65535	1 ms	0	Immediately	Tuning

## (6) Related Monitor

Monitor No. (Un)	Name	Value	Remarks
Un014	Effective gain monitor	1	For gain setting 1
		2	For gain setting 2

Note: When using the tuning-less function, gain setting 1 is enabled.

Parameter No.	Analog Monitor	Name	Output Value	Remarks
Pn006 Pn007	n.□□0B	Effective gain monitor	1 V	Gain setting 1 is enabled.
			2 V	Gain setting 2 is enabled.

## 5.8.2 Manual Adjustment of Friction Compensation

Friction compensation rectifies the viscous friction change and regular load change.

The friction compensation function can be automatically adjusted with advanced autotuning (Fn201), advanced autotuning by reference input (Fn202), or one-parameter tuning (Fn203). This section describes the steps to follow if manual adjustment is required.

### (1) Required Parameter Settings

The following parameter settings are required to use friction compensation.

Parameter		Function			When Enabled	Classification
Pn408	n.0□□□ [Factory setting]	Does not use friction compensation.			Immediately	Setup
	n.1□□□	Uses friction compensation.				
Pn121	Friction Compensation Gain				<input type="checkbox"/> Speed <input type="checkbox"/> Position	Classification
	Setting Range	Setting Unit	Factory Setting	When Enabled		
	10 to 1000	1%	100	Immediately	Tuning	
Pn123	Friction Compensation Coefficient				<input type="checkbox"/> Speed <input type="checkbox"/> Position	Classification
	Setting Range	Setting Unit	Factory Setting	When Enabled		
	0 to 100	1%	0	Immediately	Tuning	
Pn124	Friction Compensation Frequency Correction				<input type="checkbox"/> Speed <input type="checkbox"/> Position	Classification
	Setting Range	Setting Unit	Factory Setting	When Enabled		
	-10000 to 10000	0.1 Hz	0	Immediately	Tuning	
Pn125	Friction Compensation Gain Correction				<input type="checkbox"/> Speed <input type="checkbox"/> Position	Classification
	Setting Range	Setting Unit	Factory Setting	When Enabled		
	1 to 1000	1%	100	Immediately	Tuning	

## (2) Operating Procedure for Friction Compensation

The following procedure is used for friction compensation.

CAUTION

- Before using friction compensation, set the mass ratio (Pn103) as accurately as possible. If the wrong mass ratio is set, vibration may result.

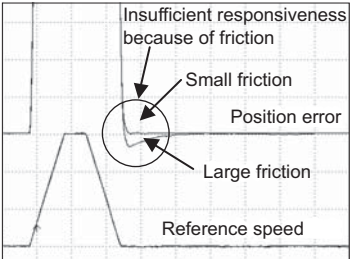
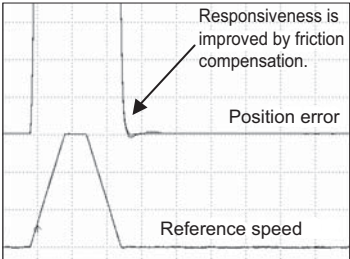
Step	Operation
1	<p>Set the following parameters for friction compensation to the factory setting as follows.                      Friction compensation gain (Pn121): 100                      Friction compensation coefficient (Pn123): 0                      Friction compensation frequency correction (Pn124): 0                      Friction compensation gain correction (Pn125): 100                      Note: Always use the factory-set values for friction compensation frequency correction (Pn124) and friction compensation gain correction (Pn125).</p>
2	<p>To check the effect of friction compensation, gradually increase the friction compensation coefficient (Pn123).                      Note: Usually, set the friction compensation coefficient value to 95% or less. If the effect is insufficient, increase the friction compensation gain (Pn121) by 10% increments until it stops vibrating.</p> <p><b>Effect of Parameters for Adjustment</b>                      Pn121: Friction Compensation Gain                      This parameter sets the responsiveness for external disturbance. The higher the set value is, the better the responsiveness will be. If the equipment has a resonance frequency, however, vibration may result if the set value is excessively high.</p> <p>Pn123: Friction Compensation Coefficient                      This parameter sets the effect of friction compensation. The higher the set value is, the more effective friction compensation will be. If the set value is excessively high, however, the vibration will occur easily. Usually, set the value to 95% or less.</p>
3	<p><b>Effect of Adjustment</b>                      The following graph shows the responsiveness with and without proper adjustment.</p> <div style="display: flex; justify-content: space-around; align-items: flex-start;"> <div style="text-align: center;">  <p>Without friction compensation</p> </div> <div style="text-align: center;">  <p>With friction compensation</p> </div> </div>

### 5.8.3 Current Control Mode Selection Function

This function reduces high-frequency noises while the servomotor is being stopped. This function is enabled by default and set to be effective under different application conditions. Set Pn009.1 = 1 to use this function.

This function can be used with the following SERVOPACKs.

Input Voltage	SERVOPACK Model SGDV-
200 V	120A, 180A, 200A, 330A, 550A
400 V	3R5D, 5R4D, 8R4D, 120D, 170D, 260D

Parameter	Meaning	When Enabled	Classification
Pn009	n. □□0□	After restart	Tuning
	n. □□1□ [Factory setting]		

	<ul style="list-style-type: none"> <li>If current control mode 2 is selected, the load ratio may increase while the servomotor is being stopped.</li> </ul>
<b>IMPORTANT</b>	

### 5.8.4 Current Gain Level Setting

This function reduces noises by adjusting the parameter value for current control inside the SERVOPACK according to the speed loop gain (Pn100). The noise level can be reduced by reducing the current gain level (Pn13D) from its factory setting of 2000% (disabled). If the set value of Pn13D is decreased, the level of noise will be lowered, but the response characteristics of the SERVOPACK will also be degraded. Adjust the current gain level within the allowable range at which SERVOPACK response characteristics can be secured.

Pn13D	Current Gain Level				Classification
	Setting Range	Setting Unit	Factory Setting	When Enabled	
	100 to 2000	1%	2000	Immediately	Tuning

	<ul style="list-style-type: none"> <li>If this parameter is changed, the response characteristics of the speed loop will also change, and the SERVOPACK may require readjustment.</li> </ul>
<b>IMPORTANT</b>	

### 5.8.5 Speed Detection Method Selection

The speed detection method selection can be used to smooth the speed of the servomotor during operation. To smooth the speed of the servomotor during operation, set Pn009 to n.□1□□ to select speed detection 2. When the scale pitch of the linear scale is large, the noise level of the running servomotor can be reduced.

Parameter	Meaning	When Enabled	Classification
Pn009	n. □0□□ [Factory setting]	After restart	Tuning
	n. □1□□		

	<ul style="list-style-type: none"> <li>If the speed detection method is changed, the response characteristics of the speed loop will also change, and the SERVOPACK may require readjustment.</li> </ul>
<b>IMPORTANT</b>	

## 5.9 Compatible Adjustment Function

The  $\Sigma$ -V series SERVOPACKs have adjustment functions as explained in sections 5.1 to 5.8 to make machine adjustments.

This section explains compatible functions provided by earlier models, such as the  $\Sigma$ -III Series SERVOPACK.

### 5.9.1 Feedforward Reference

This function applies feedforward compensation to position control and shortens positioning time.

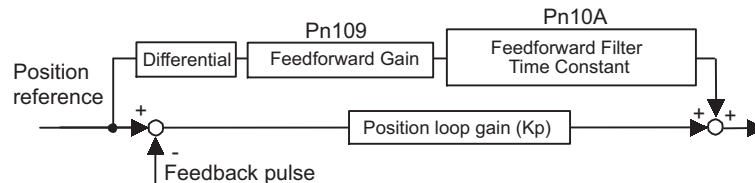

<b>Pn109</b>	Feedforward Gain <span style="float: right;">Position</span>				Classification
	Setting Range	Setting Unit	Factory Setting	When Enabled	
	0 to 100	1%	0	Immediately	Tuning
<b>Pn10A</b>	Feedforward Filter Time Constant <span style="float: right;">Position</span>				Classification
	Setting Range	Setting Unit	Factory Setting	When Enabled	
	0 to 6400	0.01 ms	0	Immediately	Tuning

Note: Too high value may cause the machine to vibrate. For ordinary machines, set 80% or less in this parameter.

## 5.9.2 Mode Switch (P/PI Switching)

The mode switch automatically switches between proportional and PI control. Set the switching condition with Pn10B.0 and set the level of detection points with Pn10C, Pn181, Pn182, and Pn10F.

Overshooting caused by acceleration and deceleration can be suppressed and the settling time can be reduced by setting the switching condition and detection points.

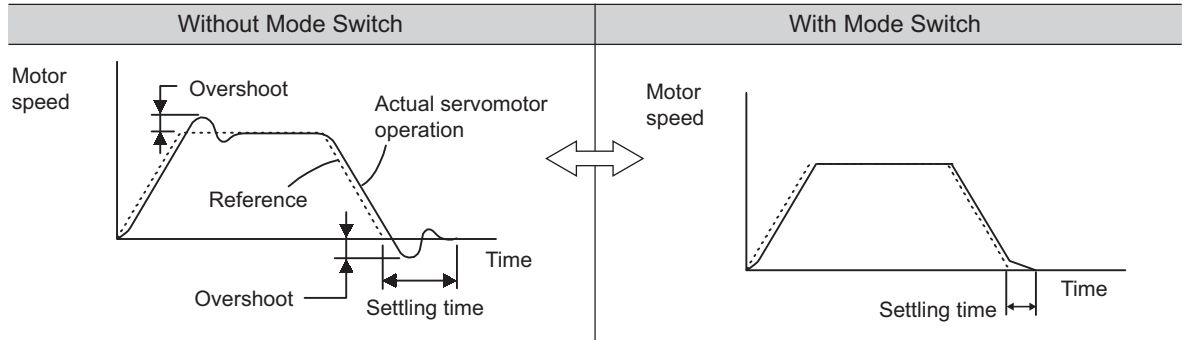

### (1) Related Parameters

Select the switching condition of the mode switch with Pn10B.0.

Parameter	Mode Switch Selection	Parameter Containing Detection Point Setting	When Enabled	Classification
Pn10B	n.□□□0 [Factory setting]	Uses an internal force reference level for the switching conditions.	Pn10C	Immediately Setup
	n.□□□1	Uses a speed reference level for the switching conditions.	Pn181	
	n.□□□2	Uses an acceleration level for the switching conditions.	Pn182	
	n.□□□3	Uses a position error level for the switching conditions.	Pn10F	
	n.□□□4	Does not use mode switch function.	—	

#### ■ Parameters to Set the Level of Detection Points

Pn10C	Mode Switch (Force Reference) <span style="float:right">Speed <input type="checkbox"/> Position <input type="checkbox"/></span>				Classification
	Setting Range	Setting Unit	Factory Setting	When Enabled	
	0 to 800	1%	200	Immediately	Tuning
Pn181	Mode Switch (Speed Reference) <span style="float:right">Speed <input type="checkbox"/> Position <input type="checkbox"/></span>				Classification
	Setting Range	Setting Unit	Factory Setting	When Enabled	
	0 to 10000	1 mm/s	0	Immediately	Tuning
Pn182	Mode Switch (Acceleration) <span style="float:right">Speed <input type="checkbox"/> Position <input type="checkbox"/></span>				Classification
	Setting Range	Setting Unit	Factory Setting	When Enabled	
	0 to 30000	1 mm/s <sup>2</sup>	0	Immediately	Tuning
Pn10F	Mode Switch (Position Error) <span style="float:right">Position <input type="checkbox"/></span>				Classification
	Setting Range	Setting Unit	Factory Setting	When Enabled	
	0 to 10000	1 reference unit	0	Immediately	Tuning

## (2) Operating Examples for Different Switching Conditions

### ■ Using the Force Reference [Factory Setting]

With this setting, the speed loop is switched to P control when the value of force reference input exceeds the force set in Pn10C. The factory setting for the force reference detection point is 200% of the rated force.

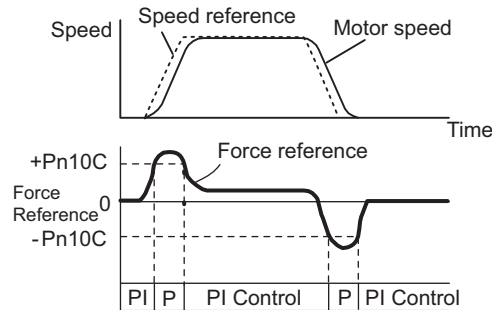

### ■ Using the Speed Reference

With this setting, the speed loop is switched to P control when the value of speed reference input exceeds the speed set in Pn181.

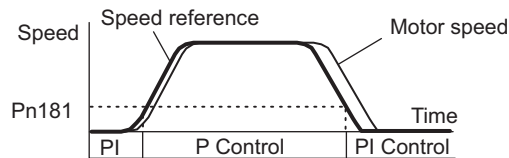

### ■ Using Acceleration

With this setting, the speed loop is switched to P control when the speed reference exceeds the acceleration set in Pn182.

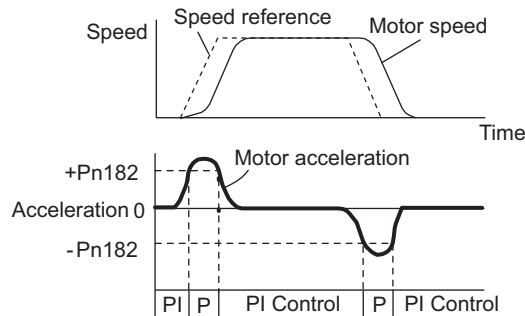

### ■ Using the Position Error

With this setting, the speed loop is switched to P control when the position error exceeds the value set in Pn10F.

This setting is effective with position control only.

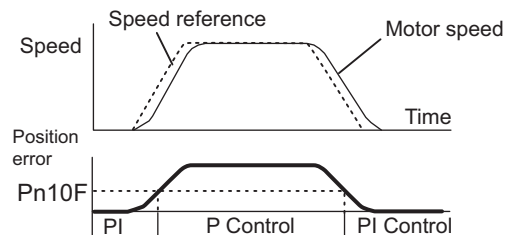

### 5.9.3 Force Reference Filter

As shown in the following diagram, the force reference filter contains first order lag filter and notch filters arrayed in series, and each filter operates independently. The notch filters can be enabled and disabled with the Pn408.

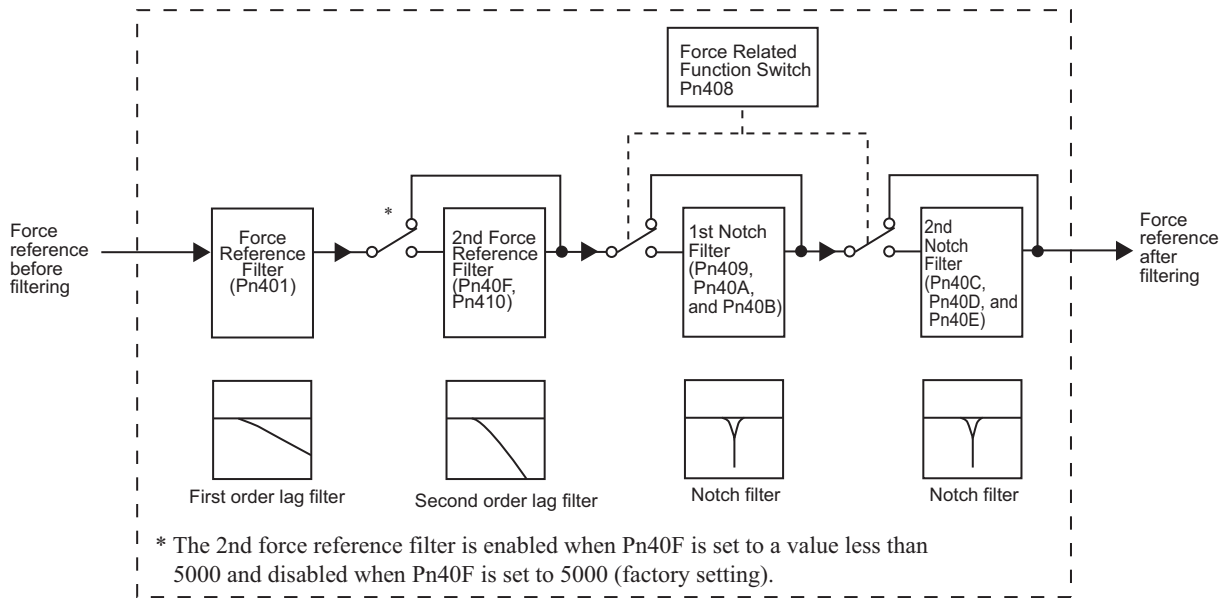

#### (1) Force Reference Filter

If you suspect that machine vibration is being caused by the servo drive, try adjusting the filter time constants with Pn401. This may stop the vibration. The lower the value, the better the response will be, but there may be a limit that depends on the machine conditions.

<b>Pn401</b>	Force Reference Filter Time Constant <span style="float:right">Speed Position Force</span>				Classification
	Setting Range	Setting Unit	Factory Setting	When Enabled	
	0 to 65535	0.01 ms	100	Immediately	

#### Force Reference Filter Setting Guide

Speed Loop Gain and Force Reference Filter Time Constant

Adjusted value for stable control:  $Pn401 [ms] \leq 1000 / (2\pi \times Pn100 [Hz] \times 4)$

Critical gains:  $Pn401 [ms] < 1000 / (2\pi \times Pn100 [Hz] \times 1)$

<b>Pn40F</b>	2nd Step 2nd Force Reference Filter Frequency <span style="float:right">Speed Position Force</span>				Classification
	Setting Range	Setting Unit	Factory Setting	When Enabled	
	100 to 5000	1 Hz	5000*	Immediately	

  

<b>Pn410</b>	2nd Step 2nd Force Reference Filter Q Value <span style="float:right">Speed Position Force</span>				Classification
	Setting Range	Setting Unit	Factory Setting	When Enabled	
	50 to 100	0.01	50	Immediately	

\* The filter is disabled if 5000 is set.

## (2) Notch Filter

The notch filter can eliminate specific frequency elements generated by the vibration of sources such as resonance of the machine. The notch filter puts a notch in the gain curve at the specific vibration frequency. The frequency characteristics near the notch can be reduced or removed with this filter. A higher Q value produces a sharper notch and phase delay.

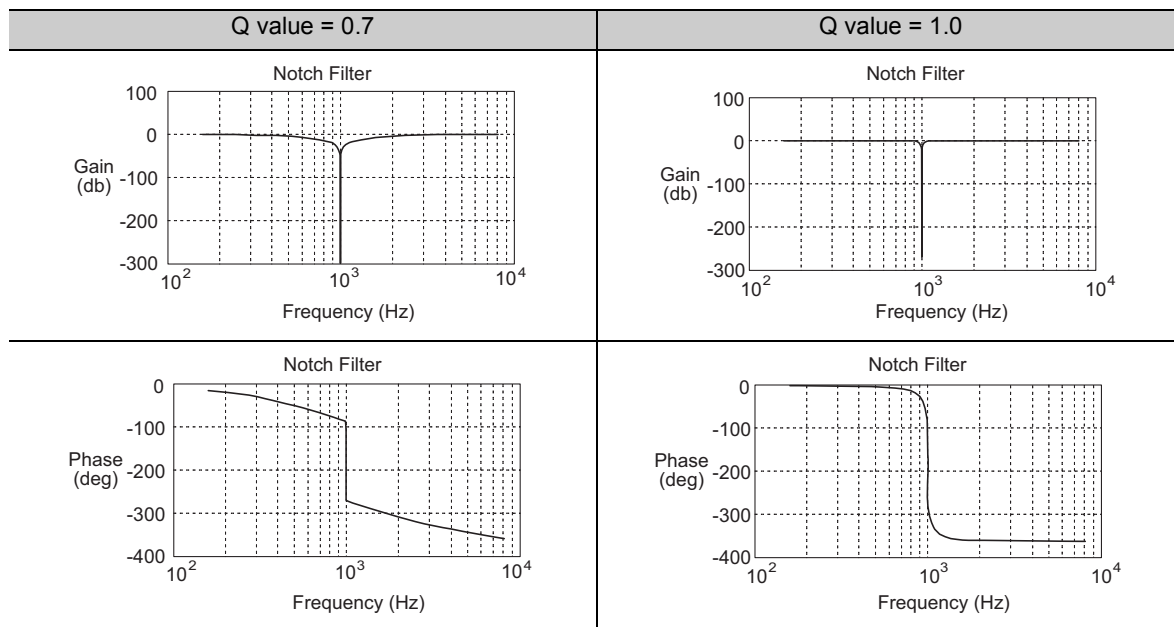

The notch filter can be enabled or disabled with Pn408.

Parameter	Meaning	When Enabled	Classification
<b>Pn408</b>	n.□□□0 [Factory setting]	Disables 1st notch filter.	Immediately Setup
	n.□□□1	Enables 1st notch filter.	
	n.□0□□ [Factory setting]	Disables 2nd notch filter.	
	n.□1□□	Enables 2nd notch filter.	

Set the machine's vibration frequency as a parameter of the notch filter.

<b>Pn409</b>	1st Notch Filter Frequency <span style="float:right">Speed Position Force</span>				Classification
	Setting Range	Setting Unit	Factory Setting	When Enabled	
	50 to 5000	1 Hz	5000	Immediately	Tuning
<b>Pn40A</b>	1st Notch Filter Q Value <span style="float:right">Speed Position Force</span>				Classification
	Setting Range	Setting Unit	Factory Setting	When Enabled	
	50 to 1000	0.01	70	Immediately	Tuning
<b>Pn40B</b>	1st Notch Filter Depth <span style="float:right">Speed Position Force</span>				Classification
	Setting Range	Setting Unit	Factory Setting	When Enabled	
	0 to 1000	0.001	0	Immediately	Tuning
<b>Pn40C</b>	2nd Notch Filter Frequency <span style="float:right">Speed Position Force</span>				Classification
	Setting Range	Setting Unit	Factory Setting	When Enabled	
	50 to 5000	1 Hz	5000	Immediately	Tuning

(cont'd)

<b>Pn40D</b>	2nd Notch Filter Q Value <span style="float:right">Speed   Position   Force</span>				Classification
	Setting Range	Setting Unit	Factory Setting	When Enabled	
	50 to 1000	0.01	70	Immediately	Tuning
<b>Pn40E</b>	2nd Notch Filter Depth <span style="float:right">Speed   Position   Force</span>				Classification
	Setting Range	Setting Unit	Factory Setting	When Enabled	
	0 to 1000	0.001	0	Immediately	Tuning

**IMPORTANT**

- Sufficient precautions must be taken when setting the notch filter frequencies. Do not set the notch filter frequencies (Pn409 or Pn40C) that is close to the speed loop's response frequency. Set the frequencies at least four times higher than the speed loop's response frequency. Setting the notch filter frequency too close to the response frequency may cause vibration and damage the machine.
- Change the notch filter frequencies (Pn409 or Pn40C) only when the servomotor is stopped. Vibration may occur if the notch filter frequency is changed when the servomotor is moving.

### 5.9.4 Position Integral

The position integral is the integral function of the position loop.

<b>Pn11F</b>	Position Integral Time Constant <span style="float:right">Position</span>				Classification
	Setting Range	Setting Unit	Factory Setting	When Enabled	
	0 to 50000	0.1 ms	0	Immediately	Tuning

## Utility Functions (Fn□□□)

6.1 List of Utility Functions .....	6-2
6.2 Alarm History Display (Fn000) .....	6-3
6.3 JOG Operation (Fn002) .....	6-4
6.4 Origin Search (Fn003) .....	6-6
6.5 Program JOG Operation (Fn004) .....	6-8
6.6 Initializing Parameter Settings (Fn005) .....	6-12
6.7 Clearing Alarm History (Fn006) .....	6-13
6.8 Offset Adjustment of Analog Monitor Output (Fn00C) .....	6-14
6.9 Gain Adjustment of Analog Monitor Output (Fn00D) .....	6-16
6.10 Automatic Offset-Signal Adjustment of the Motor Current Detection Signal (Fn00E) .....	6-18
6.11 Manual Offset-Signal Adjustment of the Motor Current Detection Signal (Fn00F) .....	6-19
6.12 Write Prohibited Setting (Fn010) .....	6-21
6.13 Servomotor Model Display (Fn011) .....	6-23
6.14 Software Version Display (Fn012) .....	6-24
6.15 Resetting Configuration Errors in Option Modules (Fn014) .....	6-25
6.16 Vibration Detection Level Initialization (Fn01B) .....	6-26
6.17 Display of SERVOPACK and Servomotor ID (Fn01E) .....	6-28
6.18 Origin Setting (Fn020) .....	6-30
6.19 Software Reset (Fn030) .....	6-31
6.20 Polarity Detection (Fn080) .....	6-32
6.21 EasyFFT (Fn206) .....	6-33
6.22 Online Vibration Monitor (Fn207) .....	6-36

## 6.1 List of Utility Functions

Utility functions are used to execute the functions related to servomotor operation and adjustment. Each utility function has a number starting with Fn.

The following table lists the utility functions and reference section.

Function No.	Function	Reference Section
Fn000	Alarm history display	6.2
Fn002	JOG operation	6.3
Fn003	Origin search	6.4
Fn004	Program JOG operation	6.5
Fn005	Initializing parameter settings	6.6
Fn006	Clearing alarm history	6.7
Fn00C	Offset adjustment of analog monitor output	6.8
Fn00D	Gain adjustment of analog monitor output	6.9
Fn00E	Automatic offset-signal adjustment of the motor current detection signal	6.10
Fn00F	Manual offset-signal adjustment of the motor current detection signal	6.11
Fn010	Write prohibited setting	6.12
Fn011	Servomotor model display	6.13
Fn012	Software version display	6.14
Fn014	Resetting configuration error in option modules	6.15
Fn01B	Vibration detection level initialization	6.16
Fn01E	Display of SERVOPACK and servomotor ID	6.17
Fn020	Origin setting	6.18
Fn030	Software reset	6.19
Fn080	Polarity Detection	6.20
Fn200	Tuning-less levels setting	5.2.2
Fn201	Advanced autotuning	5.3.2
Fn202	Advanced autotuning by reference	5.4.2
Fn203	One-parameter tuning	5.5.2
Fn204	Anti-resonance control adjustment function	5.6.2
Fn205	Vibration suppression function	5.7.2
Fn206	EasyFFT	6.21
Fn207	Online vibration monitor	6.22

Note: Execute the utility function with either a digital operator or SigmaWin+. If they are used together, "no\_oP" or "NO-OP" will be displayed when the utility function is executed.

## 6.2 Alarm History Display (Fn000)

This function displays the last ten alarms that have occurred in the SERVOPACK.

The latest ten alarm numbers and time stamps\* can be checked.

\* Time Stamps

A function that measures the ON times of the control power supply and main circuit power supply in 100-ms units and displays the total operating time when an alarm occurs. The time stamp operates around the clock for approximately 13 years.

<Example of Time Stamps>

If 36000 is displayed,

$3600000 \text{ [ms]} = 3600 \text{ [s]} = 60 \text{ [min]} = 1 \text{ [h]}$

















Therefore, the total number of operating hours is 1 hour.

### (1) Preparation

There are no tasks that must be performed before displaying the alarm history.

### (2) Operating Procedure

Use the following procedure.

Step	Display after Operation	Keys	Operation
1	<pre> BB          - FUNCTION - Fn207:V-Monitor Fn000:Alm History Fn002:JOG Fn003:Z-Search           </pre>	  	Press the  Key to view the main menu for the utility function. Use the  or  Key to move through the list and select Fn000.
2	<pre> A.D00      - ALARM - 0:D00      00001207196 1:720      00000032651 2:511      00000009043 3:---           </pre>		Press the  Key. The display changes to the Fn000 execution display.
3	<pre> A.D00      - ALARM - 1:720      00000032651 2:511      00000009043 3:--- 4:---           </pre> <p>   </p> <p>           Time stamp            Alarm no.            Alarm history no.            0: Latest            9: Oldest         </p>	 	Press the  or  Key to scroll through the alarm history. The alarm history can be viewed.
4	<pre> BB          - FUNCTION - Fn207:V-Monitor Fn000:Alm History Fn002:JOG Fn003:Z-Search           </pre>		Press the  Key. The display returns to the main menu of the utility function.

<NOTE>

- If the same alarm occurs after more than one hour, the alarm will be saved. If it occurs in less than one hour, it will not be saved.
- If no alarm has occurred, “□:---” will be displayed on the digital operator.
- Delete the alarm history using the parameter Fn006. The alarm history is not cleared on alarm reset or when the SERVOPACK main circuit power is turned OFF.

## 6.3 JOG Operation (Fn002)

JOG operation is used to check the operation of the servomotor under speed control without connecting the SERVOPACK to the host controller.

### CAUTION

- While the SERVOPACK is in JOG operation, the overtravel function will be disabled. Consider the operating range of the machine when performing JOG operation for the SERVOPACK.

#### (1) Preparation























The following conditions must be met to perform a jog operation.

- The write prohibited setting (Fn010) must be set to Write permitted (P.0000).
- The main circuit power supply must be ON.
- All alarms must be cleared.
- The hardwire baseblock (HWBB) must be disabled.
- The servomotor power must be OFF.
- The JOG speed must be set considering the operating range of the machine.  
Set the jog speed in Pn383.











Pn383	Jog Speed				Classification
	Setting Range	Setting Unit	Factory Setting	When Enabled	
	0 to 10000	1 mm/s	50	Immediately	

#### (2) Operating Procedure

Use the following procedure. The following example is for when the moving direction of the servomotor is set as Pn000.0 = 0 (Sets the linear scale counting up direction as the forward direction).

Step	Display after Operation	Keys	Operation
1	<pre> BB          -FUNCTION- Fn000:Alm History Fn002:JOG Fn003:Z-Search Fn004:Program JOG           </pre>	  	<p>Press the  Key to view the main menu for the utility function.</p> <p>Use the  or  Key to move through the list and select Fn002.</p>
2	<pre> BB          -JOG- Pn383=00500 Un000= 00000 Un002= 00000 Un00D= 0000000000           </pre>		<p>Press the  Key. The display changes to the Fn002 execution display.</p>
3	<pre> BB          -JOG- Pn383=0050<u>0</u> Un000= 00000 Un002= 00000 Un00D= 0000000000           </pre>		<p>Press the  Key to move the cursor to the setting side of Pn383 (JOG Speed).</p>
4	<pre> BB          -JOG- Pn383=01<u>0</u>00 Un000= 00000 Un002= 00000 Un00D= 0000000000           </pre>	   	<p>Press the  or  Key and the  or  Key to set the JOG speed (Pn383) to 1000 mm/s.</p>
5	<pre> BB          -JOG- Pn383=01000 Un000= 00000 Un002= 00000 Un00D= 0000000000           </pre>		<p>Press the  Key.</p> <p>The setting value is entered, and the cursor moves to the parameter number side (the left side).</p>
6	<pre> RUN        -JOG- Pn383=01000 Un000= 00000 Un002= 00000 Un00D= 0000000000           </pre>		<p>Press the  Key.</p> <p>The status display changes from "BB" to "RUN", and the servomotor power turns ON.</p>

(cont'd)

Step	Display after Operation	Keys	Operation
7	<pre> RUN          - JOG - Pn383=01000 Un000= 00000 Un002= 00000 Un00D= 0000000000 </pre>	 	<p>The servomotor will move at the present speed set in Pn383 while the  Key (for forward run) or  Key (for reverse run) is pressed.</p>  Motor forward run  Motor reverse run
8	<pre> BB          - JOG - Pn383=01000 Un000= 00000 Un002= 00000 Un00D= 0000000000 </pre>		<p>After having confirmed the correct motion of servomotor, press the  Key.</p> <p>The status display changes from "RUN" to "BB", and the servomotor power turns OFF.</p>
9	<pre> BB          - FUNCTION - Fn000:Alm History Fn002:JOG Fn003:Z-Search Fn004:Program JOG </pre>		<p>Press the  Key.</p> <p>The display returns to the main menu of the utility function.</p>
10	To enable the setting, turn the power supply to the SERVOPACK OFF and ON again.		

## 6.4 Origin Search (Fn003)

The origin search is designed to position the origin pulse position of the incremental linear scale (phase C) and to clamp at the position.



### CAUTION

- The forward run prohibited (P-OT) and reverse run prohibited (N-OT) signals are not effective in origin search mode.

This function is used when the servomotor needs to be aligned to the machine.  
Motor speed at the time of execution: 15 mm/s



























### (1) Preparation

The following conditions must be met to perform the origin search.

- The write prohibited setting (Fn010) must be set to Write permitted (P.0000).
- The main circuit power supply must be ON.
- All alarms must be cleared.
- The hardwire baseblock (HWBB) must be disabled.
- The servomotor power must be OFF.

## (2) Operating Procedure

Use the following procedure.

Step	Display after Operation	Keys	Operation											
1	<pre> BB      -FUNCTION- Fn002:JOG Fn003:Z-Search Fn004:Program JOG Fn005:Prm Init           </pre>	  	<p>Press the  Key to view the main menu for the utility function.</p> <p>Use the  or  Key to move through the list and select Fn003.</p>											
2	<pre> BB      -Z-Search- Un000= 00000 Un002= 00000 Un003= 0000000774 Un00D= 0000000000           </pre>		<p>Press the  Key. The display changes to the Fn003 execution display.</p>											
3	<pre> RUN     -Z-Search- Un000= 00000 Un002= 00000 Un003= 0000000774 Un00D= 0000000000           </pre>		<p>Press the  Key.</p> <p>The status display changes from "BB" to "RUN", and the servomotor power turns ON.</p> <p>Note: If the servomotor is already at the zero position, "-Complete-" is displayed.</p>											
4	<pre> RUN     -Complete- Un000= 00000 Un002= 00000 Un003= 0000000000 Un00D= 0000001D58           </pre>	 	<p>Pressing the  Key will run the servomotor in the forward direction. Pressing the  Key will run the servomotor in the reverse direction. The movement direction of the servomotor changes according to the setting of Pn000.0 as shown in the following table.</p> <table border="1"> <thead> <tr> <th colspan="2">Parameter</th> <th> Key</th> <th> Key</th> </tr> </thead> <tbody> <tr> <td rowspan="2">Pn000</td> <td>n.□□□0</td> <td>Linear scale counting up</td> <td>Linear scale counting down</td> </tr> <tr> <td>n.□□□1</td> <td>Linear scale counting down</td> <td>Linear scale counting up</td> </tr> </tbody> </table> <p>Note: Forward movement is the linear scale counting up direction. For details, refer to 4.2.2 <i>Servomotor Movement Direction</i>.</p> <p>Press the  or  Key until the servomotor stops. If the origin search completed normally, "-Complete-" is displayed on the right top on the screen.</p>	Parameter		 Key	 Key	Pn000	n.□□□0	Linear scale counting up	Linear scale counting down	n.□□□1	Linear scale counting down	Linear scale counting up
Parameter		 Key	 Key											
Pn000	n.□□□0	Linear scale counting up	Linear scale counting down											
	n.□□□1	Linear scale counting down	Linear scale counting up											
5	<pre> BB      -Z-Search- Un000= 00000 Un002= 00000 Un003= 0000000000 Un00D= 0000001D58           </pre>		<p>When the origin search is completed, press the  Key.</p> <p>The status display changes from "RUN" to "BB", and the servomotor turns OFF. The display "-Complete-" changes to "-Z-Search-".</p>											
6	<pre> BB      -FUNCTION- Fn002:JOG Fn003:Z-Search Fn004:Program JOG Fn005:Prm Init           </pre>		<p>Press the  Key.</p> <p>The display returns to the main menu of the utility function.</p>											
7	To enable the setting, turn the power supply to the SERVOPACK OFF and ON again.													

## 6.5 Program JOG Operation (Fn004)

The program JOG operation is a utility function, that allows continuous operation determined by the preset operation pattern, movement distance, movement speed, acceleration/deceleration time, waiting time, and number of times of movement.

This function can be used to move the servomotor without it having to be connected to a host controller for the machine as a trial operation in JOG operation mode. Program JOG operation can be used to confirm the operation and for simple positioning operations.

### (1) Preparation

The following conditions must be met to perform the program JOG operation.

- The write prohibited setting (Fn010) must be set to Write permitted (P.0000).
- The main circuit power supply must be ON.
- All alarms must be cleared.
- The hardwire baseblock (HWBB) must be disabled.
- The servomotor power must be OFF.
- The travel distance and speed must be set correctly considering the machine operation range and safe operation speed.
- There must be no overtravel.

### (2) Additional Information

- The functions that are applicable for position control, such as position reference filter, can be used.
- The overtravel function is enabled in this function.

### (3) Program JOG Operation Patterns

A program JOG operation pattern is shown here. This program JOG operation pattern shows when the moving direction of the servomotor is set as Pn000.0 = 0 (Sets the linear scale counting up direction as the forward direction.).

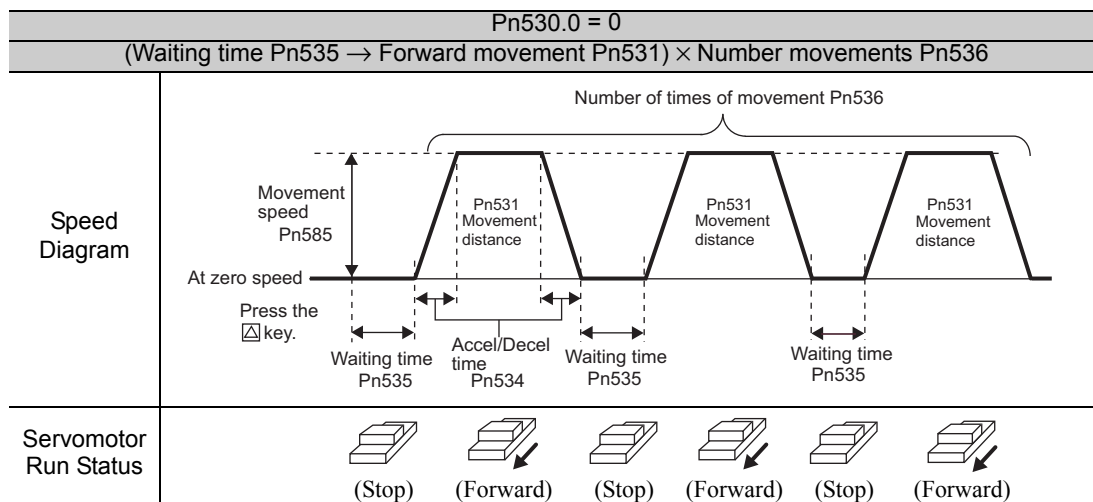

Note: When Pn536 (number of times of program JOG movement) is set to 0, infinite time operation is enabled. To stop infinite time operation, press the JOG/SVON Key to turn OFF the servomotor power.

**Pn530.0 = 1**  
 (Waiting time Pn535 → Reverse movement Pn531) × Number of movements Pn536

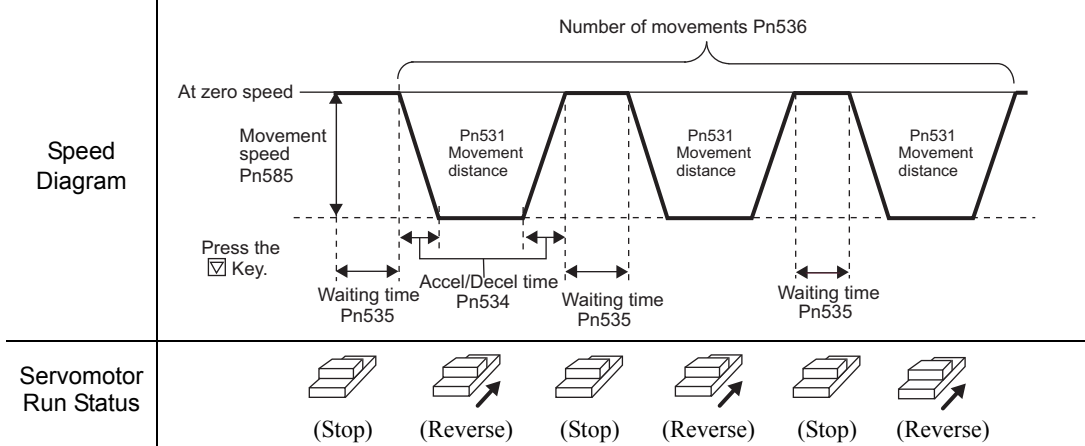

Note: When Pn536 (Number of Times of Program JOG Movement) is set to 0, infinite time operation is enabled. To stop infinite time operation, press the JOG/SVON Key to turn the servomotor power OFF.

**Pn530.0 = 2**  
 (Waiting time Pn535 → Forward movement Pn531) × Number of movements Pn536  
 (Waiting time Pn535 → Reverse movement Pn531) × Number of movements Pn536

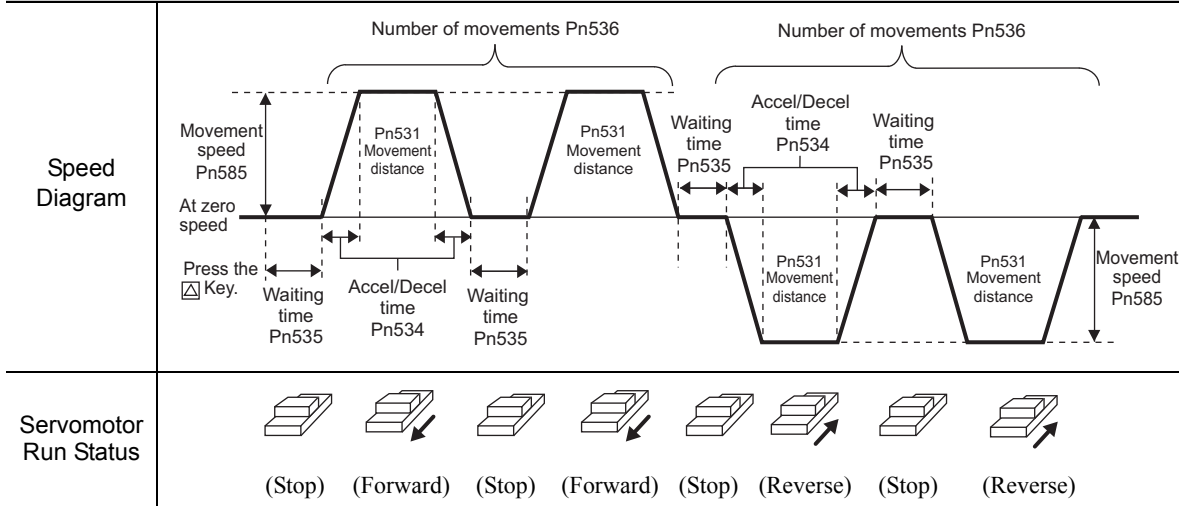

Note: When Pn530.0 is set to 2, infinite time operation is disabled.

**Pn530.0 = 3**  
 (Waiting time Pn535 → Reverse movement Pn531) × Number of movements Pn536  
 (Waiting time Pn535 → Forward movement Pn531) × Number of movements Pn536

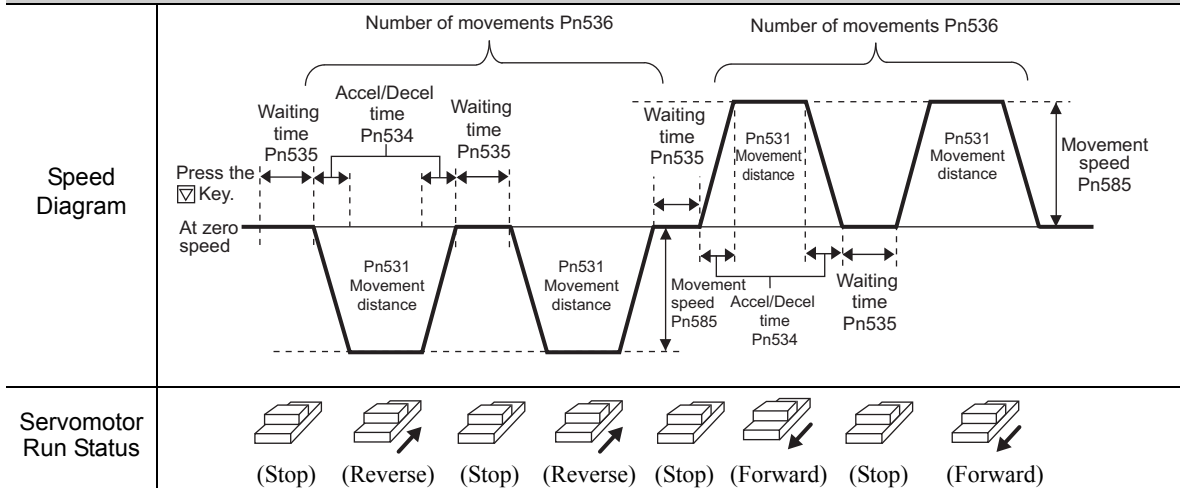

Note: When Pn530.0 is set to 3, infinite time operation is disabled.

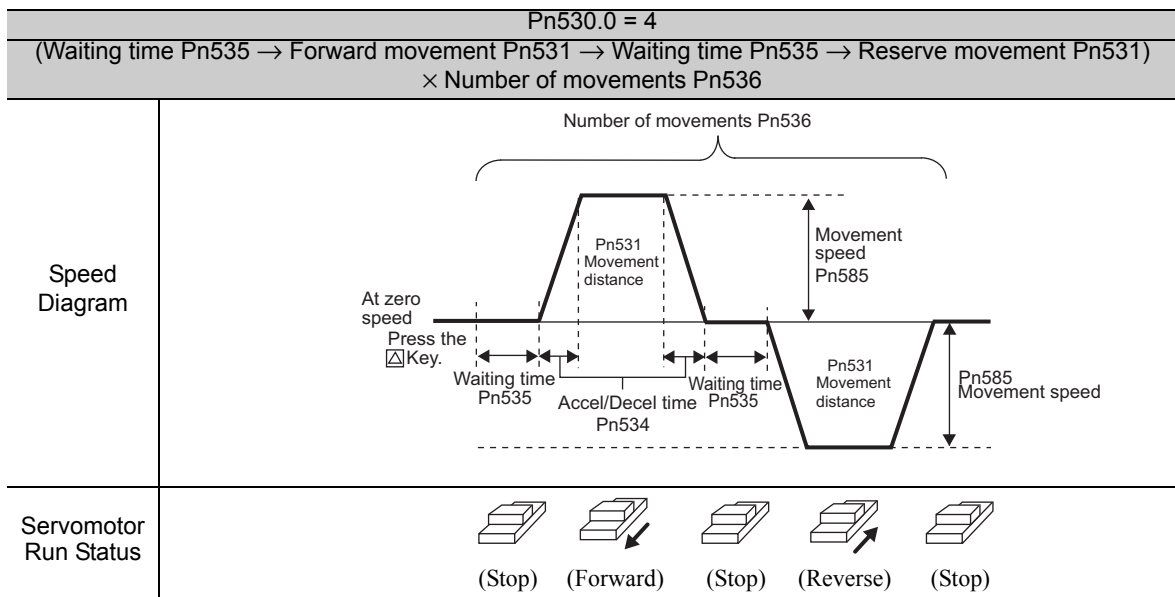

Note: When Pn536 (number of times of program JOG movement) is set to 0, infinite time operation is enabled. To stop infinite time operation, press the JOG/SVON Key to turn OFF the servomotor power.

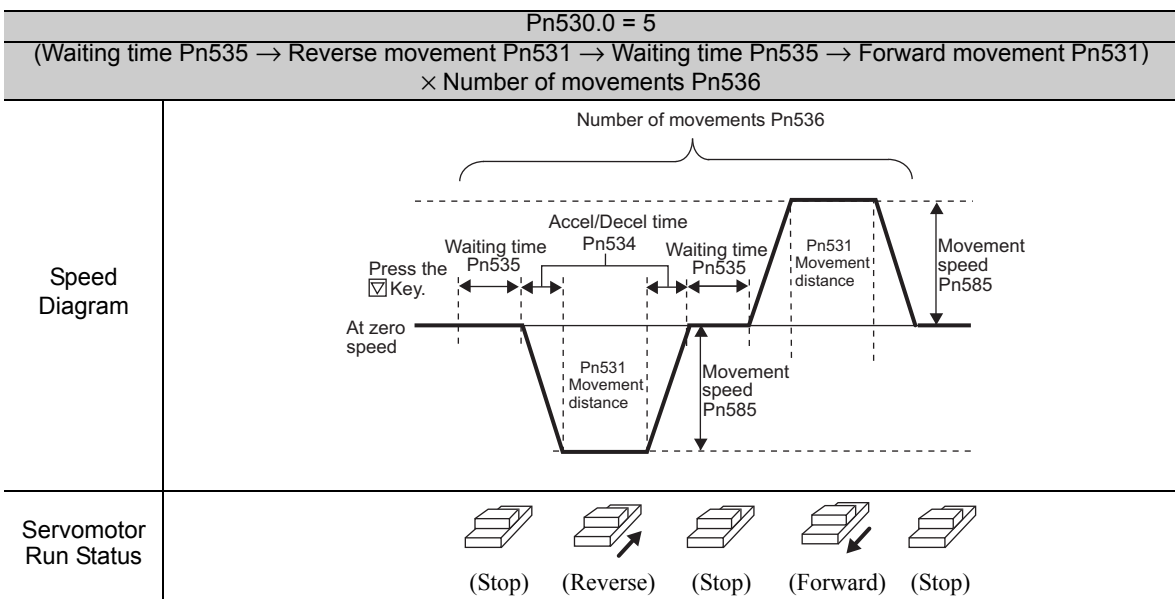

Note: When Pn536 (number of times of program JOG movement) is set to 0, infinite time operation is enabled. To stop infinite time operation, press the JOG/SVON Key to turn the servomotor power OFF.

#### (4) Related Parameters

The following parameters set the program JOG operation pattern. Do not change the settings while the program JOG operation is being executed.





















<b>Pn530</b>	Program JOG Operation Related Switch				Speed	Position	Force	Classification
	Setting Range	Setting Unit	Factory Setting	When Enabled				
	0000 to 0005	—	0000	Immediately		Setup		
<b>Pn531</b>	Program JOG Movement Distance				Speed	Position	Force	Classification
	Setting Range	Setting Unit	Factory Setting	When Enabled				
	1 to 1073741824	1 reference unit	32768	Immediately		Setup		

(cont'd)

Pn585	Program JOG Movement Speed <span style="float:right">Speed Position Force</span>				Classification
	Setting Range	Setting Unit	Factory Setting	When Enabled	
	1 to 10000	1 mm/s	50	Immediately	Setup
Pn534	Program JOG Acceleration/Deceleration Time <span style="float:right">Speed Position Force</span>				Classification
	Setting Range	Setting Unit	Factory Setting	When Enabled	
	2 to 10000	1 ms	100	Immediately	Setup
Pn535	Program JOG Waiting Time <span style="float:right">Speed Position Force</span>				Classification
	Setting Range	Setting Unit	Factory Setting	When Enabled	
	0 to 10000	1 ms	100	Immediately	Setup
Pn536	Number of Times of Program JOG Movement <span style="float:right">Speed Position Force</span>				Classification
	Setting Range	Setting Unit	Factory Setting	When Enabled	
	0 to 1000	1 time	1	Immediately	Setup

## (5) Operating Procedure

Use the following procedure to perform the program JOG operation after setting a program JOG operation pattern.

Step	Display after Operation	Keys	Operation
1	<pre> BB      - FUNCTION - Fn003:Z-Search Fn004:Program JOG Fn005:Prm Init Fn006:AlmHist Clr </pre>	  	<p>Press the  Key to view the main menu for the utility function.</p> <p>Use the  or  Key to move through the list and select Fn004.</p>
2	<pre> BB      - PRG JOG - Pn531=00032768 Pn534=00100 Pn536=00010 Pn585=00050 </pre>		<p>Press the  Key. The display changes to the Fn004 execution display.</p>
3*	<pre> BB      - PRG JOG - Pn531=00032768 Pn534=00100 Pn536=00010 Pn585=00050 </pre>	 	<p>Confirm that the parameters have been set.</p> <p>Press the  Key to view Pn530.</p> <p>Press the  Key to view the parameters in the following order: Pn530 → Pn531 → Pn534 → Pn535 → Pn536 → Pn585.</p>
4	<pre> RUN     - PRG JOG - Pn531=00032768 Pn534=00100 Pn536=00010 Pn585=00050 </pre>		<p>Press the  Key.</p> <p>The status display changes from "BB" to "RUN", and the servomotor power turns ON.</p>
5	<pre> RUN     - PRG JOG - Pn531=00032768 Pn534=00100 Pn536=00010 Pn585=00050 </pre>	 	<p>Press the  (forward movement start) or  (reverse movement start) Key according to the first movement direction of the preset operation pattern. The servomotor starts moving after the preset waiting time in Pn535.</p> <p>Note: Pressing the  Key again changes the status to "BB" (baseblocked status) and stops movement even during operation.</p>
6	<pre> RUN     - PRG JOG - Pn531=00032768 Pn534=00100 Pn536=00010 Pn585=00050 </pre>		<p>When the set program JOG operation movement is completed, "END" is displayed for one second, and then "RUN" is displayed.</p> <p>Press the  Key. The servomotor becomes baseblocked status. The display returns to the main menu of the utility function.</p>
7	To enable the setting, turn the power supply to the SERVOPACK OFF and ON again.		

\* The settings can be changed for a parameter.

## 6.6 Initializing Parameter Settings (Fn005)

This function is used when returning to the factory settings after changing parameter settings.

 <b>IMPORTANT</b>	<ul style="list-style-type: none"> <li>• Be sure to initialize the parameter settings while the servomotor power is OFF.</li> <li>• After initialization, turn OFF the power supply and then turn ON again to validate the settings.</li> <li>• Option module parameters are not initialized. For details on how to initialize the option module, refer to the manual for the connected option module.</li> </ul>
---	---

Note: Any value adjusted with Fn00C, Fn00D, Fn00E, and Fn00F cannot be initialized by Fn005.













### (1) Preparation

The following conditions must be met to initialize the parameter values.

- The write prohibited setting (Fn010) must be set to Write permitted (P.0000).
- The servomotor power must be OFF.

### (2) Operating Procedure

Use the following procedure.

Step	Display after Operation	Keys	Operation
1	<pre> BB      - FUNCTION - Fn004: Program JOG Fn005: Prm Init Fn006: AlmHist Clr Fn00C: MonZero Adj           </pre>	  	<p>Press the  Key to view the main menu for the utility function.</p> <p>Use the  or  Key to move through the list and select Fn005.</p>
2	<pre> BB Parameter Init Start : [DATA] Return: [SET]           </pre>		<p>Press the  Key. The display changes to the Fn005 execution display.</p>
3	<pre> BB Parameter Init Start : [DATA] Return: [SET]           </pre>	 	<p>Press the  Key to initialize parameters. During initialization, "Parameter Init" is flashing in the display.</p> <p>After the initialization is completed, "Parameter Init" stops flashing and the status display changes as follows: "BB" to "DONE" to "BB."</p> <p>Note: Press the  Key not to initialize parameters. The display returns to the main menu of the utility function.</p>
4	To enable the setting, turn the power supply to the SERVOPACK OFF and ON again.		

## 6.7 Clearing Alarm History (Fn006)

The clear alarm history function deletes all of the alarm history recorded in the SERVOPACK.

Note: The alarm history is not deleted when the alarm reset is executed or the main circuit power supply of the SERVOPACK is turned OFF.













### (1) Preparation

The follow conditions must be met to clear the alarm history.

- The write prohibited setting (Fn010) must be set to Write permitted (P.0000).

### (2) Operating Procedure

Use the following procedure.

Step	Display after Operation	Keys	Operation
1	<pre> BB      -FUNCTION- Fn005:Prm Init Fn006:AlmHist Clr Fn00C:MonZero Adj Fn00D:MonGain Adj           </pre>	  	<p>Press the  Key to view the main menu for the utility function.</p> <p>Use the  or  Key to move through the list and select Fn006.</p>
2	<pre> BB Alarm History   Data Clear   Start : [DATA]   Return: [SET]           </pre>		<p>Press the  Key to display the Fn006 (clearing alarm history) execution screen.</p>
3	<pre> BB Alarm History   Data Clear   Start : [DATA]   Return: [SET]           </pre>	 	<p>Press the  Key to clear the alarm history.</p> <p>While clearing the data, "DONE" is displayed in the status display. After the data has been successfully cleared, "BB" is displayed.</p> <p>Note: Press the  Key not to clear the alarm history. The display returns to the main menu of the utility function.</p>

## 6.8 Offset Adjustment of Analog Monitor Output (Fn00C)

This function is used to manually adjust the offsets for the analog monitor outputs (force reference monitor output and motor speed monitor output). The offset values are factory-set before shipping. Therefore, the user need not usually use this function.

### (1) Adjustment Example

An example of offset adjustment to the motor speed monitor is shown below.

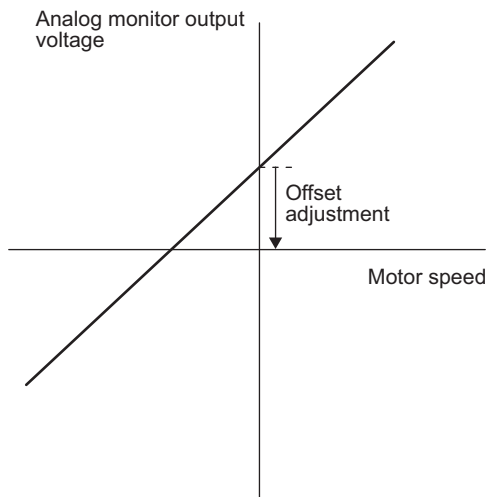

Item	Specifications
Offset Adjustment Range	-2.4 to + 2.4 V
Adjustment Unit	18.9 mV/LSB

Note:

- The adjustment value will not be initialized when parameter settings are initialized using Fn005.
- Make offset adjustment with a measuring instrument connected, so that the analog monitor output is zero. An example of settings for a zero analog monitor output is shown below.
  - While the servomotor is not turned ON, set the monitor signal to the force reference.
  - In speed control, set the monitor signal to the position error.























### (2) Preparation

The following condition must be met to adjust the offsets of the analog monitor output.

- The write prohibited setting (Fn010) must be set to Write permitted (P.0000).

## (3) Operating Procedure

Use the following procedure to perform the offset adjustment of analog monitor output.

Step	Display after Operation	Keys	Operation
1	<pre> BB          -FUNCTION- Fn006:AlmHist Clr Fn00C:MonZero Adj Fn00D:MonGain Adj Fn00E:Cur AutoAdj           </pre>	  	<p>Press the  Key to view the main menu for the utility function.</p> <p>Use the  or  Key to move through the list and select Fn00C.</p>
2	<pre> BB          -Zero ADJ- CH1=-0000<u>2</u> CH2= 00001 Un002= 00000 Un000= 00000           </pre>		<p>Press the  Key. The display changes to the Fn00C execution display.</p>
3	<pre> BB          -Zero ADJ- CH1=-0000<u>5</u> CH2= 00001 Un002= 00000 Un000= 00000           </pre>	 	<p>Press the  or  Key to adjust the offset of CH1 (force reference monitor).</p> <p>Adjust the offset so that the measurement instrument reading is as close to 0 V as possible.</p>
4	<pre> BB          -Zero ADJ- CH1=-00005 CH2= 0000<u>1</u> Un002= 00000 Un000= 00000           </pre>		<p>After the offset adjustment of CH1 has completed, adjust the offset of CH2 (motor moving speed monitor).</p> <p>Press the  Key. The cursor moves to CH2 side.</p>
5	<pre> BB          -Zero ADJ- CH1=-00005 CH2= 0000<u>6</u> Un002= 00000 Un000= 00000           </pre>	 	<p>Adjust the offset of CH2 in the same way as for CH1.</p> <p>Press the  or  Key to adjust the offset of CH2.</p> <p>Adjust the offset so that the measurement instrument reading is as close to 0 V as possible.</p>
6	<pre> BB          -Zero ADJ- CH1=-00005 CH2= 0000<u>6</u> Un002= 00000 Un000= 00000           </pre>		<p>After having completed the offset adjustment both for CH1 and CH2, press the  Key.</p> <p>The adjustment results are saved in the SERVO-PACK, and the status display shows "DONE" for one second. The status display then returns to show "BB" again.</p>
7	<pre> BB          -FUNCTION- Fn006:AlmHist Clr Fn00C:MonZero Adj Fn00D:MonGain Adj Fn00E:Cur AutoAdj           </pre>		<p>Press the  Key.</p> <p>The display returns to the main menu of the utility function.</p>

## 6.9 Gain Adjustment of Analog Monitor Output (Fn00D)

This function is used to manually adjust the gains for the analog monitor outputs (force reference monitor output and motor moving speed monitor output). The gain values are factory-set before shipping. Therefore, the user need not usually use this function.

### (1) Adjustment Example

An example of gain adjustment to the motor moving speed monitor is shown below.

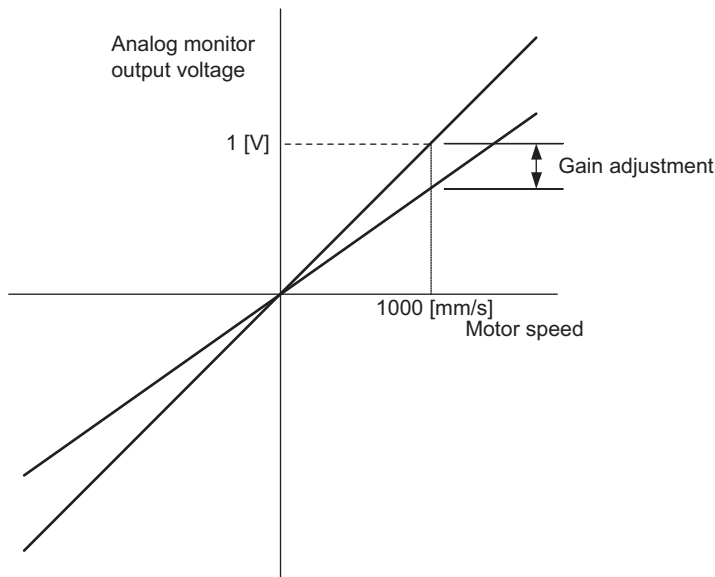

Item	Specifications
Gain-adjustment Range	100±50%
Adjustment Unit	0.4%/LSB

The gain adjustment range is made with a 100% output set as a center value (adjustment range: 50% to 150%). The following is a setting example.

#### <Setting the Set Value to -125>

$$100\% + (-125 \times 0.4) = 50\%$$

Therefore, the monitor output voltage is 0.5 time as high.

#### <Setting the Set Value to 125>

$$100\% + (125 \times 0.4) = 150\%$$

Therefore, the monitor output voltage is 1.5 times as high.

Note: The adjustment value will not be initialized when parameter settings are initialized using Fn005.























### (2) Preparation

The following condition must be met to adjust the gain of the analog monitor output.

- The write prohibited setting (Fn010) must be set to Write permitted (P.0000).

### (3) Operating Procedure

Use the following procedure to perform the gain adjustment of analog monitor output.

Step	Display after Operation	Keys	Operation
1	<pre> BB          -FUNCTION- Fn00C:MonZero Adj Fn00D:MonGain Adj Fn00E:Cur AutoAdj Fn00F:Cur ManuAdj           </pre>	  	<p>Press the  Key to view the main menu for the utility function.</p> <p>Use the  or  Key to move through the list and select Fn00D.</p>
2	<pre> BB          -Gain ADJ- CH1=-0000<u>1</u> CH2=-0000<u>1</u> Un002= 00000 Un000= 00000           </pre>		<p>Press the  Key. The display changes to the Fn00D execution display.</p>
3	<pre> BB          -Gain ADJ- CH1= 0012<u>5</u> CH2=-0000<u>1</u> Un002= 00000 Un000= 00000           </pre>	 	<p>Press the  or  Key to adjust the gain adjustment width of CH1 (force reference monitor).</p>
4	<pre> BB          -Gain ADJ- CH1= 0012<u>5</u> CH2=-0000<u>1</u> Un002= 00000 Un000= 00000           </pre>		<p>After the gain adjustment of CH1 has completed, adjust the gain adjustment width of CH2 (motor moving speed monitor).</p> <p>Press the  Key. The cursor moves to CH2 side.</p>
5	<pre> BB          -Gain ADJ- CH1= 0012<u>5</u> CH2=-0012<u>5</u> Un002= 00000 Un000= 00000           </pre>	 	<p>Adjust the gain of CH2 in the same way as for CH1.</p> <p>Press the  or  Key to adjust the gain adjustment width of CH2.</p>
6	<pre> BB          -Gain ADJ- CH1= 0012<u>5</u> CH2=-0012<u>5</u> Un002= 00000 Un000= 00000           </pre>		<p>After having completed the adjustment both for CH1 and CH2, press the  Key.</p> <p>The adjustment results are saved in the SERVO-PACK, and the status display shows "DONE" for one second. The status display then returns to show "BB" again.</p>
7	<pre> BB          -FUNCTION- Fn00C:MonZero Adj Fn00D:MonGain Adj Fn00E:Cur AutoAdj Fn00F:Cur ManuAdj           </pre>		<p>Press the  Key.</p> <p>The display returns to the main menu of the utility function.</p>

## 6.10 Automatic Offset-Signal Adjustment of the Motor Current Detection Signal (Fn00E)

Perform this adjustment only if highly accurate adjustment is required for reducing force ripple caused by current offset. The user need not usually use this function.

 <b>IMPORTANT</b>	<ul style="list-style-type: none"> <li>• Be sure to perform this function while the servomotor power is OFF.</li> <li>• Execute the automatic offset adjustment if the force ripple is too big when compared with those of other SERVOPACKs.</li> </ul>
---	---

Note: The adjusted value is not initialized by executing the Fn005 function (Initializing Parameter Settings).













### (1) Preparation

The following conditions must be met to automatically adjust the offset of the motor current detection signal.

- The write prohibited setting (Fn010) must be set to Write permitted (P.0000).
- The SERVOPACK must be in Servo Ready status (Refer to 4.6.4).
- The servomotor power must be OFF.

### (2) Operating Procedure

Use the following procedure.

Step	Display after Operation	Keys	Operation
1	<pre> BB          -FUNCTION- Fn00D: MonGain Adj Fn00E: Cur AutoAdj Fn00F: Cur ManuAdj Fn010: Prm Protect           </pre>	  	<p>Press the  Key to view the main menu for the utility function.</p> <p>Use the  or  Key to move through the list and select Fn00E.</p>
2	<pre> BB Auto Offset-ADJ of Motor Current Start : [DATA] Return: [SET]           </pre>		<p>Press the  Key. The display changes to the Fn00E execution display.</p>
3	<pre> BB Auto Offset-ADJ of Motor Current Start : [DATA] Return: [SET]           </pre>	 	<p>Press the  Key to start the automatic offset-signal adjustment of motor current detection.</p> <p>When the adjustment is completed, the status display shows "DONE" for one second. The status display then returns to show "BB" again.</p> <p>Note: Press the  Key to cancel the automatic adjustment. The display returns to the main menu of the utility function.</p>

## 6.11 Manual Offset-Signal Adjustment of the Motor Current Detection Signal (Fn00F)

Use this function only if the force ripple is still high after the automatic offset-signal adjustment of the motor current detection signal (Fn00E).



**IMPORTANT**

If this function is adjusted incorrectly and then executed, characteristics of the servomotor performance could be affected.

Observe the following precautions when performing manual servo tuning.

- Run the servomotor at a speed of approximately 100 mm/s.
- Adjust the offset while monitoring the force reference with the analog monitor until the ripple of force reference monitor's waveform is minimized.
- Adjust the phase-U and phase-V offset amounts alternately several times until these offsets are well balanced.

Note: The adjusted value is not initialized by executing the Fn005 function (Initializing Parameter Settings).



















### (1) Preparation

The following condition must be met to manually adjust the offset of the motor current detection signal.









- The write prohibited setting (Fn010) must be set to Write permitted (P.0000).

### (2) Operating Procedure

Use the following procedure.

Step	Display after Operation	Keys	Operation
1	<pre> BB      -FUNCTION- Fn00F:Cur ManuAdj Fn010:Prm Protect Fn011:Motor Info Fn012:Soft Ver           </pre>	  	<p>Press the  Key to view the main menu for the utility function.</p> <p>Use the  or  Key to move through the list and select Fn00F.</p>
2	<pre> BB Manual Offset-ADJ of Motor Current ZADJIU=-00009 ZADJIV=-00006           </pre>		<p>Press the  Key.</p> <p>The display changes to the Fn00F execution display.</p>
3	<pre> RUN Manual Offset-ADJ of Motor Current ZADJIU=-00009 ZADJIV=-00006           </pre>	-	<p>Input the servo ON command from the host controller.</p>
4	<pre> RUN Manual Offset-ADJ of Motor Current ZADJIU=-00019 ZADJIV=-00006           </pre>	 	<p>First, adjust the phase-U offset.</p> <p>Press the  or  Key to change the offset.</p> <p>Change the set value in increments of 10 in the direction where the force ripple decreases, and when you find the value where the force ripple is minimized, set that value.</p> <p>Adjustment range: -512 to +511</p>
5	<pre> RUN Manual Offset-ADJ of Motor Current ZADJIU=-00019 ZADJIV=-00006           </pre>		<p>Press the  key to move the cursor to the V-phase offset (ZADJIV).</p>
6	<pre> RUN Manual Offset-ADJ of Motor Current ZADJIU=-00019 ZADJIV=-00016           </pre>	 	<p>Next, adjust the phase-V offset.</p> <p>Press the  or  Key to change the offset.</p> <p>In the same way you adjusted the phase-U offset, change the set value in increments of 10 in the direction where the force ripple decreases, and when you find the value where the force ripple is minimized, set that value.</p> <p>Adjustment range: -512 to +511</p>

(cont'd)

Step	Display after Operation	Keys	Operation
7	<pre> RUN Manual Offset-ADJ of Motor Current ZADJIU=-00019 ZADJIV=-00016 </pre>		Press the  key to move the cursor to the U-phase offset (ZADJIU).
8	<pre> RUN Manual Offset-ADJ of Motor Current ZADJIU=-00024 ZADJIV=-00021 </pre>	  	Repeat steps 4 through 7 a number of times using a smaller amount of change than was previously used* to make fine adjustments to the offsets.
9	<pre> RUN Manual Offset-ADJ of Motor Current ZADJIU=-00019 ZADJIV=-00016 </pre>		Press the  Key to save the result of adjustment in the SERVOPACK. When the saving is completed, the status display shows "DONE" for one second. The status display then returns to show "RUN" again.
10	<pre> RUN          -FUNCTION- Fn00F:Cur ManuAdj Fn010:Prm Protect Fn011:Motor Info Fn012:Soft Ver </pre>		Press the  Key. The display returns to the main menu of the utility function.

\* Examples of the amount to adjust the offsets

- First time: Increments of 10
- Second time: Increments of 5
- Third time: Increments of 1

The above values are a rough guide. Adjust the amount to adjust the offset and the number of times to repeat the changes according to your system.

## 6.12 Write Prohibited Setting (Fn010)

This function prevents changing parameters by mistake and sets restrictions on the execution of the utility function.

Parameter changes and execution of the utility function become restricted in the following manner when Write prohibited (P.0001) is assigned to the write prohibited setting (Fn010).

- Parameters: Cannot be changed. If you attempt to change it, "NO-OP" will flash on the display and the screen will return to the main menu.
- Utility Function: Some functions cannot be executed. (Refer to the following table.) If you attempt to execute these utility functions, "NO-OP" will flash on the display and the screen will return to the main menu.

Parameter No.	Function	Write Prohibited Setting	Reference Section
Fn000	Alarm history display	Executable	6.2
Fn002	JOG operation	Cannot be executed	6.3
Fn003	Origin search	Cannot be executed	6.4
Fn004	Program JOG operation	Cannot be executed	6.5
Fn005	Initializing parameter settings	Cannot be executed	6.6
Fn006	Clearing alarm history	Cannot be executed	6.7
Fn00C	Offset adjustment of analog monitor output	Cannot be executed	6.8
Fn00D	Gain adjustment of analog monitor output	Cannot be executed	6.9
Fn00E	Automatic offset-signal adjustment of the motor current detection signal	Cannot be executed	6.10
Fn00F	Manual offset-signal adjustment of the motor current detection signal	Cannot be executed	6.11
Fn010	Write prohibited setting	–	6.12
Fn011	Servomotor model display	Executable	6.13
Fn012	Software version display	Executable	6.14
Fn014	Resetting configuration error in option modules	Cannot be executed	6.15
Fn01B	Vibration detection level initialization	Cannot be executed	6.16
Fn01E	Display of SERVOPACK and servomotor ID	Executable	6.17
Fn020	Origin setting	Cannot be executed	6.18
Fn030	Software reset	Executable	6.19
Fn080	Polarity Detection	Cannot be executed	6.20
Fn200	Tuning-less levels setting	Cannot be executed	5.2.2
Fn201	Advanced autotuning	Cannot be executed	5.3.2
Fn202	Advanced autotuning by reference	Cannot be executed	5.4.2
Fn203	One-parameter tuning	Cannot be executed	5.5.2
Fn204	Anti-resonance control adjustment function	Cannot be executed	5.6.2
Fn205	Vibration suppression function	Cannot be executed	5.7.2
Fn206	EasyFFT	Cannot be executed	6.21
Fn207	Online vibration monitor	Cannot be executed	6.22

## (1) Preparation















There are no tasks that must be performed before the execution.

## (2) Operating Procedure

Follow the steps to set enable or disable writing.

Setting values are as follows:

- "P.0000": Write permitted (Releases write prohibited mode.) [Factory setting]
- "P.0001": Write prohibited (Parameters become write prohibited from the next power ON.)

Step	Display after Operation	Keys	Operation
1	<pre> BB      -FUNCTION- Fn00F:Cur ManuAdj Fn010:Prm Protect Fn011:Motor Info Fn012:Soft Ver           </pre>	  	<p>Press the  Key to view the main menu for the utility function.</p> <p>Use the  or  Key to move through the list and select Fn010.</p>
2	<pre> BB Parameter Write Protect  P. 0000           </pre>		<p>Press the  Key. The display changes to the Fn010 execution display.</p>
3	<pre> BB Parameter Write Protect  P. 0001           </pre>	 	<p>Press the  or  Key to select one of the following settings.</p> <p>P.0000: Write permitted [Factory setting] P.0001: Write prohibited</p>
4	<pre> BB Parameter Write Protect  P. 0001           </pre>		<p>Press the  Key. The setting value is written into the SERVOPACK, and the status display changes as follows: "BB" to "DONE" to "BB."</p>
5	To enable the setting, turn the power supply to the SERVOPACK OFF and ON again.		

Note: To make the setting available, change the setting to P.0000 as shown in step 3.

## 6.13 Servomotor Model Display (Fn011)











This function is used to check the servomotor model, voltage, capacity, encoder type, and the number of divisions of linear scale's pitch. If the SERVOPACK has been custom-made, you can also check the specification codes of SERVOPACKs.

### (1) Preparation

There are no tasks that must be performed before the execution.

### (2) Operating Procedure

Use the following procedure.

Step	Display after Operation	Keys	Operation																
1	<pre> BB      - FUNCTION - Fn010: Prm Protect Fn011: Motor Info Fn012: Soft Ver Fn014: Opt Init           </pre>	  	<p>Press the  Key to view the main menu for the utility function.</p> <p>Use the  or  Key to move through the list and select Fn011.</p>																
2	<div style="display: flex; justify-content: space-between;"> <div style="border: 1px solid black; padding: 2px;">             Servomotor model 40 Linear servomotor           </div> <div style="border: 1px solid black; padding: 2px;">             Servomotor capacity 400 W           </div> </div> <p>Servomotor input voltage</p> <pre> BB      - MotorInfo - TYPE 40 AC200V ENCODER 01 8 bit           </pre> <table border="1" style="width: 100%; border-collapse: collapse;"> <thead> <tr> <th colspan="2">Encoder type</th> <th colspan="2">No. of Divisions</th> </tr> <tr> <th>Code</th> <th>Type</th> <th>Data</th> <th>Resolution</th> </tr> </thead> <tbody> <tr> <td>00</td> <td>Incremental</td> <td>8</td> <td>256</td> </tr> <tr> <td>01</td> <td>Absolute</td> <td>12</td> <td>4096</td> </tr> </tbody> </table>	Encoder type		No. of Divisions		Code	Type	Data	Resolution	00	Incremental	8	256	01	Absolute	12	4096		<p>Press the  Key. The display changes to the Fn011 execution display and shows the information about the servomotor and linear scale being used.</p>
Encoder type		No. of Divisions																	
Code	Type	Data	Resolution																
00	Incremental	8	256																
01	Absolute	12	4096																
3	<pre> BB      - FUNCTION - Fn010: Prm Protect Fn011: Motor Info Fn012: Soft Ver Fn014: Opt Init           </pre>		<p>Press the  Key. The display returns to the main menu of the utility function.</p>																

## 6.14 Software Version Display (Fn012)



















This function displays the software versions of the SERVOPACK, encoder, and option module.

### (1) Preparation

There are no tasks that must be performed before the execution.

### (2) Operating Procedure

Use the following procedure.

Step	Display after Operation	Keys	Operation
1	<pre> BB      -FUNCTION- Fn011:Motor Info Fn012:Soft Ver Fn014:Opt Init Fn01B:Viblv Init           </pre>	  	<p>Press the  Key to view the main menu for the utility function.</p> <p>Use the  or  Key to move through the list and select Fn012.</p>
2	<pre> BB      -Soft Ver- DRIVER Ver.=0001 ENCODER Ver.=0003           </pre>		<p>Press the  Key. The display changes to the Fn012 execution display. The software versions of the SERVOPACK, the connected encoder, and the option module will be displayed.</p> <p>Note: If the servomotor is not connected, "Not connect" is displayed.</p>
3	<pre> BB      -Soft Ver- OPTION ENCODER Ver.=0001           </pre>		<p>Press the  Key. The software version of the encoder is displayed.</p> <p>Note: If an encoder is not connected, "Not connect" will be displayed.</p>
4	<pre> BB      -Soft Ver- COMMAND Ver.=0001           </pre>		<p>Press the  Key. The software version of the command option module is displayed.</p> <p>Note: If a command option module is not connected, "Not connect" will be displayed.</p>
5	<pre> BB      -Soft Ver- SAFETY Ver.=0001           </pre>		<p>Press the  Key. The software version of the safety option module is displayed.</p> <p>Note: If a safety option module is not connected, "Not connect" will be displayed.</p>
6	<pre> BB      -Soft Ver- FEEDBACK Ver.=0001           </pre>		<p>Press the  Key. The software version of the feedback option module is displayed.</p> <p>Note: If a feedback option module is not connected, "Not connect" will be displayed.</p>
7	<pre> BB      -FUNCTION- Fn011:Motor Info Fn012:Soft Ver Fn013:MturnLmSet Fn014:Opt Init           </pre>		<p>Press the  Key. The display returns to the main menu of the utility function.</p>

## 6.15 Resetting Configuration Errors in Option Modules (Fn014)

The SERVOPACK with option module recognizes installation status and types of option modules that are connected to SERVOPACK. If an error is detected, the SERVOPACK issues an alarm. This function clears these alarms.

- Note 1. Alarms related to option module can be cleared only by this function. These alarms cannot be cleared by alarm reset or turning OFF the main circuit power supply.  
2. Before clearing the alarm, perform corrective action for the alarm.



















### (1) Preparation

The following condition must be met to clear detection alarms of the option module.

- The write prohibited setting (Fn010) must be set to Write permitted (P.0000).

### (2) Operating Procedure

Use the following procedure.

Step	Display after Operation	Keys	Operation
1	<pre> BB          -FUNCTION- Fn012:Soft Ver Fn014:Opt Init Fn01B:VibLvl Init Fn01E:SvMotOp ID           </pre>	  	Press the  Key to view the main menu for the utility function. Use the  or  Key to move through the list and select Fn014.
2	<pre> BB          -Opt Init- 01:Command Opt 02:Safety Opt 03:Feedback Opt           </pre>		Press the  Key. The display changes to the Fn014 execution display.
3	<pre> BB          -Opt Init- 01:Command Opt 02:Safety Opt 03:Feedback Opt           </pre>	 	Press the  or  Key to select an option module to be cleared.
4	<pre> BB          -Opt Init- Command Opt Initialize Start :[DATA] Return:[SET]           </pre>		Press the  Key. The display shown on the left appears.
5	<pre> BB          -Opt Init- 01:Command Opt 02:Safety Opt 03:Feedback Opt           </pre>		Press the  Key to clear the configuration error of the option module. The error is cleared and the status display shows "DONE" for one second. The status display then returns to step 3.
6	<pre> BB          -FUNCTION- Fn012:Soft Ver Fn014:Opt Init Fn01B:VibLvl Init Fn01E:SvMotOp ID           </pre>		Press the  Key. The display returns to the main menu of the utility function.
7	To enable the setting, turn the power supply to the SERVOPACK OFF and ON again.		

## 6.16 Vibration Detection Level Initialization (Fn01B)

This function detects vibration when servomotor is connected to a machine in operation and automatically adjusts the vibration detection level (Pn384) to output more exactly the vibration alarm (A.520) and the vibration warning (A.911).

The vibration detection function detects vibration elements according to the motor speed.

Parameter		Meaning	When Enabled	Classification
<b>Pn310</b>	n.□□□0 [Factory setting]	Does not detect vibration.	Immediately	Setup
	n.□□□1	Outputs the warning (A.911) when vibration is detected.		
	n.□□□2	Outputs the alarm (A.520) when vibration is detected.		

If the vibration exceeds the detection level calculated by the following formula, the alarm or warning will be output according to the setting of vibration detection switch (Pn310).

$$\text{Detection level} = \frac{\text{Vibration detection level (Pn384 [mm/s])} \times \text{Vibration detection sensitivity (Pn311 [\%])}{100}$$

- Use this function if the vibration alarm (A.520) or the vibration warning (A.911) is not output correctly when a vibration at the factory setting of the vibration detection level (Pn384) is detected. In other cases, it is not necessary to use this function.
- The vibration alarm or warning detection sensibility differs depending on the machine conditions. In this case, fine-tune the setting of the vibration detection sensitivity (Pn311) using the above detection level formula as a guide.

<b>Pn311</b>	Vibration Detection Sensitivity				Classification
	<input type="checkbox"/> Speed <input type="checkbox"/> Position <input type="checkbox"/> Force				
	Setting Range	Setting Unit	Factory Setting	When Enabled	
	50 to 500	1%	100	Immediately	Tuning



### IMPORTANT

- The vibration may not be detected because of improper servo gains. Also, not all kinds of vibrations can be detected. Use the detection result as a guideline.
- Set a proper mass ratio (Pn103). Improper setting may result in the vibration alarm, warning misdetection, or non-detection.
- The references that are used to operate your system must be input to execute this function.
- Execute this function under the operating condition for which the vibration detection level should be set.
- Execute this function while the motor speed reaches at least 10% of its maximum.















### (1) Preparation

The following conditions must be met to initialize the vibration detection level.

- The write prohibited setting (Fn010) must be set to Write permitted (P.0000).
- The test without a motor function must be disabled (Pn00C.0 = 0).

## (2) Operating Procedure

Use the following procedure.

Step	Display after Operation	Keys	Operation
1	<pre> RUN      - FUNCTION - Fn014:Opt Init Fn01B:Viblv Init Fn01E:SvMotOp ID Fn020:S-Orig Set                     </pre>	  	Press the  Key to view the main menu for the utility function. Use the  or  Key to move through the list and select Fn01B.
2	<pre> RUN Vibration Detect Level Init Start : [DATA] Return: [SET]                     </pre>		Press the  Key. The display changes to the Fn01B execution display.
3	<pre> RUN Vibration Detect Level Init  Init                     </pre>		Press the  Key. "Init" is displayed flashing, and the vibration level is detected and initialized. Note: Continues initialization until the  Key is pressed again.
4	<pre> RUN Vibration Detect Level Init  DONE                     </pre>		Press the  Key. The display changes from "Init" to "DONE," for one second and the new setting of Pn384 becomes enabled.
5	<pre> RUN      - FUNCTION - Fn014:Opt Init Fn01B:Viblv Init Fn01E:SvMotOp ID Fn020:S-Orig Set                     </pre>		Press the  Key. The display returns to the main menu of the utility function.

## (3) Related Parameters

The following table lists parameters related to this function and their possibility of being changed while executing this function or of being changed automatically after executing this function.

- Parameters related to this function  
 These are parameters that are used or referenced when executing this function.
- Allowed changes during execution of this function  
 Yes: Parameters can be changed using SigmaWin+ while this function is being executed.  
 No: Parameters cannot be changed using SigmaWin+ while this function is being executed.
- Automatic changes after execution of this function  
 Yes: Parameter set values are automatically set or adjusted after execution of this function.  
 No: Parameter set values are not automatically set or adjusted after execution of this function.

Parameter	Name	Mid-execution changes	Automatic changes
<b>Pn311</b>	Vibration Detection Sensitivity	Yes	No
<b>Pn384</b>	Vibration Detection Level	No	Yes

## 6.17 Display of SERVOPACK and Servomotor ID (Fn01E)

This function displays ID information for SERVOPACK, servomotor, linear scale, and option module connected to the SERVOPACK. The ID information of some option modules is not stored in the SERVOPACK. "Not available" will be displayed for these option modules.

The digital operator (model: JUSP-OP05A-1-E) or SigmaWin+ engineering tool is required to execute this function.

Refer to *Σ-V Series User's Manual, Operation of Digital Operator* (No.: SIEP S800000 55) for the operating procedure of the digital operator.

The following items can be displayed.

ID	Items to be Displayed
SERVOPACK ID	<ul style="list-style-type: none"> <li>• SERVOPACK model</li> <li>• SERVOPACK serial number</li> <li>• SERVOPACK manufacturing date</li> <li>• SERVOPACK input voltage (V)</li> <li>• Maximum applicable motor capacity (W)</li> <li>• Maximum applicable motor rated current (Arms)</li> </ul>
Servomotor ID	<ul style="list-style-type: none"> <li>• Servomotor model</li> <li>• Servomotor order number</li> <li>• Servomotor manufacturing date</li> <li>• Servomotor input voltage (V)</li> <li>• Servomotor capacity (W)</li> <li>• Servomotor rated current (Arms)</li> </ul>
Encoder ID	<ul style="list-style-type: none"> <li>• Linear scale model</li> <li>• Linear scale or serial converter unit serial number</li> <li>• Linear scale or serial converter unit manufacturing date</li> <li>• Linear scale type/resolution</li> </ul>
Command Option Module ID*	<ul style="list-style-type: none"> <li>• Command option module model</li> <li>• Command option module serial number</li> <li>• Command option module manufacturing date</li> <li>• Command option module ID number</li> </ul>
Safety Option Module ID*	<ul style="list-style-type: none"> <li>• Safety Option Module model</li> <li>• Safety Option Module serial number</li> <li>• Safety Option Module manufacturing date</li> <li>• Safety Option Module ID number</li> </ul>
Feedback Option Module ID*	<ul style="list-style-type: none"> <li>• Feedback Option Module model</li> <li>• Feedback Option Module serial number (Reserved area)</li> <li>• Feedback Option Module manufacturing date</li> <li>• Feedback Option Module ID</li> </ul>













































\* If the option module is not connected, "Not connect" will be displayed after the module name.

### (1) Preparation

There are no tasks that must be performed before the execution.

## (2) Operating Procedure

Use the following procedure.

Step	Display after Operation	Keys	Operation
1	<pre> RUN          -FUNCTION- Fn01B:ViblvI Init Fn01E:SvMotOp ID Fn020:S-Orig Set Fn030:Soft Reset                     </pre>	  	<p>Press the  Key to view the main menu for the utility function.</p> <p>Use the  or  Key to move through the list and select Fn01E.</p>
2	<pre> Serial number- SERVOPACK model- BB          -SvMotOp ID- Driver SGDV-R70A15A D00241234590001 07.04 200V, 50W Manufacturing date  SERVOPACK input voltage  Motor capacity                     </pre>	  	<p>Press the  Key.</p> <p>The display changes to the Fn01E execution display. The SERVOPACK ID information is displayed. Use the  or  Key to scroll left and right and to view other information.</p>
3	<pre> Motor order number- Servomotor model- BB          -SvMotOp ID- Motor SGLGW-30A050C 123456789000000 07.04 200V, 40W Motor manufacturing date  Motor input voltage  Motor capacity                     </pre>	  	<p>Press the  Key.</p> <p>The servomotor ID information is displayed. Use the  or  Key to scroll left and right and to view other information.</p>
4	<pre> Linear scale or serial converter unit serial number- Linear scale model- BB          -SvMotOp ID- Encoder JZDP-D003-000 000000-000-000000 07.04 8bit-INC Linear scale or serial converter unit manufacturing date  Linear scale resolution  Linear scale type                     </pre>	  	<p>Press the  Key.</p> <p>The linear scale ID information is displayed. Use the  or  Key to scroll left and right and to view other information.</p>
5	<pre> BB          -SvMotOp ID- Command Option SGDV-OCA□□□                     </pre>	  	<p>Press the  Key. The command option module information is displayed. Use the  or  Key to scroll left or right and display other information.</p> <p>Note: If a command option module is not connected, "Not connect" will be displayed.</p>
6	<pre> BB          -SvMotOp ID- Safety Option SGDV-OSA□□□                     </pre>	  	<p>Press the  Key. The safety option module information is displayed. Use the  or  Key to scroll left or right and display other information.</p> <p>Note: If a safety option module is not connected, "Not connect" will be displayed.</p>
7	<pre> BB          -SvMotOp ID- Feedback Option SGDV-OSA□□□                     </pre>	  	<p>Press the  Key. The feedback option module information is displayed. Use the  or  Key to scroll left or right and display other information.</p> <p>Note: If a feedback option module is not connected, "Not connect" will be displayed.</p>
8	<pre> RUN          -FUNCTION- Fn01B:ViblvI Init Fn01E:SvMotOp ID Fn01F:FBOP Mot ID Fn020:S-Orig Set                     </pre>		<p>Press the  Key.</p> <p>The display returns to the main menu of the utility function.</p>

## 6.18 Origin Setting (Fn020)

This function is used to set the current position of an absolute linear scale as the origin (zero point position).

This function can be used with the following products.

Mitutoyo Corporation  
ABS ST780A series  
Model: ABS ST78□A/ST78□AL



### IMPORTANT

- After execution of origin setting, the servo ready (/S-RDY) signal will turn OFF (open) because the system position data will have been changed. Always turn the power supply to the SERVOPACK OFF and ON again.
- After execution of origin setting, the servomotor phase data in the SERVOPACK will be discarded. Execute polarity detection (Fn080) again to save the servomotor phase data in the SERVOPACK.















### (1) Preparation

The following conditions must be met to set the origin.

- The write prohibited setting (Fn010) must be set to Write permitted (P.0000).
- The servomotor power must be OFF.

### (2) Operating Procedure

Use the following procedure.

Step	Display after Operation	Keys	Operation
1	<pre> BB      -FUNCTION- Fn020: S- Orig Set Fn030: Soft Reset Fn080: Pole Detect Fn200: TuneLvl Set           </pre>	  	<p>Press the  Key to view the main menu for the utility function.</p> <p>Use the  or  Key to move through the list and select Fn020.</p>
2	<pre> BB Scale Origin Set ORGSET1           </pre>		<p>Press the  Key. The display changes to the Fn020 execution display.</p>
3	<pre> BB Scale Origin Set ORGSET5           </pre>	 	<p>Press the  or  Key to "ORGSET5".</p>
4	<pre> BB Scale Origin Set           </pre>		<p>Press the  key to start setting the origin. The message, "Scale Origin Set," flashes while the origin is being set. After the origin has been successfully set, the displayed status changes as follows: "BB" to "DONE" to "BB".</p>
5	To enable the setting, turn the power supply to the SERVOPACK OFF and ON again.		

## 6.19 Software Reset (Fn030)

This function enables resetting the SERVOPACK internally from software. This function is used when resetting alarms and changing the settings of parameters that normally require restarting the SERVOPACK. Parameters settings can also be enabled without turning the SERVOPACK OFF and ON again.

 <b>IMPORTANT</b>	<ul style="list-style-type: none"> <li>• Start software reset operation after the servomotor power is OFF.</li> <li>• This function resets the SERVOPACK independently of host controller. The SERVOPACK carries out the same processing as when the power supply is turned ON and outputs the ALM signal. The status of other output signals may be forcibly changed.</li> </ul>
---	---

















### (1) Preparation

The following condition must be met to perform a software reset.

- The servomotor power must be OFF.

### (2) Operating Procedure

Use the following procedure.

Step	Display after Operation	Keys	Operation
1	<pre> BB      -FUNCTION- Fn020:S-Orig Set Fn030:Soft Reset Fn080:Pole Detect Fn200:TuneLvl Set           </pre>	  	Press the  Key to view the main menu for the utility function. Use the  or  Key to move through the list and select Fn030.
2	<pre> BB Software Reset RESET1           </pre>		Press the  Key. The display changes to the Fn030 execution display.
3	<pre> BB Software Reset RESET5           </pre>	 	Press the  or  Key to select "RESET5".
4	<pre> BB Software Reset           </pre>		Press the  Key to execute the software reset. After the software reset starts, "RESET5" will no longer be displayed.
5	<pre> File First Loading Please Wait...           </pre>	-	After the reset has been successfully completed, the screen which appears when the power is turned ON will be displayed. The screen will then show parameters or monitor displays.
6	<pre> BB      -FUNCTION- Fn020:S-Orig Set Fn030:Soft Reset Fn080:Pole Detect Fn200:TuneLvl Set           </pre>		Press the  Key. The display returns to the main menu of the utility function.

## 6.20 Polarity Detection (Fn080)

The polarity detection function is used to detect the polarity and save the servomotor phase data in the SERVOPACK.























### (1) Preparation

The following conditions must be met to detect the polarity.

- The write prohibited setting (Fn010) must be set to Write permitted (P.0000).
- The main circuit power supply must be ON.
- No alarms have occurred except A.C22.
- The hardwire baseblock (HWBB) must be disabled.
- The servomotor power must be OFF.

### (2) Operating Procedure

Use the following procedure.

Step	Display after operation	Keys	Operation
1	<pre> BB      -FUNCTION- Fn030:Soft Reset Fn080:Pole Detect Fn200:TuneLvl Set Fn201:AAT           </pre>	  	<p>Press the  Key to view the main menu of the utility function.</p> <p>Use the  or  Key to move through the list and select Fn080.</p>
2	<pre> BB Magnetic Pole Detect Level=40           </pre>	    	<p>Press the  Key.</p> <p>The display changes to the Fn080 execution display.</p> <p>To adjust the level:</p> <p>Press the  or  Key to move the cursor from/to the digit.</p> <p>Press the  or  Key to change the value of each digit.</p>
3	<pre> BB Magnetic Pole Detect Start:[JOGSVON] Return:[SET]           </pre>		<p>Press the  Key. The display shown on the left will appear.</p>
4	<pre> P DET Magnetic Pole Adjustment Return:[SET]           </pre>		<p>Press the  Key. The servomotor will be in servo ON status and the polarity detection will start. During the polarity detection, "Magnetic Pole Adjustment" is displayed flashing. When the polarity detection is complete, the servomotor will be in servo OFF status.</p>
5	<pre> BB Magnetic Pole Detect Return:[SET]           </pre>	<p style="text-align: center;">-</p>	<p>When the polarity detection is complete, the display shown on the left will appear.</p>
6	<pre> BB      -FUNCTION- Fn030:Soft Reset Fn080:Pole Detect Fn200:TuneLvl Set Fn201:AAT           </pre>		<p>Press the  Key. The display returns to the main menu of the utility function.</p>

## 6.21 EasyFFT (Fn206)

EasyFFT sends a frequency waveform reference from the SERVOPACK to the servomotor and slightly moves the servomotor several times over a certain period, thus causing machine vibration. The SERVOPACK detects the resonance frequency from the generated vibration and makes notch filter settings according to the resonance frequency detection. The notch filter is effective for the elimination of high-frequency vibration and noise.

Execute this function after the servomotor power is turned OFF if there is high-frequency vibration or noise during operation.

### ⚠ WARNING

- The servomotor moves slightly when EasyFFT is executed. Do not touch the servomotor or machine during execution of EasyFFT, otherwise injury may result.

### ⚠ CAUTION

- Use the EasyFFT when the servo gain is low, such as in the initial stage of servo adjustment. If EasyFFT is executed after increasing the gain, the servo system may vibrate depending on the machine characteristics or gain balance.

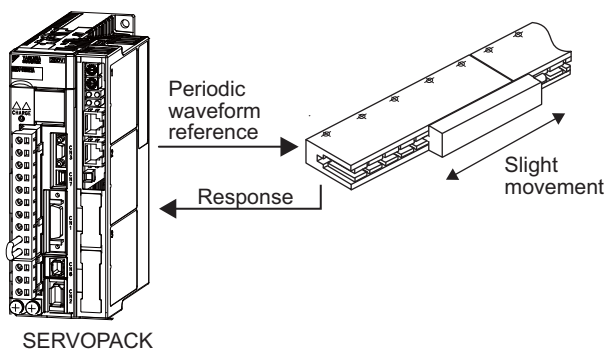

In addition to this function, online vibration monitor (Fn207) can be used to detect machine vibration and automatically make notch filter settings.

If a  $\Sigma$ -V Series SERVOPACK is used to make adjustments, it is recommended to use advanced autotuning. This built-in EasyFFT function is used to maintain interchangeability with previous models. There is normally no need to use it.





















### (1) Preparation

The following conditions must be met to perform EasyFFT.









- The write prohibited setting (Fn010) must be set to Write permitted (P.0000).
- The main circuit power supply must be ON.
- All alarms must be cleared.
- The hardwire baseblock (HWBB) must be disabled.
- The servomotor power must be OFF.
- There must be no overtravel.
- The test without a motor function must be disabled (Pn00C.0 = 0).
- An external reference must not be input.

## (2) Operating Procedure

Use the following procedure.

Step	Display after Operation	Keys	Operation
1	<pre> BB          -FUNCTION- Fn205:Vib Sup Fn206:Easy FFT Fn207:V-Monitor Fn000:Alm History           </pre>	  	<p>Press the  Key to view the main menu for the utility function.</p> <p>Use the  or  Key to move through the list and select Fn206.</p>
2	<pre> BB          -Easy FFT- Setting Input = 015%           </pre>		<p>Press the  Key. The display changes to the Fn206 execution display.</p>
3	<pre> BB          -Easy FFT- Setting Input = 015%           </pre>	 	<p>The cursor is on the setting of "Input." Press the  or  Key to set the sweep force reference amplitude (Pn456) Setting range: 1 to 800. Note: When making the initial settings for EasyFFT, do not change the setting for the reference amplitude. Start with the original value of 15. Increasing reference amplitude increases the detection accuracy, but the vibration and noise from the machine will increase. Increase the amplitude value little by little.</p>
4	<pre> RUN         -Easy FFT- Ready Input = 015%           </pre>		<p>Press the  Key to turn the servomotor power ON. The display "BB" and "Setting" changes to "RUN" and "Ready."</p>
5	<pre> RUN         -Easy FFT- Measure Input = 015%           </pre>	 	<p>Press the  (forward run start) Key or  (reverse run start) Key to run the servomotor and start the frequency measurement. "Measure" is displayed during the measurement. Within 10 mm, the servomotor will move forward and then in reverse several times. Notes:</p> <ul style="list-style-type: none"> <li>• Press the  Key to cancel the measurement. The servomotor stops moving and the power turns OFF. The detection of the resonance frequency is not completed.</li> <li>• The actions of the servomotor are very minute in this operation. Also at the same time, the servomotor emits a noise. To ensure safety, do not enter the working envelope of the motor.</li> </ul>
6	<pre> BB          -Easy FFT- Result Input = 015% Res = 1250 Hz Filter1 1250 Hz           </pre>		<p>When the detection processing is successfully completed, "Measure" stops flashing and the results and the notch filter value to be set are displayed. If the processing was not completed, "No Measure" is displayed. To check the results, go to step 8. &lt; Important &gt; If two seconds or more are required for the operation although detection was successfully completed, the detection accuracy might be insufficient. Increasing reference amplitude more than 15 increases the detection accuracy, but the vibration and noise from the machine will increase. Increase the amplitude value little by little. Notes:</p> <ul style="list-style-type: none"> <li>• If a notch filter has been set and is being used, "*" is displayed on the second line.</li> <li>• If the first stage notch filter has been set, the second stage notch filter value is displayed. If the first and second stage notch filters have been set, only the result of frequency detection is displayed.</li> </ul>

(cont'd)

Step	Display after Operation	Keys	Operation
7	<pre> BB          -Easy FFT- Ready Input = 015% </pre>	 	<p>To exit the EasyFFT function at this stage, press the  Key. The power to the servomotor is turned OFF and the display returns to the main menu of the utility function.</p> <p>To remeasure the resonance frequency, press the  Key to return to step 4 and then execute steps 5 to 7.</p>
8	<pre> DONE        -Easy FFT- Result Input = 015% Res = 1250 Hz Filter1 1250 Hz </pre>		<p>Press the  Key after the normal completion of frequency detection. The notch filter frequencies are automatically updated to the optimum values.</p> <p>The status display shows "DONE" and the display shown on the left appears.</p> <p>If the first stage notch filter frequency has been set (Pn408.0 = 1), the second stage notch filter frequency (Pn 40C) will automatically be updated.</p> <p>Notes:</p> <ul style="list-style-type: none"> <li>• If the first stage or the second stage notch filter frequency has already been set (Pn408 = n.□1□1), the notch filter frequency cannot be set.</li> <li>• If the frequency detected by this function is not used, set the notch filter to be invalid (Pn408.0 = 0).</li> </ul>
9	<pre> BB          -FUNCTION- Fn205:Vib Sup Fn206:Easy FFT Fn207:V-Monitor Fn000:Alm History </pre>		<p>Press the  Key.</p> <p>The servomotor enters a baseblocked status. The display returns to the main menu of the utility function.</p>
10	To enable the setting, turn the power supply to the SERVOPACK OFF and ON again.		

### (3) Related Parameters

The following table lists parameters related to this function and their possibility of being changed while executing this function or of being changed automatically after executing this function.

- Parameters related to this function

These are parameters that are used or referenced when executing this function.

- Allowed changes during execution of this function

Yes : Parameters can be changed using SigmaWin+ while this function is being executed.

No : Parameters cannot be changed using SigmaWin+ while this function is being executed.

- Automatic changes after execution of this function

Yes : Parameter set values are automatically set or adjusted after execution of this function.

No : Parameter set values are not automatically set or adjusted after execution of this function.

Parameter	Name	Mid-execution changes	Automatic changes
<b>Pn408</b>	Force Related Function Switch	Yes	Yes
<b>Pn409</b>	1st Notch Filter Frequency	No	Yes
<b>Pn40A</b>	1st Notch Filter Q Value	No	No
<b>Pn40C</b>	2nd Notch Filter Frequency	No	Yes
<b>Pn40D</b>	2nd Notch Filter Q Value	No	No
<b>Pn456</b>	Sweep Force Reference Amplitude	No	No

## 6.22 Online Vibration Monitor (Fn207)

If vibration is generated during operation and this function is executed while the servomotor power is still ON, the machine vibration can sometimes be suppressed by setting a notch filter or force reference filter for the vibration frequencies.

When online, vibration frequency caused by machine resonance will be detected and the frequency that has the highest peak will be displayed on the panel operator. The effective force reference filter or notch filter frequency for the vibration frequencies will be automatically selected and the related parameters will be automatically set.

In addition to this function, EasyFFT (Fn206) can be used to detect machine vibration and automatically make notch filter settings. Use the following flowchart to determine how these functions should be used.

If a  $\Sigma$ -V Series SERVOPACK is used to make adjustments, it is recommended that you use advanced autotuning. This built-in function is used to maintain interchangeability with previous models. There is normally no need to use it.

How to use EasyFFT (Fn206) and online vibration monitor (Fn207), when they are mainly used for servo gain adjustment.

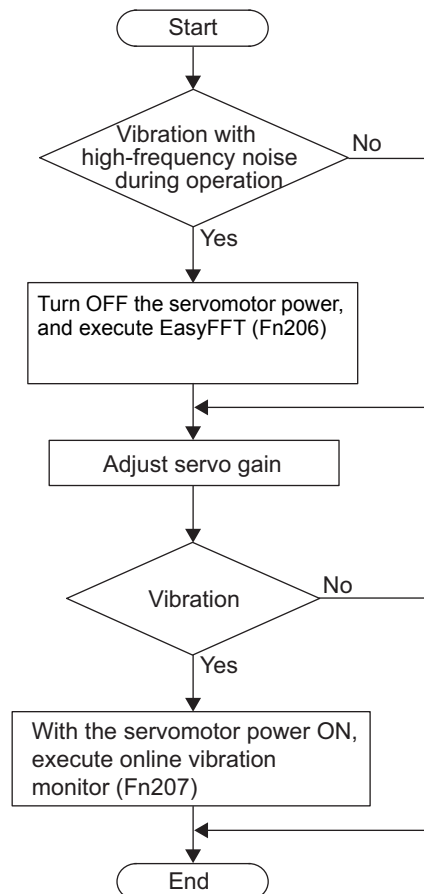



















### (1) Preparation

The following conditions must be met to perform online vibration monitoring.

- The write prohibited setting (Fn010) must be set to Write permitted (P.0000).
- The servomotor power must be ON.
- There must be no overtravel.
- The correct mass (Pn103) must be set.
- The test without a motor function must be disabled (Pn00C.0 = 0).

## (2) Operating Procedure

Use the following procedure.

Step	Display after Operation	Keys	Operation
1	<pre> RUN      -FUNCTION- Fn206:Easy FFT Fn207:V-Monitor Fn000:Alm History Fn001:JOG           </pre>	  	<p>Press the  Key to view the main menu for the utility function.</p> <p>Use the  or  Key to move through the list and select Fn207.</p>
2	<pre> RUN      -V-MONITOR- Measure F1=---- F2=---- F3=----           </pre>		<p>Press the  Key.</p> <p>The display changes to the Fn207 execution display.</p>
3	<pre> RUN      -V-MONITOR- Measure F1=---- F2=---- F3=----           </pre>		<p>Press the  Key for at least one second to start vibration detection. The  Key must be pressed until "Measure" flashes on the display.</p> <p>Note: After this message appears, the  Key does not have to be pressed and the detection continues automatically.</p>
4	<pre> RUN      -V-MONITOR- Measure F1= 0850[Hz] F2= 1600[Hz] F3= 0225[Hz]           </pre>		<p>When the vibration detection has completed, "Measure" stops flashing and the detection processing ends automatically. When the detection processing has completed normally, the vibrations with three largest peak values in vibration frequency are displayed for F1, F2, and F3.</p> <p>Notes:</p> <ul style="list-style-type: none"> <li>• Press the  Key to quit the online vibration monitor function. The display returns to the main menu of the utility function.</li> <li>• A detected frequency can be displayed. For a vibration with undetectable peak frequency, "----" is displayed. If no frequency was detected, "----" is displayed for F1, F2, and F3.</li> <li>• If the frequency could not be successfully detected, "NO MONITOR" is displayed.</li> </ul>
5	<pre> DONE     -V-MONITOR- SETTING DONE F1= 0850[Hz] F2= 1600[Hz] F3= 0225[Hz]           </pre>		<p>After the detection has normally completed, press the  Key. The optimum frequency (time constant) of notch filter or force reference filter for F1 is set automatically. At the same time, the parameter Pn409 is updated for a notch filter, or the parameter Pn401 is updated for a force reference filter.</p> <p>After the setting is successfully completed, "DONE" flashes.</p>
6	<pre> RUN      -FUNCTION- Fn206:Easy FFT Fn207:V-Monitor Fn000:Alm History Fn001:JOG           </pre>		<p>Press the  Key.</p> <p>The display returns to the main menu of the utility function.</p>

### (3) Related Parameters

The following table lists parameters related to this function and their possibility of being changed while executing this function or of being changed automatically after executing this function.

- Parameters related to this function

These are parameters that are used or referenced when executing this function.

- Allowed changes during execution of this function

Yes : Parameters can be changed using SigmaWin+ while this function is being executed.

No : Parameters cannot be changed using SigmaWin+ while this function is being executed.

- Automatic changes after execution of this function

Yes : Parameter set values are automatically set or adjusted after execution of this function.

No : Parameter set values are not automatically set or adjusted after execution of this function.

Parameter	Name	Mid-execution changes	Automatic changes
<b>Pn401</b>	Force Reference Filter Time Constant	No	Yes
<b>Pn408</b>	Force Related Function Switch	Yes	Yes
<b>Pn409</b>	1st Notch Filter Frequency	No	Yes
<b>Pn40A</b>	1st Notch Filter Q Value	No	No
<b>Pn40C</b>	2nd Notch Filter Frequency	No	No
<b>Pn40D</b>	2nd Notch Filter Q Value	No	No

## Monitor Displays (Un□□□)

7.1 List of Monitor Displays .....	7-2
7.2 Viewing Monitor Displays .....	7-3
7.3 Monitoring Input Signals .....	7-4
7.3.1 Interpreting Input Signal Display Status .....	7-4
7.3.2 Input Signal Display Example .....	7-5
7.4 Monitoring Output Signals .....	7-6
7.4.1 Interpreting Output Signal Display Status .....	7-6
7.4.2 Output Signal Display Example .....	7-6
7.5 Monitoring Safety Input Signals .....	7-7
7.5.1 Interpreting Safety Input Signal Display Status .....	7-7
7.5.2 Safety Input Signal Display Example .....	7-7

## 7.1 List of Monitor Displays

The monitor displays can be used for monitoring the I/O signal status, and SERVOPACK internal status.

Refer to the following table.

Parameter No.	Description	Unit
Un000	Motor moving speed	mm/s
Un001	Speed reference	mm/s
Un002	Internal force reference (percentage of the rated force)	%
Un003	Electric angle 1 (number of linear-scale pulses from polarity origin: decimal display)	linear scale pulse <sup>*1</sup>
Un004	Electric angle 2 (from polarity origin)	deg
Un005 <sup>*2</sup>	Input signal monitor	–
Un006 <sup>*3</sup>	Output signal monitor	–
Un007	Input reference pulse speed (valid only in position control)	mm/s
Un008	Position error amount (valid only in position control)	reference unit
Un009	Accumulated load ratio (in percentage to the rated force: effective force in cycle of 10 seconds)	%
Un00A	Regenerative load ratio (as a percentage of the processable regenerative power: regenerative power consumption in cycle of 10 seconds)	%
Un00B	Power consumed by DB resistance (in percentage to the processable power at DB activation: displayed in cycle of 10 seconds)	%
Un00C	Input reference pulse counter	reference unit
Un00D	Feedback pulse counter	linear scale pulse <sup>*1</sup>
Un010	Allowable motor maximum speed and encoder output resolution	–
Un011	Hall sensor signal	–
Un012	Total operation time	100 ms
Un013	Feedback pulse counter	reference unit
Un014	Effective gain monitor (gain settings 1 = 1, gain settings 2 = 2)	–
Un015	Safety I/O signal monitor	–
Un020	Motor rated speed	mm/s
Un021	Motor maximum speed	mm/s
Un084	Linear scale pitch (Scale pitch = $Un084 \times 10^{Un085}$ [pm])	–
Un085	Linear scale pitch index (Scale pitch = $Un084 \times 10^{Un085}$ [pm])	–

\*1. For details, refer to 4.2.4 *Electronic Gear*.

\*2. For details, refer to 7.3 *Monitoring Input Signals*.

\*3. For details, refer to 7.4 *Monitoring Output Signals*.

## 7.2 Viewing Monitor Displays

The monitor display can be checked or viewed in the Parameter/Monitor (-PRM/MON-) window of the digital operator.

The following figure shows four factory settings that are first displayed if viewing monitor displays.

BB	-PRM/MON-
Un00 <u>0</u>	= 00000
Un00 <u>2</u>	= 00000
Un00 <u>8</u>	= 00000
Un00 <u>D</u>	= 00000000

← Indicates that the value of Un000 (motor moving speed) is 0 mm/s.

To view any items that are not shown, press the  or  Key to scroll through the list.

Motor moving speed	Un00 <u>0</u> = 00000
	<input type="button" value="▼"/> ↑ ↓ <input type="button" value="▲"/>
Speed reference	Un00 <u>1</u> = 00000
	<input type="button" value="▼"/> ↑ ↓ <input type="button" value="▲"/>
Internal force reference	Un00 <u>2</u> = 00000
	<input type="button" value="▼"/> ↑ ↓ <input type="button" value="▲"/>
Electric angle 1 (number of linear-scale pulses from polarity origin)	Un00 <u>3</u> = 00000
	<input type="button" value="▼"/> ↑ ↓ <input type="button" value="▲"/>
Electric angle 2 (from polarity origin)	Un00 <u>4</u> = 00090
	<input type="button" value="▼"/> ↑ ↓ <input type="button" value="▲"/>
	⋮
	<input type="button" value="▼"/> ↑ ↓ <input type="button" value="▲"/>
Feedback pulse counter	Un00 <u>D</u> = 00000000

## 7.3 Monitoring Input Signals

The status of input signals can be checked with the input signal monitor (Un005). The procedure for the method of interpreting the display and a display example are shown below.

### 7.3.1 Interpreting Input Signal Display Status

The input signal monitor (Un005) can be read in the following way. The upper level indicates OFF, and the lower level indicates ON. All undefined digits are shown in the lower level (ON).

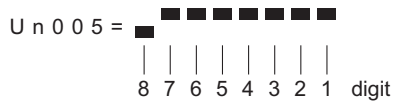

Display LED Number	Input Terminal Name	Signal Name (Factory Setting)
1	CN1-13	/SI0
2	CN1-7	P-OT
3	CN1-8	N-OT
4	CN1-9	/SI3
5	CN1-10	/SI4
6	CN1-11	/SI5
7	CN1-12	/SI6
8	—	Reserved

**<NOTE>**

Input signals use the following circuit configuration.

OFF: Open

ON: Short-circuited

Example

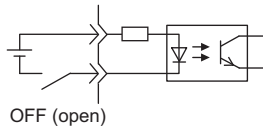

### 7.3.2 Input Signal Display Example

Input signals are displayed as shown below.

- When the /SI3 signal is ON

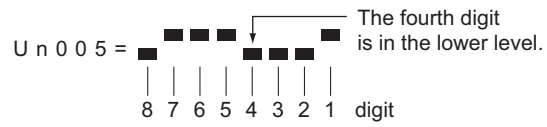

- When the /SI3 signal is OFF

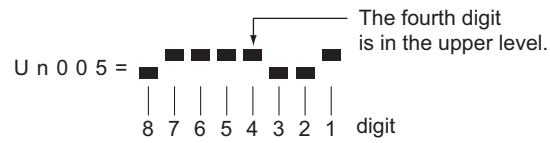

- When the P-OT signal is activated

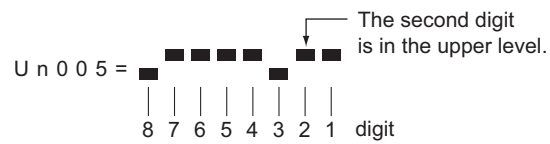

## 7.4 Monitoring Output Signals

The status of output signals can be checked with the output signal monitor (Un006). The procedure for the method of interpreting the display and a display example are shown below.

### 7.4.1 Interpreting Output Signal Display Status

The output signal monitor (Un006) can be read in the following way. The upper level indicates OFF, and the lower level indicates ON. All undefined digits are shown in the lower level (ON).

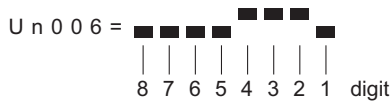

Display LED Number	Output Terminal Name	Signal Name (Factory Setting)
1	CN1-3, -4	ALM
2	CN1-1, -2	/BK
3	CN1-23, -24	SO2
4	CN1-25, -26	SO3
5	—	Reserved
6	—	Reserved
7	—	Reserved
8	—	Reserved

<NOTE>

Output signals use the following circuit configuration.

OFF: Transistor OFF

ON: Transistor ON

Example

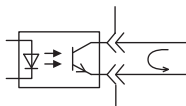

ON: Transistor ON

### 7.4.2 Output Signal Display Example

Output signals are displayed as shown below.

- When the ALM signal is OFF

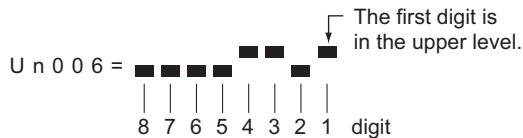

## 7.5 Monitoring Safety Input Signals

The status of safety input signals can be checked with the safety I/O signal monitor (Un015). The procedure for the method of interpreting the display and a display example are shown below.

### 7.5.1 Interpreting Safety Input Signal Display Status

The safety I/O signal monitor (Un015) can be read in the following way. The upper level indicates ON, and the lower level indicates OFF. All undefined digits are shown in the lower level (OFF).

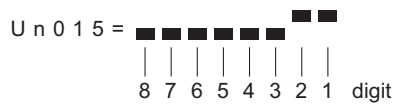

Display LED Number	Input Terminal Name	Signal Name
1	CN8-3, -4	/HWBB1
2	CN8-5, -6	/HWBB2
3	—	Reserved
4	—	Reserved
5	—	Reserved
6	—	Reserved
7	—	Reserved
8	—	Reserved

Note: Input signals use the following circuit configuration.

- OFF: Open
- ON: Short-circuited

Example

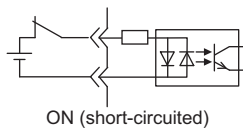

### 7.5.2 Safety Input Signal Display Example

Safety input signals are displayed as shown below.

- When the /HWBB1 signal turns OFF to activate the HWBB function

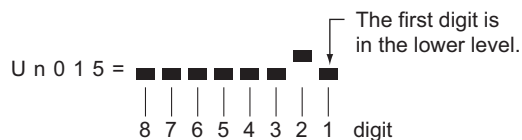

---

## Troubleshooting

8.1 Alarm Displays .....	8-2
8.1.1 List of Alarms .....	8-2
8.1.2 Troubleshooting of Alarms .....	8-7
8.2 Warning Displays .....	8-25
8.2.1 List of Warnings .....	8-25
8.2.2 Troubleshooting of Warnings .....	8-26
8.3 Troubleshooting Malfunction Based on Operation and Conditions of the Servomotor .....	8-30

## 8.1 Alarm Displays

The following sections describe troubleshooting in response to alarm displays.

The alarm name, alarm meaning, alarm stopping method, and alarm reset capability are listed in order of the alarm numbers in *8.1.1 List of Alarms*.

The causes of alarms and troubleshooting methods are provided in *8.1.2 Troubleshooting of Alarms*.

### 8.1.1 List of Alarms

This section provides list of alarms.

#### ■ Servomotor Stopping Method

If an alarm occurs, the servomotor can be stopped by doing either of the following operations.

Gr.1: The servomotor is stopped according to the setting in Pn001.0 if an alarm occurs. Pn001.0 is factory-set to stop the servomotor by applying the DB.

Gr.2: The servomotor is stopped according to the setting in Pn00B.1 if an alarm occurs. Pn00B.1 is factory-set to stop the servomotor by setting the speed reference to "0." The servomotor under force control will always use the Gr.1 method to stop. By setting Pn00B.1 to 1, the servomotor stops using the same method as Gr.1. When coordinating a number of servomotors, use this stopping method to prevent machine damage that may result due to differences in the stop method.

#### ■ Alarm Reset

Available: Removing the cause of alarm and then executing the alarm reset can clear the alarm.

N/A: Executing the alarm reset cannot clear the alarm.

Alarm Number	Alarm Name	Meaning	Servo-motor Stopping Method	Alarm Reset
A.020	Parameter Checksum Error 1	The data of the parameter in the SERVOPACK is incorrect.	Gr.1	N/A
A.021	Parameter Format Error 1	The data of the parameter in the SERVOPACK is incorrect.	Gr.1	N/A
A.022	System Checksum Error 1	The data of the parameter in the SERVOPACK is incorrect.	Gr.1	N/A
A.030	Main Circuit Detector Error	Detection data for main circuit is incorrect.	Gr.1	Available
A.040	Parameter Setting Error 1	The parameter setting is outside the setting range.	Gr.1	N/A
A.041	Encoder Output Pulse Setting Error	The encoder output resolution (Pn281) is outside the setting range or does not satisfy the setting conditions.	Gr.1	N/A
A.042	Parameter Combination Error	Combination of some parameters exceeds the setting range.	Gr.1	N/A
A.04A	Parameter Setting Error 2	There is an error in settings of parameters reserved by the system.	Gr.1	N/A
A.050	Combination Error	The SERVOPACK and the servomotor capacities do not match each other.	Gr.1	Available
A.051	Unsupported Device Alarm	The device unsupported was connected.	Gr.1	N/A
A.080	Linear Scale Pitch Setting Error	The setting of the linear scale pitch (Pn282) has not been changed from the default setting.	Gr.1	N/A
A.0b0	Canceled Servo ON Command Alarm	The servo ON command was sent from the host controller after executing a utility function that turns ON the servomotor.	Gr.1	Available
A.100	Overcurrent or Heat Sink Overheated	An overcurrent flowed through the IGBT or the heat sink of the SERVOPACK was overheated.	Gr.1	N/A
A.300	Regeneration Error	Regenerative circuit or regenerative resistor is faulty.	Gr.1	Available

(cont'd)

Alarm Number	Alarm Name	Meaning	Servo-motor Stopping Method	Alarm Reset
A.320	Regenerative Overload	Regenerative energy exceeds regenerative resistor capacity.	Gr.2	Available
A.330	Main Circuit Power Supply Wiring Error	<ul style="list-style-type: none"> <li>Setting of AC input/DC input is incorrect.</li> <li>Power supply wiring is incorrect.</li> </ul>	Gr.1	Available
A.400	Overvoltage	Main circuit DC voltage is excessively high.	Gr.1	Available
A.410	Undervoltage	Main circuit DC voltage is excessively low.	Gr.2	Available
A.450	Main-Circuit Capacitor Overvoltage	The capacitor of the main circuit has deteriorated or is faulty.	Gr.1	N/A
A.510	Overspeed	The servomotor speed is above the maximum speed.	Gr.1	Available
A.511	Overspeed of Encoder Output Pulse Rate	The motor speed upper limit of the set encoder output resolution (Pn281) is exceeded.	Gr.1	Available
A.520	Vibration Alarm	Incorrect vibration at the motor speed was detected.	Gr.1	Available
A.521	Autotuning Alarm	Vibration was detected while performing tuning-less function.	Gr.1	Available
A.550	Maximum Speed Setting Error	The Pn385 setting is greater than the maximum speed.	Gr.1	Available
A.710	Overload: High Load	The servomotor was operating for several seconds to several tens of seconds under a force largely exceeding ratings.	Gr.2	Available
A.720	Overload: Low Load	The servomotor was operating continuously under a force exceeding ratings.	Gr.1	Available
A.730 A.731	Dynamic Brake Overload	When the dynamic brake was applied, moving energy exceeded the capacity of dynamic brake resistor.	Gr.1	Available
A.740	Overload of Surge Current Limit Resistor	The main circuit power was frequently turned ON and OFF.	Gr.1	Available
A.7A0	Heat Sink Overheated	The heat sink of the SERVOPACK exceeded 100°C.	Gr.2	Available
A.7Ab	Built-in Fan in SERVOPACK Stopped	The fan inside the SERVOPACK stopped.	Gr.1	Available
A.820	Encoder Checksum Error	The checksum results of linear scale memory is incorrect.	Gr.1	N/A
A.840	Encoder Data Error	Data in the linear scale is incorrect.	Gr.1	N/A
A.850	Encoder Overspeed	The linear scale was moving at high speed when the power was turned ON.	Gr.1	N/A
A.860	Encoder Overheated	The internal temperature of linear scale is too high.	Gr.1	N/A
A.861	Motor Overheated	The internal temperature of motor is too high.	Gr.1	N/A
A.890	Encoder Scale Error	A linear scale fault occurred	Gr.1	N/A
A.891	Encoder Module Error	Linear scale is faulty.	Gr.1	N/A
A.b31	Current Detection Error 1	The current detection circuit for phase U is faulty.	Gr.1	N/A
A.b32	Current Detection Error 2	The current detection circuit for phase V is faulty.	Gr.1	N/A
A.b33	Current Detection Error 3	The detection circuit for the current is faulty.	Gr.1	N/A
A.bE0	Firmware Error	An internal program error occurred in the SERVOPACK.	Gr.1	N/A
A.bF0	System Alarm 0	Internal program error 0 occurred in the SERVOPACK.	Gr.1	N/A
A.bF1	System Alarm 1	Internal program error 1 occurred in the SERVOPACK.	Gr.1	N/A
A.bF2	System Alarm 2	Internal program error 2 occurred in the SERVOPACK.	Gr.1	N/A

(cont'd)

Alarm Number	Alarm Name	Meaning	Servo-motor Stopping Method	Alarm Reset
<b>A.bF3</b>	System Alarm 3	Internal program error 3 occurred in the SERVO-PACK.	Gr.1	N/A
<b>A.bF4</b>	System Alarm 4	Internal program error 4 occurred in the SERVO-PACK.	Gr.1	N/A
<b>A.C10</b>	Servo Overrun Detected	The servomotor ran out of control.	Gr.1	Available
<b>A.C20</b>	Phase Detection Error	The detection of the phase is incorrect.	Gr.1	N/A
<b>A.C21</b>	Hall Sensor Error	The hall sensor is faulty.	Gr.1	N/A
<b>A.C22</b>	Phase Information Disagreement	The phase information does not match.	Gr.1	N/A
<b>A.C50</b>	Polarity Detection Error	The polarity detection failed.	Gr.1	N/A
<b>A.C51</b>	Overtravel Detection at Polarity Detection	The overtravel signal was detected at polarity detection.	Gr.1	Available
<b>A.C52</b>	Polarity Detection Uncompleted	The servomotor was turned ON under the condition of polarity detection uncompleted.	Gr.1	Available
<b>A.C53</b>	Out of Range for Polarity Detection	The moving distance exceeded the set value of Pn48E during polarity detection.	Gr.1	N/A
<b>A.C54</b>	Polarity Detection Error 2	The polarity detection failed.	Gr.1	N/A
<b>A.C80</b>	Absolute Encoder Clear Error	The absolute linear scale data was cleared or the setting is not correct.	Gr.1	N/A
<b>A.C90</b>	Encoder Communications Error	Communications between the SERVOPACK and the linear scale is not possible.	Gr.1	N/A
<b>A.C91</b>	Encoder Communications Position Data Error	A linear scale position data calculation error occurred.	Gr.1	N/A
<b>A.C92</b>	Encoder Communications Timer Error	An error occurs in the communications timer between the linear scale and the SERVOPACK.	Gr.1	N/A
<b>A.CA0</b>	Encoder Parameter Error	Linear scale parameters are faulty.	Gr.1	N/A
<b>A.Cb0</b>	Encoder Echoback Error	Contents of communications with linear scale are incorrect.	Gr.1	N/A
<b>A.CF1</b>	Feedback Option Module Communications Error (Reception error)	Reception from the feedback option module is faulty.	Gr.1	N/A
<b>A.CF2</b>	Feedback Option Module Communications Error (Timer stop)	Timer for communications with the feedback option module is faulty.	Gr.1	N/A
<b>A.d00</b>	Position Error Overflow	Position error exceeded the value of excessive position error alarm level (Pn520) when the servomotor power is ON.	Gr.1	Available
<b>A.d01</b>	Position Error Overflow Alarm at Servo ON	This alarm occurs if the servomotor power is turned ON when the position error is greater than the set value of Pn526 while the servomotor power is OFF.	Gr.1	Available
<b>A.d02</b>	Position Error Overflow Alarm by Speed Limit at Servo ON	When the position errors remain in the error counter, Pn584 limits the speed if the servomotor power is turned ON. If Pn584 limits the speed in such a state, this alarm occurs when position references are input and the number of position errors exceeds the value set for the excessive position error alarm level (Pn520).	Gr.2	Available
<b>A.d30</b>	Position Data Overflow	The position feedback data exceeded $\pm 1879048192$ .	Gr.1	N/A
<b>A.E00</b>	Command Option Module IF Initialization Timeout Error	Communications initialization failed between the SERVOPACK and the command option module.	Gr.2	Available
<b>A.E02</b>	Command Option Module IF Synchronization Error 1	An error occurred in synchronization between the SERVOPACK and the command option module.	Gr.1	Available

(cont'd)

Alarm Number	Alarm Name	Meaning	Servo-motor Stopping Method	Alarm Reset
A.E03	Command Option Module IF Communications Data Error	An error occurred in the data of communications between the SERVOPACK and the command option module.	Gr.1	Available
A.E40	Command Option Module IF Communications Setting Error	An error occurred in establishing communications (settings) between the SERVOPACK and the command option module.	Gr.2	Available
A.E50	Command Option Module IF Synchronization Error 2	An error occurred in synchronization between the SERVOPACK and the command option module.	Gr.2	Available
A.E51	Command Option Module IF Synchronization Establishment Error	An error occurred in establishing communications between the SERVOPACK and the command option module.	Gr.2	Available
A.E60	Command Option Module IF Data Communications Error	An error occurred in communications between the SERVOPACK and the command option module.	Gr.2	Available
A.E61	Command Option Module IF Synchronization Error 3	There was a change in timing of synchronization between the SERVOPACK and the command option module.	Gr.2	Available
A.E70	Command Option Module Detection Failure	Detection of the command option module failed.	Gr.1	N/A
A.E71	Safety Option Module Detection Failure	Detection of the safety option module failed.	Gr.1	N/A
A.E72	Feedback Option Module Detection Failure	Detection of the feedback option module failed.	Gr.1	N/A
A.E73	Unsupported Command Option Module	An unsupported command option module was connected.	Gr.1	N/A
A.E74	Unsupported Safety Option Module	An unsupported safety option module was connected.	Gr.1	N/A
A.E75	Unsupported Feedback Option Module	An unsupported feedback option module was connected.	Gr.1	N/A
A.E80	Command Option Module Unmatched Error	The command option module was replaced with a different model.	Gr.1	N/A
A.E81 <sup>*1</sup>	SERVOPACK: Safety Module Alarm	–	–	–
A.EA2	DRV Alarm 2 (SERVOPACK WDC error)	A SERVOPACK DRV alarm 0 occurs.	Gr.2	Available
A.Eb1	Safety Function Signal Input Timing Error	The safety function signal input timing is faulty.	Gr.1	N/A
A.Eb□ <sup>*1</sup>	SERVOPACK: Safety Module Alarms	–	–	–
A.EC□ <sup>*1</sup>				
A.Ed1	Command Option Module IF Command Timeout Error	Processing of reference from the command option module was not completed.	Gr.2	Available
A.F10	Main Circuit Cable Open Phase	A low voltage continued for one second or longer in either phase R, S, or T when the main circuit power supply was ON.	Gr.2	Available
A.F50	Servomotor Main Circuit Cable Disconnection	The servomotor did not operate or power was not supplied to the servomotor even though the servo ON command was input when the servomotor was ready to receive it.	Gr.1	Available
FL-1 <sup>*2</sup>	System Alarm	Internal program error occurred in the SERVOPACK	–	N/A
FL-2 <sup>*2</sup>				

(cont'd)

Alarm Number	Alarm Name	Meaning	Servo-motor Stopping Method	Alarm Reset
<b>CPF00</b>	Digital Operator Transmission Error 1	Communications cannot be performed between the digital operator (model: JUSP-OP05A-1-E) and the SERVOPACK (CPU error or other error).	-	N/A
<b>CPF01</b>	Digital Operator Transmission Error 2			

\*1. These alarms occur in SERVOPACKs with safety modules. For details, refer to the *Σ-V Series AC Servo Drives User's Manual Safety Module* (Manual No. SIEP C720829 06).

\*2. These alarms are not saved in the alarm history. There are displayed only on the panel display.

## 8.1.2 Troubleshooting of Alarms

If an error occurs in the servo drive, an alarm A.□□□ or CPF□□ is displayed on the panel display.

Refer to the following table to identify the cause of an alarm and the action to be taken.

Contact your Yaskawa representative if the problem cannot be solved by the described corrective action.

Alarm Number: Alarm Name	Cause	Investigative Actions	Corrective Actions
A.020: Parameter Checksum Error 1 (The parameter data in the SERVOPACK is incorrect.)	The power supply voltage suddenly dropped.	Measure the power supply voltage.	Set the power supply voltage within the specified range, and set Fn005 to initialize the parameter.
	The power supply went OFF while changing a parameter setting.	Check the circumstances when the power supply went OFF.	Set Fn005 to initialize the parameter and then set the parameter again.
	The number of times that parameters were written exceeded the limit.	Check to see if the parameters were frequently changed through the host controller.	The SERVOPACK may be faulty. Replace the SERVOPACK. Reconsider the method of writing parameters.
	Malfunction caused by noise from the AC power supply or grounding line, static electricity noise, etc.	Turn the power supply to the SERVOPACK OFF and ON again. If the alarm still occurs, the cause may be noise.	Take countermeasures against noise.
	Gas, water drops, or cutting oil entered the SERVOPACK and caused failure of the internal components.	Check the installation conditions.	The SERVOPACK may be faulty. Replace the SERVOPACK.
	A SERVOPACK fault occurred.	Turn the power supply to the SERVOPACK OFF and ON again. If the alarm still occurs, the SERVOPACK may be faulty.	The SERVOPACK may be faulty. Replace the SERVOPACK.
A.021: Parameter Format Error 1 (The parameter data in the SERVOPACK is incorrect.)	The software version of SERVOPACK that caused the alarm is older than that of the written parameter.	Check Fn012 to see if the set software version agrees with that of the SERVOPACK. If not, an alarm may occur.	Write the parameter of another SERVOPACK of the same model with the same software version. Then turn the power OFF and then ON again.
	A SERVOPACK fault occurred.	–	The SERVOPACK may be faulty. Replace the SERVOPACK.
A.022: System Checksum Error 1 (The parameter data in the SERVOPACK is incorrect.)	The power supply voltage suddenly dropped.	Measure the power supply voltage.	The SERVOPACK may be faulty. Replace the SERVOPACK.
	The power supply went OFF while setting an utility function.	Check the circumstances when the power supply went OFF.	The SERVOPACK may be faulty. Replace the SERVOPACK.
	A SERVOPACK fault occurred.	Turn the power supply to the SERVOPACK OFF and ON again. If the alarm still occurs, the SERVOPACK may be faulty.	The SERVOPACK may be faulty. Replace the SERVOPACK.
A.030: Main Circuit Detector Error	A SERVOPACK fault occurred.	–	The SERVOPACK may be faulty. Replace the SERVOPACK.
A.040: Parameter Setting Error 1 (The parameter setting was out of the setting range.)	The SERVOPACK and servomotor capacities do not match each other.	Check the combination of SERVOPACK and servomotor capacities.	Select the proper combination of SERVOPACK and servomotor capacities.
	A SERVOPACK fault occurred.	–	The SERVOPACK may be faulty. Replace the SERVOPACK.
	The parameter setting is out of the setting range.	Check the setting ranges of the parameters that have been changed.	Set the parameter to a value within the setting range.
	The electronic gear ratio is out of the setting range.	Check the electronic gear ratio. The ratio must satisfy: $0.001 < (Pn20E/Pn210) < 4000$ .	Set the electronic gear ratio in the range: $0.001 < (Pn20E/Pn210) < 4000$ .
A.041: Encoder Output Pulse Setting Error	The encoder output resolution (Pn281) is out of the setting range and does not satisfy the setting conditions.	Check the parameter Pn281.	Set Pn281 to a correct value.

(cont'd)

Alarm Number: Alarm Name	Cause	Investigative Actions	Corrective Actions
A.042: Parameter Combination Error	The speed of program JOG operation (Fn004) is lower than the setting range after having changed the electronic gear ratio (Pn20E/Pn210) or the servomotor.	Check if the detection conditions are satisfied.* <sup>1</sup>	Decrease the setting of the electronic gear ratio (Pn20E/Pn210).
	The speed of program JOG operation (Fn004) is lower than the setting range after having changed the setting of the program JOG movement speed (Pn585).	Check if the detection conditions are satisfied.* <sup>1</sup>	Increase the setting of the program JOG movement speed (Pn585).
	The moving speed of advanced autotuning is lower than the setting range after having changed the electronic gear ratio (Pn20E/Pn210) or the servomotor.	Check if the detection conditions are satisfied.* <sup>2</sup>	Decrease the setting of the electronic gear ratio (Pn20E/Pn210).
A.04A: Parameter Setting Error 2	A parameter reserved by the system was changed.	Check the set values of reserved parameters.	Change the set values of reserved parameters to the factory settings.
A.050: Combination Error (The SERVOPACK and servomotor capacities do not correspond.)	The SERVOPACK and servomotor capacities do not match each other.	Check the capacities to see if they satisfy the following condition: $\frac{1}{4} \leq \frac{\text{Servomotor capacity}}{\text{SERVOPACK capacity}} \leq 4$	Select the proper combination of SERVOPACK and servomotor capacities.
	A linear scale fault occurred.	Replace the linear scale and see if the alarm occurs again.	Replace the linear scale.
	A SERVOPACK fault occurred.	–	The SERVOPACK may be faulty. Replace the SERVOPACK.
A.051: Unsupported Device Alarm	The parameters of the motor parameter file are not written in the linear scale. (Only when not using serial converter units)	Check if the parameters of the motor parameter file are written in the linear scale.	Write the parameters of the motor parameter file in the linear scale.
	An unsupported serial converter unit or linear scale is connected to the SERVOPACK.	Check the product specifications, and select the correct model.	Select the correct combination of units.
A.080: Linear Scale Pitch Setting Error	The setting of the linear scale pitch (Pn282) has not been changed from the default setting.	Check the value of Pn282.	Correct the value of Pn282.
A.0b0: Canceled Servo ON Command Alarm	After executing the utility function to turn ON the power to the motor, the servo ON command was input from the host controller.	–	Turn the SERVOPACK power supply OFF and then ON again or execute a software reset.

(cont'd)

Alarm Number: Alarm Name	Cause	Investigative Actions	Corrective Actions
A.100: Overcurrent or Heat Sink Overheated (An overcurrent flowed through the IGBT or heat sink of SERVOPACK overheated.)	Incorrect wiring or contact fault of main circuit cables.	Check the wiring. Refer to <i>3.1 Main Circuit Wiring</i> for details.	Correct the wiring.
	Short-circuit or ground fault of main circuit cables.	Check for short-circuits across the servomotor terminal phases U, V, and W, or between the grounding and servomotor terminal phases U, V, or W. Refer to <i>3.1 Main Circuit Wiring</i> for details.	The cable may be short-circuited. Replace the cable.
	Short-circuit or ground fault inside the servomotor.	Check for short-circuits across the servomotor terminal phases U, V, and W, or between the grounding and servomotor terminal phases U, V, or W. Refer to <i>3.1 Main Circuit Wiring</i> for details.	The servomotor may be faulty. Replace the servomotor.
	Short-circuit or ground fault inside the SERVOPACK.	Check for short-circuits across the servomotor connection terminals U, V, and W on the SERVOPACK, or between the grounding and terminal U, V, or W. Refer to <i>3.1 Main Circuit Wiring</i> for details.	The SERVOPACK may be faulty. Replace the SERVOPACK.
	Incorrect wiring or contact fault of the regenerative resistor.	Check the wiring. Refer to <i>3.7 Connecting Regenerative Resistors</i> for details.	Correct the wiring.
	The dynamic brake (DB: Emergency stop executed from the SERVOPACK) was frequently activated, or the DB overload alarm occurred.	Check the power consumed by DB resistance (Un00B) to see how many times the DB has been used. Or, check the alarm history display Fn000 to see if the DB overload alarm A.730 or A.731 was reported.	Change the SERVOPACK model, operating conditions, or the mechanism so that the DB does not need to be used so frequently.
	The generated regenerative resistor value exceeded the SERVOPACK regenerative energy processing capacity.	Check the regenerative load ratio (Un00A) to see how many times the regenerative resistor has been used.	Check the operating condition including overload, and reconsider the regenerative resistor value.
	The SERVOPACK regenerative resistance is too small.	Check the regenerative load ratio (Un00A) to see how many times the regenerative resistor has been used.	Change the regenerative resistance value to a value larger than the SERVOPACK minimum allowable resistance value.
	A heavy load was applied while the servomotor was stopped or running at a low speed.	Check to see if the operating conditions are outside servo drive specifications.	Reduce the load applied to the servomotor or increase the operating speed.
	Malfunction caused by noise interference.	Improve the wiring or installation environment, such as by reducing noise, and check to see if the alarm recurs.	Take countermeasures for noise, such as correct wiring of the FG. Use an FG wire size equivalent to the SERVOPACK main circuit wire size.
A SERVOPACK fault occurred.	—	Turn the power supply to the SERVOPACK OFF and ON again. If the alarm still occurs, the SERVOPACK may be faulty. Replace the SERVOPACK.	

(cont'd)

Alarm Number: Alarm Name	Cause	Investigative Actions	Corrective Actions
A.300: Regeneration Error	The regenerative resistor capacity (Pn600) is set to a value other than 0 for a SGD V-R70F, -R90F, -2R1F, -R70A, -R90A, -1R6A, or -2R8A SERVOPACK, and an external regenerative resistor is not connected.	Check the external regenerative resistor connection and the value of the Pn600.	Connect the external regenerative resistor, or set Pn600 to 0 if no regenerative resistor is required.
	An external regenerative resistor is not connected to the SGD V-550A, -260D SERVOPACK.	Check the connection of the external regenerative resistor or the Yaskawa regenerative resistor unit and the set value in Pn600.	Connect an external regenerative resistor and set Pn600 to the appropriate value, or connect a Yaskawa regenerative resistor unit and set Pn600 to 0.
	The jumper between the power supply terminals B2 and B3 has been removed for one of these SERVOPACKs: SGD V-3R8A, -5R5A, -7R6A, -120A, -180A, -200A, -330A, -1R9D, -3R5D, -5R4D, -8R4D, -120D, and -170D.	Confirm that a jumper is mounted between the power supply terminals B2 and B3.	Correctly mount a jumper.
	The external regenerative resistor is incorrectly wired, or is removed or disconnected.	Check the external regenerative resistor connection.	Correctly connect the external regenerative resistor.
	A SERVOPACK fault occurred.	–	Turn the SERVOPACK's control power supply OFF and ON again while the main circuit power supply is OFF. If the alarm still occurs, the SERVOPACK may be faulty. Replace the SERVOPACK.
A.320: Regenerative Overload	The power supply voltage exceeds the specified limit.	Measure the power supply voltage.	Set the power supply voltage within the specified range.
	Insufficient external regenerative resistance, regenerative resistor capacity, or SERVOPACK capacity. Or, regenerative power has been continuously flowing back.	Check the operating condition or the capacity using the capacity selection Software SigmaJunma-Size+, etc.	Change the regenerative resistance, regenerative resistor capacity, or SERVOPACK capacity. Reconsider the operating conditions using the capacity selection software SigmaJunmaSize+, etc.
	Regenerative power continuously flowed back because negative load was continuously applied.	Check the load applied to the servomotor during operation.	Reconsider the system including servo, machine, and operating conditions.
	The setting of parameter Pn600 is smaller than the external regenerative resistor's capacity.	Check the external regenerative resistor connection and the value of the Pn600.	Set the Pn600 to a correct value.
	The external regenerative resistance is too high.	Check the regenerative resistance.	Change the regenerative resistance to a correct value or use an external regenerative resistor of appropriate capacity.
	A SERVOPACK fault occurred.	–	The SERVOPACK may be faulty. Replace the SERVOPACK.

(cont'd)

Alarm Number: Alarm Name	Cause	Investigative Actions	Corrective Actions
A.330: Main Circuit Power Supply Wiring Error (Detected when the main circuit power supply is turned ON.)	The regenerative resistor disconnected when the SERVOPACK power supply voltage was high.	Measure the resistance of the regenerative resistor using a measuring instrument.	When using a regenerative resistor built in the SERVOPACK: Replace the SERVOPACK. When using an external regenerative resistor: Replace the external regenerative resistor.
	In the AC power input mode, DC power was supplied.	Check the power supply to see if it is a DC power supply.	Correct the settings to match the actual power supply specifications.
	In the DC power input mode, AC power was supplied.	Check the power supply to see if it is an AC power supply.	Correct the settings to match the actual power supply specifications.
	The regenerative resistor capacity (Pn600) is set to a value other than 0 for a SGD V-R70F, -R90F, -2R1F, -R70A, -R90A, -1R6A, or -2R8A SERVOPACK, and an external regenerative resistor is not connected.	Check the external regenerative resistor connection and the value of the Pn600.	Connect the external regenerative resistor, or set Pn600 to 0 if no external regenerative resistor is required.
	An external regenerative resistor is not connected to the SGD V-550A, -260D SERVOPACK.	Check the connection of the external regenerative resistor or the Yaskawa regenerative resistor unit and the set value in Pn600.	Connect an external regenerative resistor and set Pn600 to the appropriate value, or connect a Yaskawa regenerative resistor unit and set Pn600 to 0.
	The jumper between the power supply terminals B2 and B3 has been removed for one of these SERVOPACKs: SGD V-3R8A, -5R5A, -7R6A, -120A, -180A, -200A, -330A, -1R9D, -3R5D, -5R4D, -8R4D, -120D, and -170D.	Confirm that a jumper is mounted between the power supply terminals B2 and B3.	Correctly mount a jumper.
	A SERVOPACK fault occurred.	—	The SERVOPACK may be faulty. Replace the SERVOPACK.
A.400: Overvoltage (Detected in the SER- VOPACK main circuit power supply section.)	<ul style="list-style-type: none"> <li>For 100-VAC SERVOPACKs: The AC power supply voltage exceeded 145 V.</li> <li>For 200-VAC SERVOPACKs: The AC power supply voltage exceeded 290 V.</li> <li>For 400-VAC SERVOPACKs: The AC power supply voltage exceeded 580 V.</li> <li>For 200-VAC SERVOPACKs: with DC power supply input: The DC power supply voltage exceeded 410 V.</li> <li>For 400-VAC SERVOPACKs: The DC power supply voltage exceeded 820 V.</li> </ul>	Measure the power supply voltage.	Set AC/DC power supply voltage within the specified range.
	The power supply is unstable, or was influenced by a lightning surge.	Measure the power supply voltage.	Improve the power supply conditions, e.g., by installing a surge absorber. Then, turn the SERVOPACK power supply OFF and ON again. If the alarm still occurs, the SERVOPACK may be faulty. Replace the SERVOPACK.
	Voltage for AC power supply was too high during acceleration or deceleration.	Check the power supply voltage and the speed and force during operation.	Set AC power supply voltage within the specified range.
	The external regenerative resistance is too high for the actual operating conditions.	Check the operating conditions and the regenerative resistance.	Select a regenerative resistance value appropriate for the operating conditions and load.
	The mass ratio exceeded the allowable value.	Confirm that the mass ratio is within the allowable range.	Increase the deceleration time, or reduce the load.
	A SERVOPACK fault occurred.	—	Turn the SERVOPACK's control power supply OFF and ON again while the main circuit power supply is OFF. If the alarm still occurs, the SERVOPACK may be faulty. Replace the SERVOPACK.

(cont'd)

Alarm Number: Alarm Name	Cause	Investigative Actions	Corrective Actions
A.410: Undervoltage (Detected in the SERVOPACK main circuit power supply section.)	<ul style="list-style-type: none"> <li>For 100-VAC SERVOPACKs: The AC power supply voltage is 49 V or less.</li> <li>For 200-VAC SERVOPACKs: The AC power supply voltage is 120 V or less.</li> <li>For 400-VAC SERVOPACKs: The AC power supply voltage is 240 V or less.</li> </ul>	Measure the power supply voltage.	Set the power supply voltage within the specified range.
	The power supply voltage dropped during operation.	Measure the power supply voltage.	Increase the power supply capacity.
	Occurrence of instantaneous power interruption.	Measure the power supply voltage.	When the instantaneous power cut hold time (Pn509) is set, decrease the setting.
	The SERVOPACK fuse is blown out.	–	Replace the SERVOPACK, connect a reactor, and run the SERVOPACK.
	A SERVOPACK fault occurred.	–	The SERVOPACK may be faulty. Replace the SERVOPACK.
A.450: Main-Circuit Capacitor Overvoltage	A SERVOPACK fault occurred.	–	Replace the SERVOPACK.
A.510: Overspeed (The servomotor speed exceeds the maximum.)	The order of phases U, V, and W in the servomotor wiring is incorrect.	Check the motor wiring.	Confirm that the servomotor is correctly wired.
	A reference value exceeding the overspeed detection level was input.	Check the input value.	Reduce the reference value or adjust the gain.
	The motor speed exceeded the maximum.	Check the motor speed waveform.	Reduce the speed reference input gain, adjust the servo gain, or reconsider the operating conditions.
	A SERVOPACK fault occurred.	–	The SERVOPACK may be faulty. Replace the SERVOPACK.
A.511: Overspeed of Encoder Output Pulse Rate	The encoder output pulse frequency exceeded the limit.	Check the encoder output pulse setting.	Decrease the setting of the encoder output resolution (Pn281).
	The encoder output pulse output frequency exceeded the limit because the motor speed was too high.	Check the encoder output pulse output setting and motor speed.	Decrease the motor speed.
A.520: Vibration Alarm	Abnormal vibration was detected at the motor speed.	Check for abnormal noise from the servomotor, and check the speed and force waveforms during operation.	Reduce the motor speed or reduce the speed loop gain (Pn100).
	The mass ratio (Pn103) value is greater than the actual value or is greatly changed.	Check the mass ratio.	Set the mass ratio (Pn103) to an appropriate value.
A.521: Autotuning Alarm (Vibration was detected while executing the one-parameter tuning, EasyFFT, or tuning-less function.)	The servomotor vibrated considerably while performing tuning-less function.	Check the motor speed waveform.	Reduce the load so that the mass ratio falls within the allowable value, or raise the load level using the tuning-less levels setting (Fn200) or reduce the rigidity level.
	The servomotor vibrated considerably during one-parameter tuning or EasyFFT.	Check the motor speed waveform.	Check the operation procedure of corresponding function and take a corrective action.

(cont'd)

Alarm Number: Alarm Name	Cause	Investigative Actions	Corrective Actions
A.550: Maximum Speed Setting Error	The Pn385 setting is greater than the maximum speed.	Check the value of Pn385 and Un010 (Monitor for allowable motor maximum speed and encoder output resolution).	Set Pn385 to a value equal to or lower than the motor maximum speed.
A.710: Overload (High Load) A.720: Overload (Low Load)	Incorrect wiring or contact fault of servomotor and linear scale.	Check the wiring.	Confirm that the servomotor and linear scale are correctly wired.
	Operation beyond the overload protection characteristics.	Check the servomotor overload characteristics and executed run command.	Reconsider the load conditions and operating conditions. Or, increase the motor capacity.
	Excessive load was applied during operation because the servomotor was not driven due to mechanical problems.	Check the executed operation reference and motor speed.	Remove the mechanical problems.
	The setting of the linear scale pitch (Pn282) is incorrect.	Check the setting of Pn282.	Correct the setting of Pn282.
	The setting of the motor phase selection (Pn080.1) is incorrect.	Check the setting of Pn080.1.	Correct the setting of Pn080.1.
	A SERVOPACK fault occurred.	–	The SERVOPACK may be faulty. Replace the SERVOPACK.
A.730: A.731: Dynamic Brake Overload (An excessive power consumption of dynamic brake was detected.)	The servomotor moves because of external force.	Check the operation status.	Take measures to ensure the servomotor will not move because of external force.
	The moving energy at a DB stop exceeds the DB resistance capacity.	Check the power consumed by DB resistance (Un00B) to see how many times the DB has been used.	Reconsider the following: <ul style="list-style-type: none"> <li>• Reduce the motor reference speed.</li> <li>• Reduce the mass ratio.</li> <li>• Reduce the number of times of the DB stop operation.</li> </ul>
	A SERVOPACK fault occurred.	–	The SERVOPACK may be faulty. Replace the SERVOPACK.
A.740: Overload of Surge Current Limit Resistor (The main circuit power is turned ON/OFF too frequently.)	The inrush current limit resistor operation frequency at the main circuit power supply ON/OFF operation exceeds the allowable range.	–	Reduce the frequency of turning the main circuit power supply ON/OFF.
	A SERVOPACK fault occurred.	–	The SERVOPACK may be faulty. Replace the SERVOPACK.
A.7A0: Heat Sink Overheated (Detected when the heat sink temperature exceeds 100°C.)	The surrounding air temperature is too high.	Check the surrounding air temperature using a thermostat.	Decrease the surrounding air temperature by improving the SERVOPACK installation conditions.
	The overload alarm has been reset by turning OFF the power too many times.	Check the alarm history display (Fn000) to see if the overload alarm was reported.	Change the method for resetting the alarm.
	Excessive load or operation beyond the regenerative energy processing capacity.	Check the accumulated load ratio (Un009) to see the load during operation, and the regenerative load ratio (Un00A) to see the regenerative energy processing capacity.	Reconsider the load and operating conditions.
	Incorrect SERVOPACK installation orientation or/and insufficient space around the SERVOPACK.	Check the SERVOPACK installation conditions.	Install the SERVOPACK correctly as specified.
	A SERVOPACK fault occurred.	–	The SERVOPACK may be faulty. Replace the SERVOPACK.
A.7Ab: Built-in Fan in SERVOPACK Stopped	The fan inside the SERVOPACK stopped.	Check for foreign matter or debris inside the SERVOPACK.	Remove foreign matter or debris from the SERVOPACK. If the alarm still occurs, the SERVOPACK may be faulty. Replace the SERVOPACK.

(cont'd)

Alarm Number: Alarm Name	Cause	Investigative Actions	Corrective Actions
A.820: Encoder Checksum Error (Detected on the linear scale side.)	A linear scale fault occurred.	–	The linear scale may be faulty. Replace the linear scale.
	A SERVOPACK fault occurred.	–	The SERVOPACK may be faulty. Replace the SERVOPACK.
A.840: Encoder Data Error (Detected on the linear scale side.)	A linear scale malfunctioned.	–	Turn the power supply to the SER- VOPACK OFF and ON again. If the alarm still occurs, the linear scale may be faulty. Replace the linear scale.
	Misreading of the linear scale occurred.	–	Reinstall the linear scale, so the tol- erance is within the allowable range.
	The speed of the linear scale exceeded the allowable range.	–	Set the motor speed within the range specified by the linear scale manufacturer and restart the control power supply.
	Malfunction of linear scale because of noise interference, etc.	–	Correct the wiring around the linear scale by separating the linear scale connection cable from the servomo- tor main circuit cable or by check- ing the grounding and other wiring.
	The hall sensor wiring is incor- rect.	Check the hall sensor wiring.	Correct the hall sensor wiring.
	A hall sensor fault occurred.	–	Replace the hall sensor.
A.850: Encoder Overspeed (Detected when the con- trol power supply was turned ON.) (Detected on the linear scale side.)	The servomotor speed is higher than the specified speed when the control power supply was turned ON.	Check the motor moving speed (Un000) to confirm the servomotor speed when the power is turned ON.	Set the motor speed within the range specified by the linear scale manufacturer and restart the control power supply.
	A linear scale fault occurred.	–	Turn the power supply to the SER- VOPACK OFF and ON again. If the alarm still occurs, the linear scale may be faulty. Replace the linear scale.
	A SERVOPACK fault occurred.	–	Turn the power supply to the SER- VOPACK OFF and ON again. If the alarm still occurs, the SERVO- PACK may be faulty. Replace the SERVOPACK.
A.860: Encoder Overheated (Only when an absolute linear scale is con- nected.) (Detected on the linear scale side.)	The ambient operating tempera- ture around the servomotor is too high.	Measure the ambient operating tem- perature around the servomotor.	Reduce the ambient operating tem- perature of the servomotor to 40°C or less.
	The motor load is greater than the rated load.	Check the accumulated load ratio (Un009) to see the load.	Operate the SERVOPACK so that the motor load remains within the specified range.
	A linear scale fault occurred.	–	Turn the power supply to the SER- VOPACK OFF and ON again. If the alarm still occurs, the linear scale may be faulty. Replace the linear scale.
	A SERVOPACK fault occurred.	–	Turn the power supply to the SER- VOPACK OFF and ON again. If the alarm still occurs, the SERVO- PACK may be faulty. Replace the SERVOPACK.

(cont'd)

Alarm Number: Alarm Name	Cause	Investigative Actions	Corrective Actions
A.861: Motor Overheated	The ambient operating temperature around the servomotor is too high.	Measure the ambient operating temperature around the servomotor.	Reduce the ambient operating temperature of the servomotor to 40° or less.
	The motor load is greater than the rated load.	Check the accumulated load ratio (Un009) to see the load.	Operate the SERVOPACK so that the motor load remains within the specified range.
	A serial converter unit fault occurred.	—	Turn the power supply OFF and then ON again. If the alarm still occurs, the serial converter unit may be faulty. Replace the serial converter unit.
	A SERVOPACK fault occurred.	—	Turn the power supply OFF and then ON again. If the alarm still occurs, the SERVOPACK may be faulty. Replace the SERVOPACK.
A.890: Encoder Scale Error	A linear scale fault occurred.	—	The linear scale may be faulty. Replace the linear scale.
A.891: Encoder Module Error	A linear scale fault occurred.	—	Turn the power supply to the SERVOPACK OFF and ON again. If the alarm still occurs, the linear scale may be faulty. Replace the linear scale cable.
A.b31: Current Detection Error 1	The current detection circuit for phase U is faulty.	—	Turn the power supply to the SERVOPACK OFF and ON again. If the alarm still occurs, the SERVOPACK may be faulty. Replace the SERVOPACK.
A.b32: Current Detection Error 2	The current detection circuit for phase V is faulty.	—	Turn the power supply to the SERVOPACK OFF and ON again. If the alarm still occurs, the SERVOPACK may be faulty. Replace the SERVOPACK.
A.b33: Current Detection Error 3	The detection circuit for the current is faulty.	—	Turn the power supply to the SERVOPACK OFF and ON again. If the alarm still occurs, the SERVOPACK may be faulty. Replace the SERVOPACK.
	The servomotor main circuit cable is disconnected.	Check for disconnection of the servomotor main circuit cable.	Correct the servomotor wiring.
A.bE0: Firmware Error	A SERVOPACK fault occurred.	—	Turn the power supply OFF and then ON again. If the alarm still occurs, the SERVOPACK may be faulty. Replace the SERVOPACK.
A.bF0: System Alarm 0	A SERVOPACK fault occurred.	—	Turn the power supply to the SERVOPACK OFF and ON again. If the alarm still occurs, the SERVOPACK may be faulty. Replace the SERVOPACK.
A.bF1: System Alarm 1	A SERVOPACK fault occurred.	—	Turn the power supply to the SERVOPACK OFF and ON again. If the alarm still occurs, the SERVOPACK may be faulty. Replace the SERVOPACK.
A.bF2: System Alarm 2	A SERVOPACK fault occurred.	—	Turn the power supply to the SERVOPACK OFF and ON again. If the alarm still occurs, the SERVOPACK may be faulty. Replace the SERVOPACK.

(cont'd)

Alarm Number: Alarm Name	Cause	Investigative Actions	Corrective Actions
A.bF3: System Alarm 3	A SERVOPACK fault occurred.	–	Turn the power supply to the SERVOPACK OFF and ON again. If the alarm still occurs, the SERVOPACK may be faulty. Replace the SERVOPACK.
A.bF4: System Alarm 4	A SERVOPACK fault occurred.	–	Turn the power supply to the SERVOPACK OFF and ON again. If the alarm still occurs, the SERVOPACK may be faulty. Replace the SERVOPACK.
A.C10: Servo Overrun Detected (Detected when the servomotor power is ON.)	The order of phases U, V, and W in the servomotor wiring is incorrect.	Check the motor wiring.	Confirm that the servomotor is correctly wired.
	The setting of the motor phase selection (Pn080.1) is incorrect.	Check the setting of Pn080.1.	Correct the setting of Pn080.1.
	A linear scale fault occurred.	–	If the alarm still occurs after turning the power OFF and then ON again, even though the linear scale is correctly wired, the linear scale may be faulty. Replace the linear scale.
	A SERVOPACK fault occurred.	–	Turn the power supply to the SERVOPACK OFF and ON again. If the alarm still occurs, the SERVOPACK may be faulty. Replace the SERVOPACK.
A.C20: Phase Detection Error	The linear scale signal is weak.	Check the voltage of the linear scale signal.	Fine-adjust the installation status of the linear scale head, or replace the linear scale.
	The count-up direction of the linear scale does not match the forward direction of the motor coil assembly.	Check the setting of Pn080.1 (Motor Phase Selection). Check the installation directions for the linear scale and motor coil assembly.	Change the setting of Pn080.1 (Motor Phase Selection). Correctly reinstall the linear scale and motor coil assembly.
	The hall sensor signal is affected by noise.	–	Correct the FG wiring and take measures against noise for the hall sensor wiring.
	The setting of the linear scale pitch (Pn282) is incorrect.	Check the setting of the linear scale pitch (Pn282).	Check the specifications of the linear scale and correct the value of Pn282.
A.C21: Hall Sensor Error	The hall sensor is protruding from the motor magnetic way.	Check the hall sensor.	Correctly reinstall the motor coil assembly or motor magnetic way.
	The hall sensor wiring is incorrect.	Check the hall sensor wiring.	Correct the hall sensor wiring.
	A hall sensor fault occurred.	–	Replace the hall sensor.
A.C22: Phase Information Disagreement	The SERVOPACK phase data does not match that of the linear scale.	–	Execute polarity detection (Fn080).

(cont'd)

Alarm Number: Alarm Name	Cause	Investigative Actions	Corrective Actions
A.C50: Polarity Detection Error	Parameter settings are incorrect.	Check the linear scale specifications and feedback signal status.	The settings of the linear scale pitch (Pn282) and motor phase selection (Pn080.1) may not match the actual product requirements. Set these parameters to the correct values.
	Noise interference occurred on the scale signal.	Check the wiring to see if: <ul style="list-style-type: none"> <li>• Each FG of the serial converter unit and servomotor is connected to the FG of the SERVOPACK.</li> <li>• The FG of the SERVOPACK is connected to the FG of the power supply.</li> <li>• The linear scale connection cables are securely shielded.</li> </ul> Check to see if the detection reference is repeatedly output in one direction.	Take measures to avoid noise interference by correctly connecting FG lines, shielding the linear scale connection cables, etc.
	An external force was applied to the motor coil assembly.	—	The polarity cannot be properly detected if the detection reference is 0 (zero), but the speed feedback is not 0 (zero) because of an external force, such as cable tension, applied to the motor coil assembly. Take measures to reduce the external force so that the speed feedback becomes 0 for a 0 detection reference. If external force cannot be reduced, increase the value of the changes in the sequence input signal allocation for each signal (Pn481).
	The linear scale resolution is too low.	Check the linear scale pitch to see if it is within 100 $\mu\text{m}$ .	If the linear scale pitch is 100 $\mu\text{m}$ or longer, the SERVOPACK cannot detect the correct speed feedback. Use a scale pitch with higher accuracy (a pitch within 40 $\mu\text{m}$ recommended.) Or, increase the value of the polarity detection reference speed (Pn485). However, note that increasing the value of Pn485 will widen the servomotor movement range required for polarity detection.
A.C51: Overtravel Detection at Polarity Detection	An overtravel signal was detected during polarity detection.	Check the position after overtravel.	Perform the wiring for an overtravel signal. Execute polarity detection at a position where an overtravel signal is not detected.
A.C52: Polarity Detection Uncompleted	The servomotor has been turned ON under the following circumstances. <ul style="list-style-type: none"> <li>• An absolute linear scale is being used.</li> <li>• The polarity detection selection for the absolute linear scale was set to not execute. (Pn587.0 = 0)</li> <li>• Polarity was not yet detected.</li> </ul>	—	When using an absolute linear scale, set the parameter Pn587.0 to 1 to execute polarity detection.
A.C53: Out of Range for Polarity Detection	The moving distance exceeded the set value of Pn48E in the middle of detection.	—	Increase the value of the polarity detection range (Pn48E). Or, increase the value of the changes in the sequence input signal allocation for each signal (Pn481).

(cont'd)

Alarm Number: Alarm Name	Cause	Investigative Actions	Corrective Actions
A.C54: Polarity Detection Error 2	External force was applied to the servomotor.	–	Increase the value of the polarity detection confirmation force reference (Pn495). Increase the value of the polarity detection allowable error range (Pn498). Note that increasing the allowable error will also increase the motor temperature.
A.C80: Absolute Encoder Clear Error	A linear scale fault occurred.	–	Turn the power supply to the SERVOPACK OFF and ON again. If the alarm still occurs, the linear scale may be faulty. Replace the linear scale.
	A SERVOPACK fault occurred.	–	Turn the power supply to the SERVOPACK OFF and ON again. If the alarm still occurs, the SERVOPACK may be faulty. Replace the SERVOPACK.
A.C90: Encoder Communications Error	Contact fault of connector or incorrect wiring for linear scale connection cables.	Check the connector contact status for linear scale connection cables.	Re-insert the connectors and confirm that the linear scale is correctly wired.
	Cable disconnection for linear scale connection cables or short-circuit. Or, incorrect cable impedance.	Check the linear scale connection cables.	Use the cables with the specified rating.
	Corrosion caused by improper temperature, humidity, or gas, short-circuit caused by intrusion of water drops or cutting oil, or connector contact fault caused by vibration.	Check the operating environment.	Improve the operating environmental conditions, and replace the cable. If the alarm still occurs, replace the SERVOPACK.
	Malfunction caused by noise interference.	–	Correct the wiring around the linear scale by separating the linear scale connection cables from the servomotor main circuit cable or by checking the grounding and other wiring.
	A SERVOPACK fault occurred.	–	Connect the servomotor to another SERVOPACK, and turn ON the control power. If no alarm occurs, the SERVOPACK may be faulty. Replace the SERVOPACK.
A.C91: Encoder Communications Position Data Error	Noise interference occurred on the I/O signal line because the linear scale connection cables are bent and the sheaths are damaged.	Check the linear scale connection cables and connectors.	Confirm that there is no problem with the cable layout.
	The linear scale connection cables are bundled with a high-current line or near a high-current line.	Check the cable layout for linear scale connection cables.	Confirm that there is no surge voltage on the cables.
	The FG potential varies because of influence from machines on the servomotor side, such as the welder.	Check the cable layout for linear scale connection cables.	Properly ground the machines to separate from the linear scale FG.

(cont'd)

Alarm Number: Alarm Name	Cause	Investigative Actions	Corrective Actions
A.C92: Encoder Communications Timer Error	Noise interference occurred on the I/O signal line from the linear scale.	–	Take countermeasures against noise for the linear scale wiring.
	Excessive vibration and shocks were applied to the linear scale.	Check the operating environment.	Reduce the machine vibration or correctly install the linear scale.
	A linear scale fault occurred.	–	Turn the power supply to the SERVOPACK OFF and ON again. If the alarm still occurs, the linear scale may be faulty. Replace the linear scale.
	A SERVOPACK fault occurred.	–	Turn the power supply to the SERVOPACK OFF and ON again. If the alarm still occurs, the SERVOPACK may be faulty. Replace the SERVOPACK.
A.CA0: Encoder Parameter Error	A linear scale fault occurred.	–	Turn the power supply to the SERVOPACK OFF and ON again. If the alarm still occurs, the linear scale may be faulty. Replace the linear scale.
	A SERVOPACK fault occurred.	–	Turn the power supply to the SERVOPACK OFF and ON again. If the alarm still occurs, the SERVOPACK may be faulty. Replace the SERVOPACK.
A.Cb0: Encoder Echoback Error	The wiring and contact for linear scale connection cables are incorrect.	Check the wiring.	Correct the wiring.
	Noise interference occurred due to incorrect cable specifications of linear scale connection cables.	–	Use tinned annealed copper shielded twisted-pair or screened unshielded twisted-pair cable with a core of at least 0.12 mm <sup>2</sup> .
	Noise interference occurred because the wiring distance for the linear scale connection cables are too long.	–	The wiring distance must be 20 m max.
	The FG potential varies because of influence from machines on the servomotor side, such as the welder.	Check the cable layout for linear scale connection cables.	Properly ground the machines to separate from linear scale FG.
	Excessive vibration and shocks were applied to the linear scale.	Check the operating environment.	Reduce the machine vibration or correctly install the linear scale.
	A linear scale fault occurred.	–	Turn the power supply to the SERVOPACK OFF and ON again. If the alarm still occurs, the linear scale may be faulty. Replace the linear scale.
	A SERVOPACK fault occurred.	–	Turn the power supply to the SERVOPACK OFF and ON again. If the alarm still occurs, the SERVOPACK may be faulty. Replace the SERVOPACK.

(cont'd)

Alarm Number: Alarm Name	Cause	Investigative Actions	Corrective Actions
A.CF1: Feedback Option Module Communications Error (Reception error)	Wiring of cable between serial converter unit and SERVOPACK is incorrect or contact is faulty.	Check the linear scale wiring.	Correct the cable wiring between serial converter unit and SERVOPACK.
	The specified cable is not used between serial converter unit and SERVOPACK.	Confirm the linear scale wiring specifications.	Use the specified cable.
	Cable between serial converter unit and SERVOPACK is too long.	Measure the length of the cable for connecting the serial converter unit.	The cable between serial converter unit and SERVOPACK must be 20 m max.
	Sheath of cable between serial converter unit and SERVOPACK is broken.	Check the cable for connecting the serial converter unit.	Replace the cable.
A.CF2: Feedback Option Module Communications Error (Timer stop)	Noise interferes with the cable between serial converter unit and SERVOPACK.	—	Correct the wiring around serial converter unit, e.g., separating input/output signal line from main circuit cable or grounding.
	A serial converter unit fault occurred.	—	Replace the serial converter unit.
	A SERVOPACK fault occurred.	—	Replace the SERVOPACK.
A.d00: Position Error Overflow (Position error exceeded the value set in the excessive position error alarm level (Pn520).)	The servomotor U, V, and W wirings is faulty.	Check the servomotor main circuit cable connection.	Confirm that there is no contact fault in the motor wiring or linear scale wiring.
	The position reference speed is too high.	Reduce the reference speed, and operate the SERVOPACK.	Reduce the position reference speed or acceleration of position reference. Or, reconsider the electronic gear ratio.
	The acceleration of the position reference is too high.	Reduce the reference acceleration, and operate the SERVOPACK.	Reduce the acceleration rate of the position reference.
	Setting of the excessive position error alarm level (Pn520) is low against the operating condition.	Check the alarm level (Pn520) to see if it is set to an appropriate value.	Set the Pn520 to proper value.
	A SERVOPACK fault occurred.	—	Turn the power supply to the SERVOPACK OFF and ON again. If the alarm still occurs, the SERVOPACK may be faulty. Replace the SERVOPACK.
A.d01: Position Error Overflow Alarm at Servo ON	This alarm occurs if the servomotor power is turned ON when the position error is greater than the set value of Pn526 while the servomotor power is OFF.	Check the position error amount (Un008) while the servomotor power is OFF.	Correct the excessive position error alarm level at servo ON (Pn526).
A.d02: Position Error Overflow Alarm by Speed Limit at Servo ON	When the position errors remain in the error counter, Pn584 limits the speed if the servomotor power is ON. If Pn584 limits the speed in such a state, this alarm occurs when position references are input and the number of position errors exceeds the value set for the excessive position error alarm level (Pn520).	—	Correct the excessive position error alarm level (Pn520). Or, adjust the speed limit level at servo ON (Pn584).
A.d30: Position Data Overflow	The position data exceeded $\pm 1879048192$ .	Check the input reference pulse counter (Un00C).	Reconsider the operating specifications.

(cont'd)

Alarm Number: Alarm Name	Cause	Investigative Actions	Corrective Actions
A.E00: Command Option Module IF Initialization Timeout Error	The connection between the SERVOPACK and the command option module is faulty.	Check the connection between the SERVOPACK and the command option module.	Correctly connect the command option module.
	A command option module fault occurred.	—	Replace the command option module.
	A SERVOPACK fault occurred.	—	Replace the SERVOPACK.
A.E02: Command Option Module IF Synchronization Error 1	The timing of synchronization between the SERVOPACK and command option module changed due to change in the communications cycle of the host controller connected to the command option module.	—	Turn the power supply OFF and then ON again. If the alarm occurs again, restart communications processing from the host controller.
	The connection between the SERVOPACK and the command option module is faulty.	Check the connection between the SERVOPACK and the command option module.	Correctly connect the command option module.
	A command option module fault occurred.	—	Replace the command option module.
	A SERVOPACK fault occurred.	—	Replace the SERVOPACK.
A.E03: Command Option Module IF Communications Data Error	An error occurred due to noise in the communications between the SERVOPACK and the command option module.	—	Take measures against noise.
	The connection between the SERVOPACK and the command option module is faulty.	Check the connection between the SERVOPACK and the command option module.	Correctly connect the command option module.
	A command option module fault occurred.	—	Replace the command option module.
	A SERVOPACK fault occurred.	—	Replace the SERVOPACK.
A.E40: Command Option Module IF Communications Setting Error	A command option module fault occurred.	—	Replace the command option module.
A.E50: Command Option Module IF Synchronization Error 2	The timing of synchronization between the SERVOPACK and command option module changed due to change in the communications cycle of the host controller connected to the command option module.	—	Turn the power supply OFF and then ON again. If the alarm occurs again, restart communications processing from the host controller.
A.E51: Command Option Module IF Synchronization Establishment Error	A command option module fault occurred.	—	Replace the command option module.

(cont'd)

Alarm Number: Alarm Name	Cause	Investigative Actions	Corrective Actions
A.E60: Command Option Module IF Data Communications Error	An error occurred due to noise in the communications between the SERVOPACK and the command option module.	—	Take measures against noise.
	The connection between the SERVOPACK and the command option module is faulty.	Check the connection between the SERVOPACK and the command option module.	Correctly connect the command option module.
	A command option module fault occurred.	—	Replace the command option module.
	A SERVOPACK fault occurred.	—	Replace the SERVOPACK.
A.E61: Command Option Module IF Synchronization Error 3	The timing of synchronization between the SERVOPACK and command option module changed due to change in the communications cycle of the host controller connected to the command option module.	—	Turn the power supply OFF and then ON again. If the alarm occurs again, restart communications processing from the host controller.
	The connection between the SERVOPACK and the command option module is faulty.	Check the connection between the SERVOPACK and the command option module.	Correctly connect the command option module.
	A command option module fault occurred.	—	Replace the command option module.
	A SERVOPACK fault occurred.	—	Replace the SERVOPACK.
A.E70: Command Option Module Detection Failure	The connection between the SERVOPACK and the command option module is faulty.	Check the connection between the SERVOPACK and the command option module.	Correctly connect the command option module.
	The command option module is not connected.	—	Correctly connect the command option module.
	A command option module fault occurred.	—	Replace the command option module.
	A SERVOPACK fault occurred.	—	Replace the SERVOPACK.
A.E71: Safety Option Module Detection Failure	The connection between the SERVOPACK and the safety option module is faulty.	Check the connection between the SERVOPACK and the safety option module.	Correctly connect the safety option module.
	The safety option module was disconnected.	—	Execute Fn014 (Resetting configuration error in option module) from the digital operator or SigmaWin+, and then turn the power supply OFF and ON again.
	A safety option module fault occurred.	—	Replace the safety option module.
	A SERVOPACK fault occurred.	—	Replace the SERVOPACK.
A.E72: Feedback Option Module Detection Failure	The connection between the SERVOPACK and the feedback option module is faulty.	Check the connection between the SERVOPACK and the feedback option module.	Correctly connect the feedback option module.
	The feedback option module was disconnected.	—	Execute Fn014 (Resetting configuration error in option module) from the digital operator or SigmaWin+, and then turn the power supply OFF and ON again.
	A feedback option module fault occurred.	—	Replace the feedback option module.
	A SERVOPACK fault occurred.	—	Replace the SERVOPACK.

(cont'd)

Alarm Number: Alarm Name	Cause	Investigative Actions	Corrective Actions
A.E73: Unsupported Option Module	A command option module fault occurred.	–	Replace the command option module.
	A unsupported command option module was connected.	Refer to the catalog of the connected command option module.	Connect a compatible command option module.
A.E74: Unsupported Safety Option Module	A safety option module fault occurred.	–	Replace the safety option module.
	A unsupported safety option module was connected.	Refer to the catalog of the connected safety option module.	Connect a compatible safety option module.
A.E75: Unsupported Feedback Option Module	A feedback option module fault occurred.	–	Replace the feedback option module.
	A unsupported feedback option module was connected.	Refer to the catalog of the connected feedback option module or the manual of the SERVOPACK.	Connect a compatible feedback option module.
A.E80: Command Option Module Unmatched Error	The command option module was replaced with a different model.	–	Execute Fn014 (Resetting configuration error in option module) from the digital operator or SigmaWin+, and then turn the power supply OFF and ON again.
A.EA2: DRV Alarm 2 (SERVOPACK WDT error)	The timing of synchronization between the SERVOPACK and command option module changed due to change in the communications cycle of the host controller connected to the command option module.	–	Turn the power supply OFF and then ON again. If the alarm occurs again, restart communications processing from the host controller.
	The connection between the SERVOPACK and the command option module is faulty.	Check the connection between the SERVOPACK and the command option module.	Correctly connect the command option module.
	A command option module fault occurred.	–	Replace the command option module.
	A SERVOPACK fault occurred.	–	Turn the power supply to the SERVOPACK OFF and ON again. If the alarm still occurs, the SERVOPACK may be faulty. Replace the SERVOPACK.
A.Eb1: Safety Function Signal Input Timing Error	The lag between activations of the input signals /HWBB1 and /HWBB2 for the HWBB function is ten second or more.	Measure the time lag between the /HWBB1 and /HWBB2 signals.	The output signal circuits or devices for /HWBB1 and /HWBB2 or the SERVOPACK input signal circuits may be faulty. Alternatively, the input signal cables may be disconnected. Check if any of these items are faulty or have been disconnected.
A.Ed1: Command Option Module IF Command Timeout Error	Processing of the sensor ON command from the command option module is not completed.	–	Input a servo ON command when the linear servomotor is stopped.
	Processing of the sensor ON command from the command option module is not completed.	–	Check that the linear scale is connected correctly and input a sensor ON command when the linear servomotor is stopped.

(cont'd)

Alarm Number: Alarm Name	Cause	Investigative Actions	Corrective Actions
A.F10: Main Circuit Cable Open Phase (A low voltage continued for one second or longer in either phase R, S, or T when the main circuit power supply was ON.) (Detected when the main circuit power supply is turned ON.)	The three-phase power supply wiring is incorrect.	Check the power supply wiring.	Confirm that the power supply is correctly wired.
	The three-phase power supply is unbalanced.	Measure the voltage at each phase of the three-phase power supply.	Balance the power supply by changing phases.
	A single-phase power is input without setting Pn00B.2 (power supply method for three-phase SERVOPACK) to 1 (single-phase power supply).	Check the power supply and the parameter setting.	Match the parameter setting to the power supply.
	A SERVOPACK fault occurred.	—	Turn the power supply to the SERVOPACK OFF and ON again. If the alarm still occurs, the SERVOPACK may be faulty. Replace the SERVOPACK.
A.F50: Servomotor Main Circuit Cable Disconnection (The servomotor did not operate or power was not supplied to the servomotor even though the servo ON command was input when the servomotor was ready to receive it.)	A SERVOPACK fault occurred.	—	The SERVOPACK may be faulty. Replace the SERVOPACK.
	The wiring is not correct or there is a faulty contact in the motor wiring.	Check the wiring.	Make sure that the servomotor is correctly wired.
FL-1*3: System Alarm	SERVOPACK failure	—	Turn the power supply to the SERVOPACK OFF and ON again. If the alarm still occurs, the SERVOPACK may be faulty. Replace the SERVOPACK.
FL-2*3: System Alarm			
CPF00: Digital Operator Transmission Error 1	The contact between the digital operator and the SERVOPACK is faulty.	Check the connector contact.	Insert securely the connector or replace the cable.
	Malfunction caused by noise interference.	—	Keep the digital operator or the cable away from noise sources.
CPF01: Digital Operator Transmission Error 2	A digital operator fault occurred.	—	Disconnect the digital operator and then re-connect it. If the alarm still occurs, the digital operator may be faulty. Replace the digital operator.
	A SERVOPACK fault occurred.	—	Turn the power supply to the SERVOPACK OFF and ON again. If the alarm still occurs, the SERVOPACK may be faulty. Replace the SERVOPACK.

## \*1. Detection conditions

If one of the following conditions is detected, an alarm occurs.

$$\bullet \frac{\text{Pn585}[\text{mm/s}]}{\text{Linear scale pitch} [\mu\text{m}]} \times \frac{\text{Number of divisions of serial converter unit}}{10} \leq \frac{\text{Pn20E}}{\text{Pn210}}$$

$$\bullet \frac{\text{Pn385} [100 \text{ mm/s}]}{\text{Linear scale pitch} [\mu\text{m}]} \times \frac{\text{Number of divisions of serial converter unit}}{\text{About } 6.10 \times 10^5} \geq \frac{\text{Pn20E}}{\text{Pn210}}$$

## \*2. Detection conditions

If one of the following conditions is detected, an alarm occurs.

$$\bullet \frac{\text{Rated motor speed} [\text{mm/s}] \times 1/3}{\text{Linear scale pitch} [\mu\text{m}]} \times \frac{\text{Number of divisions of serial converter unit}}{10} \leq \frac{\text{Pn20E}}{\text{Pn210}}$$

$$\bullet \frac{\text{Pn385} [100 \text{ mm/s}]}{\text{Linear scale pitch} [\mu\text{m}]} \times \frac{\text{Number of divisions of serial converter unit}}{\text{About } 6.10 \times 10^5} \geq \frac{\text{Pn20E}}{\text{Pn210}}$$

## \*3. These alarms are not stored in the alarm history and are displayed only in the panel display

## 8.2 Warning Displays

The following sections describe troubleshooting in response to warning displays.

The warning name and warning meaning output are listed in order of the warning numbers in *8.2.1 List of Warnings*.

The causes of warnings and troubleshooting methods are provided in *8.2.2 Troubleshooting of Warnings*.

### 8.2.1 List of Warnings

This section provides list of warnings.

Warning Number	Warning Name	Meaning
A.900* <sup>1</sup>	Position Error Overflow	Position error exceeded the parameter setting (Pn520×Pn51E/100).
A.901* <sup>1</sup>	Position Error Overflow Alarm at Servo ON	When the servomotor power is ON, the position error exceeded the parameter setting (Pn526×Pn528/100).
A.910* <sup>1</sup>	Overload	This warning occurs before the overload alarms (A.710 or A.720) occur. If the warning is ignored and operation continues, an overload alarm may occur.
A.911* <sup>1</sup>	Vibration	Abnormal vibration at the motor speed was detected. The detection level is the same as A.520. Set whether to output an alarm or warning by the vibration detection switch (Pn310).
A.920* <sup>1</sup>	Regenerative Overload	This warning occurs before the regenerative overload alarm (A.320) occurs. If the warning is ignored and operation continues, a regenerative overload alarm may occur.
A.921* <sup>1</sup>	Dynamic Brake Overload	This warning occurs before dynamic brake overload alarm (A.731) occurs. If the warning is ignored and operation continues, a dynamic brake overload alarm may occur.
A.94A	Command Option Module IF Data Setting Warning 1	This warning occurs when there is an error in a parameter number sent to the SERVOPACK from the host controller or command option module.
A.94B	Command Option Module IF Data Setting Warning 2	This warning occurs when out-of-range data is sent to the SERVOPACK from the host controller or command option module.
A.94C	Command Option Module IF Data Setting Warning 3	This warning occurs when there is an error in the parameter data sent to in the SERVOPACK from the host controller or command option module.
A.94D	Command Option Module IF Data Setting Warning 4	This warning occurs when there is an error in the data size sent to the SERVOPACK from the host controller or command option module.
A.94E	Command Option Module IF Data Setting Warning 5	This warning occurs when there is an error in the latch mode settings sent to the SERVOPACK from the host controller or command option module.
A.95A	Command Option Module IF Command Warning 1	This warning occurs when the host controller or command option module outputs an operating command when the operation execution conditions in the SERVOPACK have not been met.
A.95B	Command Option Module IF Command Warning 2	This warning occurs when there is an error in the reference output from the command option module to the SERVOPACK.
A.95D	Command Option Module IF Command Warning 4	This warning occurs when a latch command is output from the command option module to the SERVOPACK during latch operation.
A.95E	Command Option Module IF Command Warning 5	This warning occurs when an unallowed command combination is output to the SERVOPACK from the command option module.
A.95F	Command Option Module IF Command Warning 6	This warning occurs when there is an error in the command output to the SERVOPACK from the command option module.
A.960	Command Option Module IF Communications Warning	This warning occurs when an error occurred in communications between the SERVOPACK and command option module.
A.971* <sup>2</sup>	Undervoltage	This warning occurs before undervoltage alarm (A.410) occurs. If the warning is ignored and operation continues, an undervoltage alarm may occur.
A.9A0* <sup>1</sup>	Overtravel	Overtravel is detected while the servomotor power is ON.

\*1. Use Pn008.2 to activate or not the warning detection.

\*2. Use Pn008.1 to activate or not the warning detection.

## 8.2.2 Troubleshooting of Warnings

Refer to the following table to identify the cause of a warning and the action to be taken. Contact your Yaskawa representative if the problem cannot be solved by the described corrective action.

Warning Number: Warning Name	Cause	Investigative Actions	Corrective Actions
A.900: Position Error Overflow	The servomotor U, V, and W wirings is faulty.	Check the servomotor main circuit cable connection.	Confirm that there is no contact fault in the motor wiring or linear scale wiring.
	The SERVOPACK gain is too low.	Check the SERVOPACK gain.	Increase the servo gain by using the function such as advanced autotuning.
	The acceleration of the position reference is too high.	Reduce the reference acceleration, and operate the SERVOPACK.	Reduce the acceleration rate of the position reference.
	Setting of the excessive position error alarm level (Pn520) is low against the operating condition.	Check the alarm level (Pn520) to see if it is set to an appropriate value.	Set the Pn520 to proper value.
	A SERVOPACK fault occurred.	—	Turn the power supply to the SERVOPACK OFF and ON again. If the alarm still occurs, the SERVOPACK may be faulty. Replace the SERVOPACK.
A.901: Position Error Overflow Alarm at Servo ON	When the servomotor power is ON, the position error exceeded the parameter setting (Pn526×Pn528/100).	—	Set an appropriate value for the excessive position error warning level at servo ON (Pn528).
A.910: Overload (Warning before the overload alarm (A.710 or A.720).)	Incorrect wiring or contact fault of servomotor and linear scale.	Check the wiring.	Confirm that the servomotor and linear scale are correctly wired.
	Operation beyond the overload protection characteristics.	Check the motor overload characteristics and executed run command.	Reconsider the load conditions and operating conditions. Or, increase the motor capacity.
	Excessive load was applied during operation because the servomotor was not driven due to mechanical problems.	Check the executed operation reference and motor speed.	Remove the mechanical problems.
	A SERVOPACK fault occurred.	—	The SERVOPACK may be faulty. Replace the SERVOPACK.
A.911: Vibration	Abnormal vibration was detected at the motor speed.	Check for abnormal noise from the servomotor, and check the speed and force waveforms during operation.	Reduce the motor speed or reduce the servo gain by using the function such as one-parameter tuning.
	The mass ratio (Pn103) value is greater than the actual value or is greatly changed.	Check the mass ratio.	Set the mass ratio (Pn103) to an appropriate value.

(cont'd)

Warning Number: Warning Name	Cause	Investigative Actions	Corrective Actions
A.920: Regenerative Overload (Warning before the alarm A.320 occurs)	The power supply voltage exceeds the specified limit.	Measure the power supply voltage.	Set the power supply voltage within the specified range.
	Insufficient external regenerative resistance, regenerative resistor capacity, or SERVOPACK capacity. Or, regenerative power has been continuously flowing back.	Check the operating condition or the capacity using the capacity selection Software SigmaJunmaSize+, etc.	Change the regenerative resistance, regenerative resistor capacity, or SERVOPACK capacity. Reconsider the operating conditions using the capacity selection software SigmaJunmaSize+, etc.
	Regenerative power continuously flowed back because negative load was continuously applied.	Check the load to the servomotor during operation.	Reconsider the system including servo drives, machine, and operating conditions.
A.921: Dynamic Brake Overload (Warning before the alarm A.731 occurs)	The servomotor moves because of external force.	Check the operation status.	Take measures to ensure the servomotor will not move because of external force.
	The moving energy at a DB stop exceeds the DB resistance capacity.	Check the power consumed by DB resistance (Un00B) to see how many times the DB has been used.	Reconsider the following: <ul style="list-style-type: none"> <li>• Reduce the motor reference speed.</li> <li>• Reduce the mass ratio.</li> <li>• Reduce the number of times of the DB stop operation.</li> </ul>
	A SERVOPACK fault occurred.	–	The SERVOPACK may be faulty. Replace the SERVOPACK.
A.94A: Command Option Module IF Data Setting Warning 1	An incorrect parameter number was sent to the SERVOPACK from the host controller or command option module.	–	Specify the correct parameter number.
A.94B: Command Option Module IF Data Setting Warning 2	Out-of-range data was sent to the SERVOPACK from the host controller or command option module.	–	Specify the value of the parameter within the allowable range.
A.94C: Command Option Module IF Data Setting Warning 3	Incorrect parameter data was sent to the SERVOPACK from the host controller or command option module.	–	Specify the value of the parameter within the allowable range.
A.94D: Command Option Module IF Data Setting Warning 4	The incorrect parameter size was sent to the SERVOPACK from the host controller or command option module.	–	Specify the correct parameter size.
A.94E: Command Option Module IF Data Setting Warning 5	Incorrect latch mode settings were sent to the SERVOPACK from the host controller or command option module.	–	Set a proper value for the latch mode.

(cont'd)

Warning Number: Warning Name	Cause	Investigative Actions	Corrective Actions
A.95A: Command Option Module IF Command Warning 1	The host controller or command option module sent a operating command when the operation execution conditions in the SERVOPACK had not been satisfied.	—	Send a command after the operation conditions are satisfied.
A.95B: Command Option Module IF Command Warning 2	The command option module sent a command that is not supported by the SERVOPACK.	—	Send a command that is supported by the SERVOPACK.
A.95D: Command Option Module IF Command Warning 4	A latch command was sent from the command option module during latch operation.	—	Review the input sequence for the latch command.
A.95E: Command Option Module IF Command Warning 5	An unallowed command combination was output to the SERVOPACK from the command option module.	—	Send a command that can be combined.
A.95F: Command Option Module IF Command Warning 6	The command option module sent a command that is not supported by the SERVOPACK.	—	Send a command that is supported by the SERVOPACK.
A.960: Command Option Module IF Communications Warning	An error occurred in communications between the SERVOPACK and command option module due to noise.	—	Take measures against noise.
	The connection between the SERVOPACK and the command option module is faulty.	Check the connection between the SERVOPACK and the command option module.	Correctly connect the command option module.
	A command option module fault occurred.	—	Replace the command option module.
	A SERVOPACK fault occurred.	—	The SERVOPACK may be faulty. Replace the SERVOPACK.

(cont'd)

Warning Number: Warning Name	Cause	Investigative Actions	Corrective Actions
A.971: Undervoltage	<ul style="list-style-type: none"> <li>• For 100 VAC SERVOPACKs: The AC power supply voltage is 60 V or less.</li> <li>• For 200-VAC SERVOPACKs: The AC power supply voltage is 140 V or less.</li> <li>• For 400-VAC SERVOPACKs: The AC power supply voltage is 280 V or less.</li> </ul>	Measure the power supply voltage.	Set the power supply voltage within the specified range.
	The power supply voltage dropped during operation.	Measure the power supply voltage.	Increase the power supply capacity.
	Occurrence of instantaneous power interruption.	Measure the power supply voltage.	When the instantaneous power cut hold time (Pn509) is set, decrease the setting.
	The SERVOPACK fuse is blown out.	–	Replace the SERVOPACK and connect a reactor to the SERVOPACK.
	A SERVOPACK fault occurred.	–	The SERVOPACK may be faulty. Replace the SERVOPACK.
A.9A0: Overtravel (Overtravel status is detected.)	When the servomotor power is ON, overtravel status is detected.	Check the input signal monitor (Un005) to check the status of the overtravel signals.	<p>Refer to <i>8.3 Troubleshooting Malfunction Based on Operation and Conditions of the Servomotor</i>. Even if overtravel signals were not shown by the input signal monitor (Un005), momentary overtravel may have been detected. Take the following precautions.</p> <ul style="list-style-type: none"> <li>• Do not specify movements that would cause overtravel from the host controller.</li> <li>• Check the wiring of the overtravel signals.</li> <li>• Take countermeasures for noise.</li> </ul>

### 8.3 Troubleshooting Malfunction Based on Operation and Conditions of the Servomotor

Troubleshooting for the malfunctions based on the operation and conditions of the servomotor is provided in this section.

Be sure to turn OFF the servo system before troubleshooting items shown in bold lines in the table.

Problem	Probable Cause	Investigative Actions	Corrective Actions
Servomotor Does Not Start	The control power supply is not ON.	Check voltage between control power terminals.	Correct the wiring.
	The main circuit power supply is not ON.	Check the voltage between main circuit power terminals.	Correct the wiring so that the main circuit power supply turns ON.
	Wiring of I/O signal connector CN1 is faulty or disconnected.	Check if the connector CN1 is properly inserted and connected.	Correct the connector CN1 connection.
	Wiring for servomotor main circuit cable or linear scale connection cables is disconnected.	Check the wiring.	Correct the wiring.
	Overloaded	Run under no load and check the load status.	Reduce load or replace with larger capacity servomotor.
	Linear scale type differs from parameter setting (Pn002.2).	Check the settings for parameter Pn002.2.	Set parameter Pn002.2 to the linear scale type being used.
	Settings for the input signal selections (Pn50A, Pn50B and Pn511) is incorrect.	Check the settings for parameters Pn50A, Pn50B and Pn511.	Correct the settings for parameter Pn50A, Pn50B and Pn511.
	The servo ON command has not been input.	Check the command from the host controller.	Input the servo ON command from the host controller.
	The servo ON command has not been input.	Check the command from the host controller.	Output the command to the SERVOPACK in the correct sequence.
	The forward run prohibited (P-OT) and reverse run prohibited (N-OT) input signals are turned OFF.	Check P-OT or N-OT input signal.	Turn P-OT or N-OT input signal ON.
	The safety input signal (/HWBB1 or /HWBB2) remains OFF.	Check the /HWBB1 and /HWBB2 input signal.	Set the /HWBB1 and /HWBB2 input signal to ON. When not using the safety function, mount the safety function's jumper connector (provided as an accessory) on the CN8.
	A SERVOPACK fault occurred.	—	Replace the SERVOPACK.
	The polarity detection is not executed.	Check the parameter Pn080.0.	Correct the setting of Pn080.0.
Check the servo ON command input.		<ul style="list-style-type: none"> <li>For an incremental linear scale, input the servo ON command from the host controller.</li> <li>For an absolute linear scale, execute Fn080.</li> </ul>	

(cont'd)

Problem	Probable Cause	Investigative Actions	Corrective Actions
Servomotor Moves Instantaneously, and then Stops	Servomotor wiring is incorrect.	Check the wiring.	Correct the wiring.
	Serial converter unit wiring is incorrect.	Check the wiring.	Correct the wiring.
	Linear scale wiring is incorrect.	Check the wiring.	Correct the wiring.
	Linear scale pitch (Pn282) is incorrect.	Check the setting of Pn282.	Correct the setting of Pn282.
	Linear scale counting up direction and servomotor coil assembly forward direction do not agree.	Check the directions.	Change the setting of Pn080.1 (Motor Phase Selection). Match the linear scale direction and coil assembly direction.
	Polarity detection is not performed correctly.	Check if the value of Un004 (electrical angle 2 from polarity origin) at an arbitrary position is between $\pm 10$ degrees.	Correct the settings for the polarity detection related parameter.
Servomotor Speed Unstable	Wiring connection to servomotor is defective.	Check connections of power line (phases U, V, and W) and serial converter unit connectors.	Tighten any loose terminals or connectors and correct the wiring.
Servomotor Moves Without Reference Input	A SERVOPACK fault occurred.	–	Replace the SERVOPACK.
	Linear scale counting up direction and servomotor coil assembly forward direction do not agree.	Check the directions.	Change the setting of Pn080.1 (Motor Phase Selection). Match the linear scale direction and servomotor direction.
	Polarity detection is not performed correctly.	Check if the value of Un004 (electrical angle 2 from polarity origin) at an arbitrary position is between $\pm 10$ degrees.	Correct the settings for the polarity detection related parameter.
Dynamic Brake Does Not Operate	Improper Pn001.0 setting	Check the setting for parameter Pn001.0.	Correct the setting for parameter Pn001.0.
	DB resistor disconnected	Check if excessive mass, motor overspeed, or DB frequently activated occurred.	Replace the SERVOPACK, and reduce the load.
	DB drive circuit fault	–	There is a defective component in the DB circuit. Replace the SERVOPACK.
Abnormal Noise from Servomotor	The servomotor largely vibrated during execution of tuning-less function.	Check the motor speed waveform.	Reduce the load so that the mass ratio becomes within the allowable value, or increase the load level or lower the tuning level for the tuning-less levels setting (Fn200).
	Mounting is not secured.	Check if there are any loose mounting screws.	Tighten the mounting screws.
	Vibration source at the driven machine.	Check for any foreign matter, damage, or deformations on the machinery's movable parts.	Contact the machine manufacturer.
	Noise interference due to incorrect I/O signal cable specifications.	The I/O signal cable must be tinned annealed copper shielded twisted-pair or screened unshielded twisted-pair cable with a core of 0.12 mm <sup>2</sup> min.	Use the specified I/O signal cable.
	Noise interference due to length of I/O signal cable.	Check the length of the I/O signal cable.	Make the I/O signal cable length 3 m or less.
	Noise interference due to incorrect cable specifications of linear scale connection cables.	The linear scale connection cables must be tinned annealed copper shielded twisted-pair or screened unshielded twisted-pair cable with a core of 0.12 mm <sup>2</sup> min.	Use the specified linear scale connection cables.

(cont'd)

Problem	Probable Cause	Investigative Actions	Corrective Actions
Abnormal Noise from Servomotor (cont'd)	Noise interference due to length of linear scale connection cables.	Check the length of the linear scale connection cables.	The length of each cable must be equal to or shorter than the maximum wiring length listed here. <ul style="list-style-type: none"> <li>• Connection cables for serial converter unit: 20 m</li> <li>• Connection cables for linear scale: 15 m</li> <li>• Connection cables for hall sensor: 15 m</li> </ul>
	Noise interference due to damaged linear scale connection cables.	Check if the linear scale connection cables are bent and the sheaths are damaged.	Replace the linear scale connection cables and correct the cable layout.
	Excessive noise to the linear scale connection cables.	Check if the linear scale connection cables are bundled with a high-current line or near a high-current line.	Correct the cable layout so that no surge is applied.
	The FG potential varies because of influence from machines on the servomotor side, such as the welder.	Check if the machines are correctly grounded.	Properly ground the machines to separate from the linear scale FG.
	SERVOPACK pulse counting error due to noise interference	Check if there is noise interference on the I/O signal line from the linear scale.	Take measures against noise in the linear scale wiring.
	Excessive vibration and shock to the linear scale	Check if vibration from the machine occurred or linear scale installation is incorrect (mounting surface accuracy and fixing method).	Reduce vibration from the machine, or secure the linear scale installation.
	Serial converter unit fault	–	Replace the serial converter unit.
	A linear scale fault occurred.	–	Replace the linear scale.
Servomotor Vibrates at Frequency of Approx. 200 to 400 Hz.	Unbalanced servo gains	Check to see if the servo gains have been correctly adjusted.	Execute the advanced autotuning.
	Speed loop gain value (Pn100) too high.	Check the speed loop gain (Pn100). Factory setting: $K_v = 40.0$ Hz	Reduce the speed loop gain (Pn100).
	Position loop gain value (Pn102) too high.	Check the position loop gain (Pn102). Factory setting: $K_p = 40.0/s$	Reduce the position loop gain (Pn102).
	Incorrect speed loop integral time constant (Pn101)	Check the speed loop integral time constant (Pn101). Factory setting: $T_i = 20.0$ ms	Correct the speed loop integral time constant (Pn101).
	Incorrect mass ratio (Pn103)	Check the mass ratio (Pn103).	Correct the mass ratio (Pn103).
High Motor Speed Overshoot on Starting and Stopping	Unbalanced servo gains	Check to see if the servo gains have been correctly adjusted.	Execute the advanced autotuning.
	Speed loop gain value (Pn100) too high	Check the speed loop gain (Pn100). Factory setting: $K_v = 40.0$ Hz	Reduce the speed loop gain (Pn100).
	Position loop gain value (Pn102) too high	Check the position loop gain (Pn102). Factory setting: $K_p = 40.0/s$	Reduce the position loop gain (Pn102).
	Incorrect speed loop integral time constant (Pn101)	Check the speed loop integral time constant (Pn101). Factory setting: $T_i = 20.0$ ms	Correct the speed loop integral time constant (Pn101).
	Incorrect mass ratio data (Pn103)	Check the mass ratio (Pn103).	Correct the mass ratio (Pn103).
	The force reference is saturated.	Check the force reference waveform.	Use the mode switch function.
	The force limit (Pn483, Pn484) is set to the initial value.	Initial value of force limit: Pn483 = 30% Pn484 = 30%	Set a appropriate value for Pn483 and Pn484 (Force Limit).

(cont'd)

Problem	Probable Cause	Investigative Actions	Corrective Actions
Absolute Linear Scale Position Difference Error (The position saved in the host controller when the power was turned OFF is different from the position when the power was next turned ON.)	Noise interference due to incorrect cable specifications of linear scale connection cables.	The linear scale connection cables must be tinned annealed copper shielded twisted-pair or screened unshielded twisted-pair cable with a core of 0.12 mm <sup>2</sup> min.	Use the specified linear scale connection cables.
	Noise interference due to length of linear scale connection cables.	Check the length of the linear scale connection cables.	The length of each cable must be equal to or shorter than the maximum wiring length listed here. <ul style="list-style-type: none"> <li>• Connection cables for serial converter unit: 20 m</li> <li>• Connection cables for linear scale: 15 m</li> <li>• Connection cables for hall sensor: 15 m</li> </ul>
	Noise interference due to damaged linear scale connection cables.	Check if the linear scale connection cables are bent and the sheaths are damaged.	Replace the linear scale connection cables and correct the cable layout.
	Excessive noise to the linear scale connection cables.	Check if the linear scale connection cables are bundled with a high-current line or near a high-current line.	Correct the cable layout so that no surge is applied.
	FG potential varies because of influence of machines such as welders at the servomotor.	Check if the machines are correctly grounded.	Ground machines correctly, and prevent diversion to the FG on the linear scale side.
	SERVOPACK pulse counting error due to noise interference	Check if there is noise interference on the I/O signal line from the serial converter unit.	Take measures against noise in the serial converter unit wiring.
	Excessive vibration and shock to the linear scale	Check to see if the machine is vibrating. Also, check the installation conditions of the linear scale (flange face accuracy and anchoring condition).	Reduce vibration from the machine, or secure the linear scale installation.
	A linear scale fault occurred.	–	Replace the linear scale.
	A SERVOPACK fault occurred.	–	Replace the SERVOPACK.
	Host controller serial data reading error		Check the error detection section of the host controller.
		Check if the host controller is executing data parity checks.	Perform a parity check on the serial data.
		Check noise in the cable between the SERVOPACK and the host controller.	Implement measures against noise and perform a parity check on the serial data again.

(cont'd)

Problem	Probable Cause	Investigative Actions	Corrective Actions
Overtravel (OT)	Forward or reverse run prohibited signal is input.	Check the external power supply (+24 V) voltage for the input signal.	Correct the external power supply (+24 V) voltage.
		Check if the overtravel limit switch operates properly.	Correct the overtravel limit switch.
		Check if the overtravel limit switch is wired correctly.	Correct the overtravel limit switch wiring.
		Check the settings for parameters Pn50A and Pn50B.	Correct the settings for parameters Pn50A and Pn50B.
	Forward or reverse run prohibited signal malfunctioning.	Check the fluctuation of the external power supply (+24 V) voltage for the input signal.	Stabilize the external power supply (+24 V) voltage.
		Check if the overtravel limit switch operates correctly.	Correct the overtravel limit switch.
		Check if the overtravel limit switch wiring is correct. (check for damaged cables or loose screws.)	Correct the overtravel limit switch wiring.
	Incorrect forward or reverse run prohibited signal (P-OT/N-OT) allocation (parameters Pn50A.3, Pn50B.0)	Check if the P-OT signal is allocated in Pn50A.3.	If another signal is allocated in Pn50A.3, allocate P-OT.
		Check if the N-OT signal is allocated in Pn50B.0.	If another signal is allocated in Pn50B.0, allocate N-OT.
	Incorrect servomotor stop method selection	Check the settings for parameters Pn001.0 and Pn001.1 when the servomotor power is OFF.	Select a servomotor stop method other than "coast to stop."
Check the settings for parameters Pn001.0 and Pn001.1 when in force control.		Select a servomotor stop method other than "coast to stop."	
Improper Stop Position by Overtravel (OT) Signal	Improper limit switch position and dog length	–	Install the limit switch at the appropriate position.
	The overtravel limit switch position is too short for the coasting distance.	–	Install the overtravel limit switch at the appropriate position.

(cont'd)

Problem	Probable Cause	Investigative Actions	Corrective Actions
Position Error (Without Alarm)	Noise interference due to incorrect linear scale connection cable specifications	The linear scale connection cable must be tinned annealed copper shielded twisted-pair or screened unshielded twisted-pair cable with a core of 0.12 mm <sup>2</sup> min.	Use the specified linear scale connection cable.
	Noise interference due to length of linear scale connection cables.	Check the length of the linear scale connection cables.	The length of each cable must be equal to or shorter than the maximum wiring length listed here. <ul style="list-style-type: none"> <li>• Connection cables for serial converter unit: 20 m</li> <li>• Connection cables for linear scale: 15 m</li> <li>• Connection cables for hall sensor: 15 m</li> </ul>
	Noise influence due to damaged linear scale connection cables.	Check if the linear scale connection cables are bent and the sheaths are damaged.	Replace the linear scale connection cables and modify the cable layout.
	Excessive noise to linear scale connection cables.	Check if the linear scale connection cables are bundled with a high-current line or near a high-current line.	Change the cable layout so that no surge is applied.
	The FG potential varies because of influence from machines on the servomotor side such as the welder.	Check if the machines are correctly grounded.	Properly ground the machines linear scale FG.
	SERVOPACK pulse count error due to noise	Check if the I/O signal line from the serial converter unit is influenced by noise.	Take measures against noise in the serial converter unit wiring.
	Excessive vibration and shock to the linear scale	Check if vibration from the machine occurred or linear scale installation is incorrect (mounting surface accuracy and fixing method).	Reduce the machine vibration or mount the linear scale securely.
	Noise interference due to improper I/O signal cable specifications	The I/O signal cable must be tinned annealed copper shielded twisted-pair or screened unshielded twisted-pair cable with a core of 0.12 mm <sup>2</sup> min.	Use input signal cable with the specified specifications.
	Noise interference due to length of I/O signal cable	Check the I/O signal cable length.	Make the I/O signal cable length 3 m or less.
	A linear scale fault occurred. (The pulse count does not change.)	–	Replace the linear scale.
A SERVOPACK fault occurred.	–	Replace the SERVOPACK.	
Servomotor Overheated	Ambient operating temperature too high	Measure the servomotor ambient operating temperature.	Reduce the ambient operating temperature to 40°C or less.
	Servomotor surface dirty	Visually check the surface.	Clean dust and oil from the surface.
	Servomotor overloaded	Check the load status with monitor.	If overloaded, reduce load or replace with larger capacity SERVOPACK and servomotor.
	Polarity detection is not performed correctly.	Check if the value of Un004 (electrical angle 2 from polarity origin) at an arbitrary position is between ±10 degrees.	Correct the settings for the polarity detection related parameter.

---

## Appendix

9.1 List of Parameters .....9-2

9.2 Parameter Recording Table .....9-22



(cont'd)

Parameter No.	Size	Name	Setting Range	Units	Factory Setting	When Enabled	Classification	Reference Section																															
Pn002	2	Application Function Select Switch 2	0000 to 4113	–	0000	After restart	Setup	–																															
	<div style="display: flex; justify-content: space-around; align-items: flex-start;"> <div style="text-align: center;"> <p>4th digit</p> <p>n. <input type="checkbox"/></p> </div> <div style="text-align: center;"> <p>3rd digit</p> <p><input type="checkbox"/></p> </div> <div style="text-align: center;"> <p>2nd digit</p> <p><input type="checkbox"/></p> </div> <div style="text-align: center;"> <p>1st digit</p> <p><input type="checkbox"/></p> </div> </div>		<table border="1" style="width: 100%; border-collapse: collapse;"> <thead> <tr style="background-color: #e0e0e0;"> <th colspan="2">Force Limit Reference Selection for Command Option Module</th> <th>Reference Section</th> </tr> </thead> <tbody> <tr> <td style="text-align: center;">0</td> <td>Disables the force limit reference from the command option module.</td> <td rowspan="4" style="text-align: center; vertical-align: middle;">*1</td> </tr> <tr> <td style="text-align: center;">1</td> <td>Enables the force limit reference from the command option module.</td> </tr> <tr> <td style="text-align: center;">2</td> <td>Reserved (Do not use.)</td> </tr> <tr> <td style="text-align: center;">3</td> <td>Enables the force limit reference from the command option module when external input signals P-CL and N-CL are enabled.</td> </tr> </tbody> </table>						Force Limit Reference Selection for Command Option Module		Reference Section	0	Disables the force limit reference from the command option module.	*1	1	Enables the force limit reference from the command option module.	2	Reserved (Do not use.)	3	Enables the force limit reference from the command option module when external input signals P-CL and N-CL are enabled.																			
	Force Limit Reference Selection for Command Option Module		Reference Section																																				
	0	Disables the force limit reference from the command option module.	*1																																				
	1	Enables the force limit reference from the command option module.																																					
	2	Reserved (Do not use.)																																					
	3	Enables the force limit reference from the command option module when external input signals P-CL and N-CL are enabled.																																					
			<table border="1" style="width: 100%; border-collapse: collapse;"> <thead> <tr style="background-color: #e0e0e0;"> <th colspan="2">Speed Limit Reference Selection for Command Option Module</th> <th>Reference Section</th> </tr> </thead> <tbody> <tr> <td style="text-align: center;">0</td> <td>Disables the speed limit reference when force limit is used from the command option module.</td> <td rowspan="2" style="text-align: center; vertical-align: middle;">*1</td> </tr> <tr> <td style="text-align: center;">1</td> <td>Enables the speed limit reference when force limit is used from the command option module.</td> </tr> </tbody> </table>						Speed Limit Reference Selection for Command Option Module		Reference Section	0	Disables the speed limit reference when force limit is used from the command option module.	*1	1	Enables the speed limit reference when force limit is used from the command option module.																							
	Speed Limit Reference Selection for Command Option Module		Reference Section																																				
	0	Disables the speed limit reference when force limit is used from the command option module.	*1																																				
1	Enables the speed limit reference when force limit is used from the command option module.																																						
		<table border="1" style="width: 100%; border-collapse: collapse;"> <thead> <tr style="background-color: #e0e0e0;"> <th colspan="2">Absolute Linear Scale Usage</th> <th>Reference Section</th> </tr> </thead> <tbody> <tr> <td style="text-align: center;">0</td> <td>Uses absolute linear scale as an absolute linear scale.</td> <td rowspan="2" style="text-align: center; vertical-align: middle;">4.5</td> </tr> <tr> <td style="text-align: center;">1</td> <td>Uses absolute linear scale as an incremental linear scale.</td> </tr> </tbody> </table>						Absolute Linear Scale Usage		Reference Section	0	Uses absolute linear scale as an absolute linear scale.	4.5	1	Uses absolute linear scale as an incremental linear scale.																								
Absolute Linear Scale Usage		Reference Section																																					
0	Uses absolute linear scale as an absolute linear scale.	4.5																																					
1	Uses absolute linear scale as an incremental linear scale.																																						
		Reserved (Do not change.)																																					
Pn006	2	Application Function Select Switch 6	0000 to 005F	–	0002	Immediately	Setup	5.1.3																															
	<div style="display: flex; justify-content: space-around; align-items: flex-start;"> <div style="text-align: center;"> <p>4th digit</p> <p>n. <input type="checkbox"/></p> </div> <div style="text-align: center;"> <p>3rd digit</p> <p><input type="checkbox"/></p> </div> <div style="text-align: center;"> <p>2nd digit</p> <p><input type="checkbox"/></p> </div> <div style="text-align: center;"> <p>1st digit</p> <p><input type="checkbox"/></p> </div> </div>		<table border="1" style="width: 100%; border-collapse: collapse;"> <thead> <tr style="background-color: #e0e0e0;"> <th colspan="2">Analog Monitor 1 Signal Selection</th> </tr> </thead> <tbody> <tr><td style="text-align: center;">00</td><td>Motor moving speed (1 V / 1000 mm/s)</td></tr> <tr><td style="text-align: center;">01</td><td>Speed reference (1 V / 1000 mm/s)</td></tr> <tr><td style="text-align: center;">02</td><td>Force reference (1 V/100% rated force)</td></tr> <tr><td style="text-align: center;">03</td><td>Position error (0.05 V/1 reference unit)</td></tr> <tr><td style="text-align: center;">04</td><td>Position amplifier error (after electronic gears) (0.05 V/ 1 linear scale pulse unit)</td></tr> <tr><td style="text-align: center;">05</td><td>Position reference speed (1 V / 1000 mm/s)</td></tr> <tr><td style="text-align: center;">06</td><td>Reserved (Do not use.)</td></tr> <tr><td style="text-align: center;">07</td><td>Reserved (Do not use.)</td></tr> <tr><td style="text-align: center;">08</td><td>Positioning completion (positioning completed: 5 V, positioning not completed: 0 V)</td></tr> <tr><td style="text-align: center;">09</td><td>Speed feedforward (1 V / 1000 mm/s)</td></tr> <tr><td style="text-align: center;">0A</td><td>Force feedforward (1 V/100% rated force)</td></tr> <tr><td style="text-align: center;">0B</td><td>Active gain (1st gain: 1 V, 2nd gain: 2 V)</td></tr> <tr><td style="text-align: center;">0C</td><td>Completion of position reference (completed: 5 V, not completed: 0 V)</td></tr> <tr><td style="text-align: center;">0D</td><td>Reserved (Do not use.)</td></tr> </tbody> </table>						Analog Monitor 1 Signal Selection		00	Motor moving speed (1 V / 1000 mm/s)	01	Speed reference (1 V / 1000 mm/s)	02	Force reference (1 V/100% rated force)	03	Position error (0.05 V/1 reference unit)	04	Position amplifier error (after electronic gears) (0.05 V/ 1 linear scale pulse unit)	05	Position reference speed (1 V / 1000 mm/s)	06	Reserved (Do not use.)	07	Reserved (Do not use.)	08	Positioning completion (positioning completed: 5 V, positioning not completed: 0 V)	09	Speed feedforward (1 V / 1000 mm/s)	0A	Force feedforward (1 V/100% rated force)	0B	Active gain (1st gain: 1 V, 2nd gain: 2 V)	0C	Completion of position reference (completed: 5 V, not completed: 0 V)	0D	Reserved (Do not use.)	
	Analog Monitor 1 Signal Selection																																						
	00	Motor moving speed (1 V / 1000 mm/s)																																					
	01	Speed reference (1 V / 1000 mm/s)																																					
	02	Force reference (1 V/100% rated force)																																					
	03	Position error (0.05 V/1 reference unit)																																					
	04	Position amplifier error (after electronic gears) (0.05 V/ 1 linear scale pulse unit)																																					
	05	Position reference speed (1 V / 1000 mm/s)																																					
	06	Reserved (Do not use.)																																					
07	Reserved (Do not use.)																																						
08	Positioning completion (positioning completed: 5 V, positioning not completed: 0 V)																																						
09	Speed feedforward (1 V / 1000 mm/s)																																						
0A	Force feedforward (1 V/100% rated force)																																						
0B	Active gain (1st gain: 1 V, 2nd gain: 2 V)																																						
0C	Completion of position reference (completed: 5 V, not completed: 0 V)																																						
0D	Reserved (Do not use.)																																						
		Reserved (Do not change.)																																					
		Reserved (Do not change.)																																					

\*1. For details on this function, refer to the manual of the connected command option module.

(cont'd)

Parameter No.	Size	Name	Setting Range	Units	Factory Setting	When Enabled	Classification	Reference Section																															
<b>Pn007</b>	2	Application Function Select Switch 7	0000 to 005F	–	0000	Immediately	Setup	5.1.3																															
	<p>4th digit 3rd digit 2nd digit 1st digit n. <input type="checkbox"/> <input type="checkbox"/> <input type="checkbox"/> <input type="checkbox"/></p> <table border="1"> <thead> <tr> <th colspan="2">Analog Monitor 2 Signal Selection</th> </tr> </thead> <tbody> <tr><td>00</td><td>Motor moving speed (1 V / 1000 mm/s)</td></tr> <tr><td>01</td><td>Speed reference (1 V / 1000 mm/s)</td></tr> <tr><td>02</td><td>Force reference (1 V/100% rated force)</td></tr> <tr><td>03</td><td>Position error (0.05 V/1 reference unit)</td></tr> <tr><td>04</td><td>Position amplifier error (after electronic gears) (0.05 V/ 1 linear scale pulse unit)</td></tr> <tr><td>05</td><td>Position reference speed (1 V / 1000 mm/s)</td></tr> <tr><td>06</td><td>Reserved (Do not use.)</td></tr> <tr><td>07</td><td>Reserved (Do not use.)</td></tr> <tr><td>08</td><td>Positioning completion (positioning completed: 5 V, positioning not completed: 0 V)</td></tr> <tr><td>09</td><td>Speed feedforward (1 V / 1000 mm/s)</td></tr> <tr><td>0A</td><td>Force feedforward (1 V/100% rated force)</td></tr> <tr><td>0B</td><td>Active gain (1st gain: 1 V, 2nd gain: 2 V)</td></tr> <tr><td>0C</td><td>Completion of position reference (completed: 5 V not completed: 0 V)</td></tr> <tr><td>0D</td><td>Reserved (Do not use.)</td></tr> </tbody> </table> <p>Reserved (Do not change.)</p> <p>Reserved (Do not change.)</p>									Analog Monitor 2 Signal Selection		00	Motor moving speed (1 V / 1000 mm/s)	01	Speed reference (1 V / 1000 mm/s)	02	Force reference (1 V/100% rated force)	03	Position error (0.05 V/1 reference unit)	04	Position amplifier error (after electronic gears) (0.05 V/ 1 linear scale pulse unit)	05	Position reference speed (1 V / 1000 mm/s)	06	Reserved (Do not use.)	07	Reserved (Do not use.)	08	Positioning completion (positioning completed: 5 V, positioning not completed: 0 V)	09	Speed feedforward (1 V / 1000 mm/s)	0A	Force feedforward (1 V/100% rated force)	0B	Active gain (1st gain: 1 V, 2nd gain: 2 V)	0C	Completion of position reference (completed: 5 V not completed: 0 V)	0D	Reserved (Do not use.)
	Analog Monitor 2 Signal Selection																																						
	00	Motor moving speed (1 V / 1000 mm/s)																																					
	01	Speed reference (1 V / 1000 mm/s)																																					
	02	Force reference (1 V/100% rated force)																																					
	03	Position error (0.05 V/1 reference unit)																																					
	04	Position amplifier error (after electronic gears) (0.05 V/ 1 linear scale pulse unit)																																					
	05	Position reference speed (1 V / 1000 mm/s)																																					
	06	Reserved (Do not use.)																																					
	07	Reserved (Do not use.)																																					
	08	Positioning completion (positioning completed: 5 V, positioning not completed: 0 V)																																					
	09	Speed feedforward (1 V / 1000 mm/s)																																					
	0A	Force feedforward (1 V/100% rated force)																																					
	0B	Active gain (1st gain: 1 V, 2nd gain: 2 V)																																					
	0C	Completion of position reference (completed: 5 V not completed: 0 V)																																					
	0D	Reserved (Do not use.)																																					
	<b>Pn008</b>	2	Application Function Select Switch 8	0000 to 7121	–	4000	After restart	Setup	–																														
		<p>4th digit 3rd digit 2nd digit 1st digit n. <input type="checkbox"/> <input type="checkbox"/> <input type="checkbox"/> <input type="checkbox"/></p> <table border="1"> <thead> <tr> <th colspan="2">Reserved (Do not change.)</th> <th>Reference Section</th> </tr> </thead> <tbody> <tr> <td>0</td> <td>Does not detect undervoltage.</td> <td rowspan="3">4.2.11</td> </tr> <tr> <td>1</td> <td>Detects warning and limits force by host controller.</td> </tr> <tr> <td>2</td> <td>Detects warning and limits force by Pn424 and Pn425. (Only in the SERVOPACK)</td> </tr> </tbody> </table> <table border="1"> <thead> <tr> <th colspan="2">Warning Detection Selection</th> <th>Reference Section</th> </tr> </thead> <tbody> <tr> <td>0</td> <td>Detects warning.</td> <td rowspan="2">8.2.1</td> </tr> <tr> <td>1</td> <td>Does not detect warning (except for A.971).</td> </tr> </tbody> </table> <p>Reserved (Do not change.)</p>									Reserved (Do not change.)		Reference Section	0	Does not detect undervoltage.	4.2.11	1	Detects warning and limits force by host controller.	2	Detects warning and limits force by Pn424 and Pn425. (Only in the SERVOPACK)	Warning Detection Selection		Reference Section	0	Detects warning.	8.2.1	1	Does not detect warning (except for A.971).											
		Reserved (Do not change.)		Reference Section																																			
0		Does not detect undervoltage.	4.2.11																																				
1		Detects warning and limits force by host controller.																																					
2		Detects warning and limits force by Pn424 and Pn425. (Only in the SERVOPACK)																																					
Warning Detection Selection		Reference Section																																					
0		Detects warning.	8.2.1																																				
1		Does not detect warning (except for A.971).																																					

(cont'd)

Parameter No.	Size	Name	Setting Range	Units	Factory Setting	When Enabled	Classification	Reference Section	
Pn009	2	Application Function Select Switch 9	0000 to 0111	–	0010	After restart	Tuning	–	
	<div style="display: flex; justify-content: space-around;"> <span>4th digit</span> <span>3rd digit</span> <span>2nd digit</span> <span>1st digit</span> </div> <div style="display: flex; justify-content: space-around;"> <input type="checkbox"/> <input type="checkbox"/> <input type="checkbox"/> <input type="checkbox"/> </div>								
			Reserved (Do not change.)						
			Current Control Method Selection						Reference Section
			0	Current control method 1					5.8.3
			1	Current control method 2					
			Speed Detection Method Selection						Reference Section
			0	Speed detection 1					5.8.5
			1	Speed detection 2					
			Reserved (Do not change.)						
Pn00B	2	Application Function Select Switch B	0000 to 1111	–	0000	After restart	Setup	–	
	<div style="display: flex; justify-content: space-around;"> <span>4th digit</span> <span>3rd digit</span> <span>2nd digit</span> <span>1st digit</span> </div> <div style="display: flex; justify-content: space-around;"> <input type="checkbox"/> <input type="checkbox"/> <input type="checkbox"/> <input type="checkbox"/> </div>								
			Parameter Display Selection						Reference Section
			0	Setup parameters					2.4.1
			1	All parameters					
			Alarm Gr.2 Stop Method Selection						Reference Section
			0	Stops the motor by setting the speed reference to "0".					4.2.8
			1	Same setting as Pn001.0 (Stops the motor by applying DB or by coasting).					
			Power Supply Method for Three-phase SERVOPACK						Reference Section
			0	Three-phase power supply					3.1.3
		1	Single-phase power supply						
		Reserved (Do not change.)							
Pn00C	2	Application Function Select Switch C	0000 to 0111	–	0000	After restart	Setup	4.3, 4.3.1	
	<div style="display: flex; justify-content: space-around;"> <span>4th digit</span> <span>3rd digit</span> <span>2nd digit</span> <span>1st digit</span> </div> <div style="display: flex; justify-content: space-around;"> <input type="checkbox"/> <input type="checkbox"/> <input type="checkbox"/> <input type="checkbox"/> </div>								
			Selection of Test without a Motor						
			0	Disables test without a motor.					
			1	Enables test without a motor.					
			Reserved (Do not change.)						
			Encoder Type for Test without a Motor						
			0	Incremental linear scale					
			1	Absolute linear scale					
			Reserved (Do not change.)						

(cont'd)

Parameter No.	Size	Name	Setting Range	Units	Factory Setting	When Enabled	Classification	Reference Section	
Pn00D	2	Application Function Select Switch D	0000 to 1001	–	0000	Immediately	Setup	–	
	<div style="display: flex; justify-content: space-around;"> <span>4th digit</span><span>3rd digit</span><span>2nd digit</span><span>1st digit</span> </div> <div style="display: flex; justify-content: space-around;"> <input type="checkbox"/> <input type="checkbox"/> <input type="checkbox"/> <input type="checkbox"/> </div>								
			<b>Stand-alone Mode (Test Operation) Selection</b>						
			0	Enables connection with the command option module.					
			1	Disables connection with the command option module.					
			Reserved (Do not change.)						
			Reserved (Do not change.)						
			<b>Overtravel Warning Detection Selection</b>						
			0	Does not detect overtravel warning.					Reference Section 4.2.3
			1	Detects overtravel warning.					
Pn010	2	Axis Address Selection	0000 to 007F	–	0001	After restart	Setup	–	
Pn080	2	Application Function Select Switch 80	0000 to 1111	–	0000	After restart	Setup	–	
	<div style="display: flex; justify-content: space-around;"> <span>4th digit</span><span>3rd digit</span><span>2nd digit</span><span>1st digit</span> </div> <div style="display: flex; justify-content: space-around;"> <input type="checkbox"/> <input type="checkbox"/> <input type="checkbox"/> <input type="checkbox"/> </div>								
			<b>Hall Sensor Selection</b>						
			0	Enables selection.					
			1	Disables selection.					
			<b>Motor Phase Selection</b>						
			0	Sets phase A lead as phase sequence of U,V,W.					
			1	Sets phase B lead as phase sequence of U,V,W.					
			Reserved (Do not change.)						
			<b>Calculation Method for Maximum Speed or Divided Output Pulses</b>						
		0	Determines divided output pulses with fixed maximum speed.						
		1	Determines maximum speed with fixed divided output pulses.						
Pn081	2	Application Function Select Switch 81	0000 to 1111	–	0000	After restart	Setup	4.2.5	
	<div style="display: flex; justify-content: space-around;"> <span>4th digit</span><span>3rd digit</span><span>2nd digit</span><span>1st digit</span> </div> <div style="display: flex; justify-content: space-around;"> <input type="checkbox"/> <input type="checkbox"/> <input type="checkbox"/> <input type="checkbox"/> </div>								
			<b>Phase-C Pulse Output Selection</b>						
			0	Outputs phase-C pulse only in forward direction.					
			1	Outputs phase-C pulse in forward and reverse direction.					
			Reserved (Do not change.)						
			Reserved (Do not change.)						
			Reserved (Do not change.)						

(cont'd)

Parameter No.	Size	Name	Setting Range	Units	Factory Setting	When Enabled	Classification	Reference Section																		
<b>Pn100</b>	2	Speed Loop Gain	10 to 20000	0.1 Hz	400	Immediately	Tuning	5.8.1																		
<b>Pn101</b>	2	Speed Loop Integral Time Constant	15 to 51200	0.01 ms	2000	Immediately	Tuning																			
<b>Pn102</b>	2	Position Loop Gain	10 to 20000	0.1/s	400	Immediately	Tuning																			
<b>Pn103</b>	2	Mass Ratio	0 to 20000	1%	100	Immediately	Tuning																			
<b>Pn104</b>	2	2nd Speed Loop Gain	10 to 20000	0.1 Hz	400	Immediately	Tuning																			
<b>Pn105</b>	2	2nd Speed Loop Integral Time Constant	15 to 51200	0.01 ms	2000	Immediately	Tuning																			
<b>Pn106</b>	2	2nd Position Loop Gain	10 to 20000	0.1/s	400	Immediately	Tuning	5.9.1																		
<b>Pn109</b>	2	Feedforward Gain	0 to 100	1%	0	Immediately	Tuning																			
<b>Pn10A</b>	2	Feedforward Filter Time Constant	0 to 6400	0.01 ms	0	Immediately	Tuning																			
<b>Pn10B</b>	2	Application Function for Gain Select Switch	0000 to 5334	–	0000	–	–	–																		
	<div style="display: flex; justify-content: space-around; align-items: center;"> <div style="text-align: center;">             4th digit n. <input type="checkbox"/> </div> <div style="text-align: center;">             3rd digit <input type="checkbox"/> </div> <div style="text-align: center;">             2nd digit <input type="checkbox"/> </div> <div style="text-align: center;">             1st digit <input type="checkbox"/> </div> </div>		<table border="1" style="width: 100%; border-collapse: collapse;"> <thead> <tr> <th colspan="2">Mode Switch Selection</th> <th>When Enabled</th> <th>Classification</th> <th>Reference Section</th> </tr> </thead> <tbody> <tr> <td style="text-align: center;">0</td> <td>Uses internal force reference as the condition (Level setting: Pn10C).</td> <td rowspan="5" style="text-align: center; vertical-align: middle;">Immediately</td> <td rowspan="5" style="text-align: center; vertical-align: middle;">Setup</td> <td rowspan="5" style="text-align: center; vertical-align: middle;">5.9.2</td> </tr> <tr> <td style="text-align: center;">1</td> <td>Uses speed reference as the condition (Level setting: Pn181).</td> </tr> <tr> <td style="text-align: center;">2</td> <td>Uses acceleration as the condition (Level setting: Pn182).</td> </tr> <tr> <td style="text-align: center;">3</td> <td>Uses position error as the condition (Level setting: Pn10F).</td> </tr> <tr> <td style="text-align: center;">4</td> <td>No mode switch function available.</td> </tr> </tbody> </table>						Mode Switch Selection		When Enabled	Classification	Reference Section	0	Uses internal force reference as the condition (Level setting: Pn10C).	Immediately	Setup	5.9.2	1	Uses speed reference as the condition (Level setting: Pn181).	2	Uses acceleration as the condition (Level setting: Pn182).	3	Uses position error as the condition (Level setting: Pn10F).	4	No mode switch function available.
	Mode Switch Selection		When Enabled	Classification	Reference Section																					
	0	Uses internal force reference as the condition (Level setting: Pn10C).	Immediately	Setup	5.9.2																					
	1	Uses speed reference as the condition (Level setting: Pn181).																								
	2	Uses acceleration as the condition (Level setting: Pn182).																								
3	Uses position error as the condition (Level setting: Pn10F).																									
4	No mode switch function available.																									
		<table border="1" style="width: 100%; border-collapse: collapse;"> <thead> <tr> <th colspan="2">Speed Loop Control Method</th> <th>When Enabled</th> <th>Classification</th> <th>Reference Section</th> </tr> </thead> <tbody> <tr> <td style="text-align: center;">0</td> <td>PI control</td> <td rowspan="3" style="text-align: center; vertical-align: middle;">After restart</td> <td rowspan="3" style="text-align: center; vertical-align: middle;">Setup</td> <td rowspan="3" style="text-align: center; vertical-align: middle;">–</td> </tr> <tr> <td style="text-align: center;">1</td> <td>I-P control</td> </tr> <tr> <td style="text-align: center;">2 and 3</td> <td>Reserved (Do not use.)</td> </tr> </tbody> </table>				Speed Loop Control Method		When Enabled	Classification	Reference Section	0	PI control	After restart	Setup	–	1	I-P control	2 and 3	Reserved (Do not use.)							
Speed Loop Control Method		When Enabled	Classification	Reference Section																						
0	PI control	After restart	Setup	–																						
1	I-P control																									
2 and 3	Reserved (Do not use.)																									
		Reserved (Do not change.)																								
		Reserved (Do not change.)																								
<b>Pn10C</b>	2	Mode Switch (force reference)	0 to 800	1%	200	Immediately	Tuning	5.9.2																		
<b>Pn10F</b>	2	Mode Switch (position error)	0 to 10000	1 reference unit	0	Immediately	Tuning																			
<b>Pn11F</b>	2	Position Integral Time Constant	0 to 50000	0.1 ms	0	Immediately	Tuning	5.9.4																		
<b>Pn121</b>	2	Friction Compensation Gain	10 to 1000	1%	100	Immediately	Tuning	5.8.2																		
<b>Pn122</b>	2	2nd Gain for Friction Compensation	10 to 1000	1%	100	Immediately	Tuning																			
<b>Pn123</b>	2	Friction Compensation Coefficient	0 to 100	1%	0	Immediately	Tuning																			
<b>Pn124</b>	2	Friction Compensation Frequency Correction	-10000 to 10000	0.1 Hz	0	Immediately	Tuning																			
<b>Pn125</b>	2	Friction Compensation Gain Correction	1 to 1000	1%	100	Immediately	Tuning																			

(cont'd)

Parameter No.	Size	Name	Setting Range	Units	Factory Setting	When Enabled	Classification	Reference Section																		
<b>Pn131</b>	2	Gain Switching Time 1	0 to 65535	1 ms	0	Immediately	Tuning	5.8.1																		
<b>Pn132</b>	2	Gain Switching Time 2	0 to 65535	1 ms	0	Immediately	Tuning																			
<b>Pn135</b>	2	Gain Switching Waiting Time 1	0 to 65535	1 ms	0	Immediately	Tuning																			
<b>Pn136</b>	2	Gain Switching Waiting Time 2	0 to 65535	1 ms	0	Immediately	Tuning																			
<b>Pn139</b>	2	Automatic Gain Changeover Related Switch 1	0000 to 0052	–	0000	Immediately	Tuning																			
	<div style="display: flex; align-items: flex-start;"> <div style="margin-right: 20px;"> <p>4th digit</p> <p>3rd digit</p> <p>2nd digit</p> <p>1st digit</p> <p>n. <input type="checkbox"/> <input type="checkbox"/> <input type="checkbox"/> <input type="checkbox"/></p> </div> <div> <p><b>Gain Switching Selection Switch*1</b></p> <table border="1" style="width: 100%;"> <tr> <td style="width: 50px;">0</td> <td>Manual gain switching Switches between 1st gain and 2nd gain using the gain switching reference from the command option module.</td> </tr> <tr> <td>1</td> <td>Reserved (Do not use.)</td> </tr> <tr> <td>2</td> <td>Automatic gain switching pattern 1 Changes automatically 1st gain to 2nd gain when the switching condition A is satisfied. Changes automatically 2nd gain to 1st gain when the switching condition A is not satisfied.</td> </tr> </table> <p><b>Gain Switching Condition A</b></p> <table border="1" style="width: 100%;"> <tr> <td style="width: 50px;">0</td> <td>Positioning completion signal (/COIN) ON</td> </tr> <tr> <td>1</td> <td>Positioning completion signal (/COIN) OFF</td> </tr> <tr> <td>2</td> <td>Positioning near signal (/NEAR) ON</td> </tr> <tr> <td>3</td> <td>Positioning near signal (/NEAR) OFF</td> </tr> <tr> <td>4</td> <td>Position reference filter output = 0 and position reference input OFF</td> </tr> <tr> <td>5</td> <td>Position reference input ON</td> </tr> </table> <p>Reserved (Do not change.)</p> <p>Reserved (Do not change.)</p> </div> </div>								0	Manual gain switching Switches between 1st gain and 2nd gain using the gain switching reference from the command option module.	1	Reserved (Do not use.)	2	Automatic gain switching pattern 1 Changes automatically 1st gain to 2nd gain when the switching condition A is satisfied. Changes automatically 2nd gain to 1st gain when the switching condition A is not satisfied.	0	Positioning completion signal (/COIN) ON	1	Positioning completion signal (/COIN) OFF	2	Positioning near signal (/NEAR) ON	3	Positioning near signal (/NEAR) OFF	4	Position reference filter output = 0 and position reference input OFF	5	Position reference input ON
	0	Manual gain switching Switches between 1st gain and 2nd gain using the gain switching reference from the command option module.																								
	1	Reserved (Do not use.)																								
2	Automatic gain switching pattern 1 Changes automatically 1st gain to 2nd gain when the switching condition A is satisfied. Changes automatically 2nd gain to 1st gain when the switching condition A is not satisfied.																									
0	Positioning completion signal (/COIN) ON																									
1	Positioning completion signal (/COIN) OFF																									
2	Positioning near signal (/NEAR) ON																									
3	Positioning near signal (/NEAR) OFF																									
4	Position reference filter output = 0 and position reference input OFF																									
5	Position reference input ON																									
<b>Pn13D</b>	2	Current Gain Level	100 to 2000	1%	2000	Immediately	Tuning	5.8.4																		

\*1. For details on this function, refer to the manual of the connected command option module.

(cont'd)

Parameter No.	Size	Name	Setting Range	Units	Factory Setting	When Enabled	Classification	Reference Section							
<b>Pn140</b>	2	Model Following Control Related Switch	0000 to 1121	–	0100	Immediately	Tuning	–							
	<div style="display: flex; justify-content: space-around; align-items: flex-start;"> <div style="text-align: center;"> <p>4th digit</p> <p>3rd digit</p> <p>2nd digit</p> <p>1st digit</p> <p>n. <input type="checkbox"/> <input type="checkbox"/> <input type="checkbox"/> <input type="checkbox"/></p> </div> <div style="border: 1px solid black; padding: 5px; margin-top: 10px;"> <p><b>Model Following Control Selection</b></p> <table border="1" style="width: 100%; border-collapse: collapse;"> <tr> <td style="width: 20px; text-align: center;">0</td> <td>Does not use model following control.</td> </tr> <tr> <td style="text-align: center;">1</td> <td>Uses model following control.</td> </tr> </table> </div> </div>		0	Does not use model following control.	1	Uses model following control.									
	0	Does not use model following control.													
	1	Uses model following control.													
			<p><b>Vibration Suppression Selection</b></p> <table border="1" style="width: 100%; border-collapse: collapse;"> <tr> <td style="width: 20px; text-align: center;">0</td> <td>Does not perform vibration suppression.</td> </tr> <tr> <td style="text-align: center;">1</td> <td>Performs vibration suppression over the specified frequency.</td> </tr> <tr> <td style="text-align: center;">2</td> <td>Performs vibration suppression over two different kinds of frequencies.</td> </tr> </table>	0	Does not perform vibration suppression.	1	Performs vibration suppression over the specified frequency.	2	Performs vibration suppression over two different kinds of frequencies.						
	0	Does not perform vibration suppression.													
	1	Performs vibration suppression over the specified frequency.													
	2	Performs vibration suppression over two different kinds of frequencies.													
			<p><b>Vibration Suppression Adjustment Selection</b></p> <table border="1" style="width: 100%; border-collapse: collapse;"> <tr> <td style="width: 20px; text-align: center;">0</td> <td>Does not adjust vibration suppression automatically using utility function.</td> <td style="text-align: right;">Reference Section</td> </tr> <tr> <td style="text-align: center;">1</td> <td>Adjusts vibration suppression automatically using utility function.</td> <td style="text-align: right;">5.3.1, 5.4.1, 5.5.1, 5.7.1</td> </tr> </table>	0	Does not adjust vibration suppression automatically using utility function.	Reference Section	1	Adjusts vibration suppression automatically using utility function.	5.3.1, 5.4.1, 5.5.1, 5.7.1						
	0	Does not adjust vibration suppression automatically using utility function.	Reference Section												
1	Adjusts vibration suppression automatically using utility function.	5.3.1, 5.4.1, 5.5.1, 5.7.1													
		<p><b>Selection of Speed Feedforward/Force Feedforward</b></p> <table border="1" style="width: 100%; border-collapse: collapse;"> <tr> <td style="width: 20px; text-align: center;">0</td> <td>Does not use model following control and speed/force feedforward together.</td> <td style="text-align: right;">Reference Section</td> </tr> <tr> <td style="text-align: center;">1</td> <td>Uses model following control and speed/force feedforward together.</td> <td style="text-align: right;">5.3.1, 5.4.1</td> </tr> </table>	0	Does not use model following control and speed/force feedforward together.	Reference Section	1	Uses model following control and speed/force feedforward together.	5.3.1, 5.4.1							
0	Does not use model following control and speed/force feedforward together.	Reference Section													
1	Uses model following control and speed/force feedforward together.	5.3.1, 5.4.1													
<b>Pn141</b>	2	Model Following Control Gain	10 to 20000	0.1/s	500	Immediately	Tuning	–							
<b>Pn142</b>	2	Model Following Control Gain Compensation	500 to 2000	0.1%	1000	Immediately	Tuning	–							
<b>Pn143</b>	2	Model Following Control Bias (Forward Direction)	0 to 10000	0.1%	1000	Immediately	Tuning	–							
<b>Pn144</b>	2	Model Following Control Bias (Reverse Direction)	0 to 10000	0.1%	1000	Immediately	Tuning	–							
<b>Pn145</b>	2	Vibration Suppression 1 Frequency A	10 to 2500	0.1 Hz	500	Immediately	Tuning	–							
<b>Pn146</b>	2	Vibration Suppression 1 Frequency B	10 to 2500	0.1 Hz	700	Immediately	Tuning	–							
<b>Pn147</b>	2	Model Following Control Speed Feedforward Compensation	0 to 10000	0.1%	1000	Immediately	Tuning	–							
<b>Pn148</b>	2	2nd Model Following Control Gain	10 to 20000	0.1/s	500	Immediately	Tuning	–							
<b>Pn149</b>	2	2nd Model Following Control Gain Compensation	500 to 2000	0.1%	1000	Immediately	Tuning	–							
<b>Pn14A</b>	2	Vibration Suppression 2 Frequency	10 to 2000	0.1 Hz	800	Immediately	Tuning	–							
<b>Pn14B</b>	2	Vibration Suppression 2 Compensation	10 to 1000	1%	100	Immediately	Tuning	–							
<b>Pn14F</b>	2	Reserved (Do not change.)	–	–	0011	–	–	–							

(cont'd)

Parameter No.	Size	Name	Setting Range	Units	Factory Setting	When Enabled	Classification	Reference Section		
Pn160	2	Anti-Resonance Control Related Switch	0000 to 0011	–	0010	Immediately	Tuning	5.3.1, 5.4.1, 5.5.1, 5.7.1		
		4th digit 3rd digit 2nd digit 1st digit n. <input type="checkbox"/> <input type="checkbox"/> <input type="checkbox"/> <input type="checkbox"/>								
		Anti-Resonance Control Selection								
		0	Does not use anti-resonance control.							
		1	Uses anti-resonance control.							
		Anti-Resonance Control Adjustment Selection								
		0	Does not adjust anti-resonance control automatically using utility function.							
		1	Adjusts anti-resonance control automatically using utility function.							
		Reserved (Do not change.)								
		Reserved (Do not change.)								
Pn161	2	Anti-Resonance Frequency	10 to 20000	0.1 Hz	1000	Immediately	Tuning	–		
Pn162	2	Anti-Resonance Gain Compensation	1 to 1000	1%	100	Immediately	Tuning	–		
Pn163	2	Anti-Resonance Damping Gain	0 to 300	1%	0	Immediately	Tuning	–		
Pn164	2	Anti-Resonance Filter Time Constant 1 Compensation	-1000 to 1000	0.01 ms	0	Immediately	Tuning	–		
Pn165	2	Anti-Resonance Filter Time Constant 2 Compensation	-1000 to 1000	0.01 ms	0	Immediately	Tuning	–		
Pn170	2	Tuning-less Function Related Switch	0000 to 2411	–	1401	–	–	–		
		4th digit 3rd digit 2nd digit 1st digit n. <input type="checkbox"/> <input type="checkbox"/> <input type="checkbox"/> <input type="checkbox"/>								
		Tuning-less Function Selection					When Enabled	Classification	Reference Section	
		0	Disables tuning-less function.					After restart	Setup	5.2
		1	Enables tuning-less function.							
		Control Method during Speed Control					When Enabled	Classification	Reference Section	
		0	Uses as speed control.					After restart	Setup	5.2
		1	Uses as speed control and uses the host controller for position control.							
		Rigidity Level					When Enabled	Classification	Reference Section	
		0 to 4	Sets the rigidity level.					Immediately	Setup	5.2
	Load Level					When Enabled	Classification	Reference Section		
	0 to 2	Sets the load level.					Immediately	Setup	5.2	
Pn181	2	Mode Switch (Speed Reference)	0 to 10000	1 mm/s	0	Immediately	Tuning	5.9.2		
Pn182	2	Mode Switch (Acceleration)	0 to 30000	1 mm/s <sup>2</sup>	0	Immediately	Tuning			
Pn190	2	Reserved (Do not change.)	–	–	0010	–	–	–		
Pn200	2	Reserved (Do not change.)	–	–	0100	–	–	–		

(cont'd)

Parameter No.	Size	Name	Setting Range	Units	Factory Setting	When Enabled	Classification	Reference Section		
Pn207	2	Position Control Function Switch	0000 to 2210	–	0010	After restart	Setup	–		
	Reserved (Do not change.)									
	Reserved (Do not change.)									
	Reserved (Do not change.)									
		/COIN Output Timing						Reference Section		
		0	Outputs when the position error absolute value is the same or less than the positioning completed width (Pn522).						4.6.6	
		1	Outputs when the position error absolute value is the same or less than the positioning completed width (Pn522), and the reference after position reference filtering is 0.							
		2	Outputs when the position error absolute value is the same or less than the positioning completed width (Pn522), and the position reference input is 0.							
Pn20E	4	Electronic Gear Ratio (Numerator)	1 to 1073741824	1	4	After restart	Setup	4.2.4		
Pn210	4	Electronic Gear Ratio (Denominator)	1 to 1073741824	1	1	After restart	Setup			
Pn281	2	Encoder Output Resolution	1 to 4096	1 edge/pitch	20	After restart	Setup	4.2.6		
Pn282	4	Linear Scale Pitch	0 to 6553600	0.01 μm	0	After restart	Setup	–		
Pn300	2	Reserved (Do not change.)	–	–	600	–	–	–		
Pn305	2	Soft Start Acceleration Time	0 to 10000	1 ms	0	Immediately	Setup	–		
Pn306	2	Soft Start Deceleration Time	0 to 10000	1 ms	0	Immediately	Setup			
Pn307	2	Reserved (Do not change.)	–	–	40	–	–	–		
Pn310	2	Vibration Detection Switch	0000 to 0002	–	0000	Immediately	Setup	–		
			Vibration Detection Selection						Reference Section	
			0	Does not detect vibration.						6.16
			1	Outputs warning (A.911) when vibration is detected.						
		2	Outputs alarm (A.520) when vibration is detected.							
		Reserved (Do not change.)								
		Reserved (Do not change.)								
		Reserved (Do not change.)								
Pn311	2	Vibration Detection Sensibility	50 to 500	1%	100	Immediately	Tuning	6.16		
Pn324	2	Mass Calculating Start Level	0 to 20000	1%	300	Immediately	Setup	5.3.2		
Pn380	2	Reserved (Do not change.)	–	–	10	–	–	–		
Pn381	2	Reserved (Do not change.)	–	–	20	–	–	–		
Pn382	2	Reserved (Do not change.)	–	–	30	–	–	–		
Pn383	2	JOG Speed	0 to 10000	1 mm/s	50	Immediately	Setup	6.3		

(cont'd)

Parameter No.	Size	Name	Setting Range	Units	Factory Setting	When Enabled	Classification	Reference Section	
<b>Pn384</b>	2	Vibration Detection Level	0 to 5000	1 mm/s	10	Immediately	Tuning	6.16	
<b>Pn385</b>	2	Motor Max. Speed	1 to 100	100 mm/s	50	After restart	Setup	4.2.10	
<b>Pn400</b>	2	Reserved (Do not change.)	–	–	30	–	–	–	
<b>Pn401</b>	2	Force Reference Filter Time Constant	0 to 65535	0.01 ms	100	Immediately	Tuning	5.9.3	
<b>Pn404</b>	2	Forward External Force Limit	0 to 800	1%*2	100	Immediately	Setup	4.4.2	
<b>Pn405</b>	2	Reverse External Force Limit	0 to 800	1%*2	100	Immediately	Setup		
<b>Pn406</b>	2	Emergency Stop Force	0 to 800	1%*2	800	Immediately	Setup		
<b>Pn408</b>	2	Force Related Function Switch	0000 to 1111	–	0000	–	–	–	
	4th digit   3rd digit   2nd digit   1st digit n. <input type="checkbox"/> <input type="checkbox"/> <input type="checkbox"/> <input type="checkbox"/>								
			1st Step Notch Filter Selection			When Enabled	Classification	Reference Section	
			0	N/A		Immediately	Setup	5.9.3	
			1	Uses 1st step notch filter for force reference.					
			Speed Limit Selection			When Enabled	Classification	Reference Section	
			0	Uses the smaller of the maximum motor speed and the value of Pn480 as the speed limit value.		After restart	Setup	4.6.8	
			1	Uses the smaller of the overspeed detection speed and the value of Pn480 as the speed limit value.					
			2nd Step Notch Filter Selection			When Enabled	Classification	Reference Section	
			0	N/A		Immediately	Setup	5.9.3	
		1	Uses 2nd step notch filter for force reference.						
		Friction Compensation Function Selection			When Enabled	Classification	Reference Section		
		0	Disables friction compensation function.		Immediately	Setup	5.8.2		
		1	Enables friction compensation function.						
<b>Pn409</b>	2	1st Notch Filter Frequency	50 to 5000	1 Hz	5000	Immediately	Tuning	5.9.3	
<b>Pn40A</b>	2	1st Notch Filter Q Value	50 to 1000	0.01	70	Immediately	Tuning		
<b>Pn40B</b>	2	1st Notch Filter Depth	0 to 1000	0.001	0	Immediately	Tuning		
<b>Pn40C</b>	2	2nd Notch Filter Frequency	50 to 5000	1 Hz	5000	Immediately	Tuning		
<b>Pn40D</b>	2	2nd Notch Filter Q Value	50 to 1000	0.01	70	Immediately	Tuning		
<b>Pn40E</b>	2	2nd Notch Filter Depth	0 to 1000	0.001	0	Immediately	Tuning		
<b>Pn40F</b>	2	2nd Step 2nd Force Reference Filter Frequency	100 to 5000	1 Hz	5000	Immediately	Tuning		
<b>Pn410</b>	2	2nd Step 2nd Force Reference Filter Q Value	50 to 100	0.01	50	Immediately	Tuning		
<b>Pn412</b>	2	1st Step 2nd Force Reference Filter Time Constant	0 to 65535	0.01 ms	100	Immediately	Tuning	5.8.1	
<b>Pn415</b>	2	Reserved (Do not change.)	–	–	0	–	–	–	
<b>Pn423</b>	2	Reserved (Do not change.)	–	–	0000	–	–	–	

\*2. Percentage (%) of rated motor force.

(cont'd)

Parameter No.	Size	Name	Setting Range	Units	Factory Setting	When Enabled	Classification	Reference Section							
<b>Pn424</b>	2	Force Limit at Main Circuit Voltage Drop	0 to 100	1%*2	50	Immediately	Setup	4.2.11							
<b>Pn425</b>	2	Release Time for Force Limit at Main Circuit Voltage Drop	0 to 1000	1 ms	100	Immediately	Setup								
<b>Pn456</b>	2	Sweep Force Reference Amplitude	1 to 800	1%	15	Immediately	Tuning	6.21							
<b>Pn460</b>	2	Notch Filter Adjustment Switch	0000 to 0101	–	0101	Immediately	Tuning	5.2.1 5.3.1 5.5.1							
	<p><b>Notch Filter Adjustment Selection 1</b></p> <table border="1"> <tr> <td>0</td> <td>Does not adjust 1st step notch filter automatically using utility function.</td> </tr> <tr> <td>1</td> <td>Adjust 1st step notch filter automatically using utility function.</td> </tr> </table> <p><b>Reserved (Do not change.)</b></p> <p><b>Notch Filter Adjustment Selection 2</b></p> <table border="1"> <tr> <td>0</td> <td>Does not adjust 2nd step notch filter automatically using utility function.</td> </tr> <tr> <td>1</td> <td>Adjust 2nd step notch filter automatically using utility function.</td> </tr> </table> <p><b>Reserved (Do not change.)</b></p>								0	Does not adjust 1st step notch filter automatically using utility function.	1	Adjust 1st step notch filter automatically using utility function.	0	Does not adjust 2nd step notch filter automatically using utility function.	1
0	Does not adjust 1st step notch filter automatically using utility function.														
1	Adjust 1st step notch filter automatically using utility function.														
0	Does not adjust 2nd step notch filter automatically using utility function.														
1	Adjust 2nd step notch filter automatically using utility function.														
<b>Pn480</b>	2	Speed Limit during Force Control	0 to 10000	1 mm/s	10000	Immediately	Setup	4.6.8							
<b>Pn481</b>	2	Polarity Detection Speed Loop Gain	1 to 20000	0.1 Hz	400	Immediately	Tuning	–							
<b>Pn482</b>	2	Polarity Detection Speed Loop Integral Time Constant	15 to 51200	0.01 ms	3000	Immediately	Tuning	–							
<b>Pn483</b>	2	Forward Force Limit	0 to 800	1%*2	30	Immediately	Setup	4.4.1							
<b>Pn484</b>	2	Reverse Force Limit	0 to 800	1%*2	30	Immediately	Setup								
<b>Pn485</b>	2	Polarity Detection Reference Speed	0 to 100	1 mm/s	20	Immediately	Tuning	–							
<b>Pn486</b>	2	Polarity Detection Reference Accel/Decel Time	0 to 100	1 ms	25	Immediately	Tuning	–							
<b>Pn487</b>	2	Polarity Detection Constant Speed Time	0 to 300	1 ms	0	Immediately	Tuning	–							
<b>Pn488</b>	2	Polarity Detection Reference Waiting Time	50 to 500	1 ms	100	Immediately	Tuning	–							
<b>Pn48E</b>	2	Polarity Detection Range	1 to 65535	1 mm	10	Immediately	Tuning	–							
<b>Pn490</b>	2	Polarity Detection Load Level	0 to 20000	1%	100	Immediately	Tuning	–							
<b>Pn495</b>	2	Polarity Detection Confirmation Force Reference	0 to 200	1%	100	Immediately	Tuning	–							
<b>Pn498</b>	2	Polarity Detection Allowable Error Range	0 to 30	1 deg	10	Immediately	Tuning	–							
<b>Pn506</b>	2	Brake Reference - Servo OFF Delay Time	0 to 50	10 ms	0	Immediately	Setup	4.2.7							
<b>Pn508</b>	2	Waiting Time for Brake Signal When Motor Running	10 to 100	10 ms	50	Immediately	Setup								
<b>Pn509</b>	2	Instantaneous Power Cut Hold time	20 to 1000	1 ms	20	Immediately	Setup	4.2.9							

\*2. Percentage (%) of rated motor force.

(cont'd)

Parameter No.	Size	Name	Setting Range	Units	Factory Setting	When Enabled	Classification	Reference Section	
<b>Pn50A</b>	2	Input Signal Selection 1	0000 to FFF1	–	1881	After restart	Setup	–	
	<div style="display: flex; justify-content: space-around; align-items: flex-start;"> <div style="text-align: center;"> <p>4th digit</p> <input type="checkbox"/> </div> <div style="text-align: center;"> <p>3rd digit</p> <input type="checkbox"/> </div> <div style="text-align: center;"> <p>2nd digit</p> <input type="checkbox"/> </div> <div style="text-align: center;"> <p>1st digit</p> <input type="checkbox"/> </div> </div> <p>n.</p>		Reserved (Do not change.)						4.2.3
	Reserved (Do not change.)								
	Reserved (Do not change.)								
	P-OT Signal Mapping							Reference Section	
	0		Forward run allowed when CN1-13 input signal is ON (closed).						
	1		Forward run allowed when CN1-7 input signal is ON (closed).						
	2		Forward run allowed when CN1-8 input signal is ON (closed).						
	3		Forward run allowed when CN1-9 input signal is ON (closed).						
	4		Forward run allowed when CN1-10 input signal is ON (closed).						
	5		Forward run allowed when CN1-11 input signal is ON (closed).						
	6		Forward run allowed when CN1-12 input signal is ON (closed).						
	7		Forward run prohibited.						
	8		Forward run allowed.						
	9		Forward run allowed when CN1-13 input signal is OFF (open).						
	A		Forward run allowed when CN1-7 input signal is OFF (open).						
	B		Forward run allowed when CN1-8 input signal is OFF (open).						
C		Forward run allowed when CN1-9 input signal is OFF (open).							
D		Forward run allowed when CN1-10 input signal is OFF (open).							
E		Forward run allowed when CN1-11 input signal is OFF (open).							
F		Forward run allowed when CN1-12 input signal is OFF (open).							

(cont'd)

Parameter No.	Size	Name	Setting Range	Units	Factory Setting	When Enabled	Classification	Reference Section		
Pn50B	2	Input Signal Selection 2	0000 to FFFF	–	8882	After restart	Setup	–		
	<div style="display: flex; justify-content: space-around; align-items: flex-start;"> <div style="text-align: center;"> <p>4th digit</p> <input type="checkbox"/> </div> <div style="text-align: center;"> <p>3rd digit</p> <input type="checkbox"/> </div> <div style="text-align: center;"> <p>2nd digit</p> <input type="checkbox"/> </div> <div style="text-align: center;"> <p>1st digit</p> <input type="checkbox"/> </div> </div> <p>n.</p>									
			<b>N-OT Signal Mapping</b>						Reference Section	
			0	Reverse run allowed when CN1-13 input signal is ON (closed).						4.2.3
			1	Reverse run allowed when CN1-7 input signal is ON (closed).						
			2	Reverse run allowed when CN1-8 input signal is ON (closed).						
			3	Reverse run allowed when CN1-9 input signal is ON (closed).						
			4	Reverse run allowed when CN1-10 input signal is ON (closed).						
			5	Reverse run allowed when CN1-11 input signal is ON (closed).						
			6	Reverse run allowed when CN1-12 input signal is ON (closed).						
		7	Reverse run prohibited.							
		8	Reverse run allowed.							
		9	Reverse run allowed when CN1-13 input signal is OFF (open).							
		A	Reverse run allowed when CN1-7 input signal is OFF (open).							
		B	Reverse run allowed when CN1-8 input signal is OFF (open).							
		C	Reverse run allowed when CN1-9 input signal is OFF (open).							
		D	Reverse run allowed when CN1-10 input signal is OFF (open).							
		E	Reverse run allowed when CN1-11 input signal is OFF (open).							
		F	Reverse run allowed when CN1-12 input signal is OFF (open).							
		<b>Reserved (Do not change.)</b>								
		<b>/P-CL Signal Mapping</b>						Reference Section		
		0	Active when CN1-13 input signal is ON (closed).						4.4.2	
		1	Active when CN1-7 input signal is ON (closed).							
		2	Active when CN1-8 input signal is ON (closed).							
		3	Active when CN1-9 input signal is ON (closed).							
		4	Active when CN1-10 input signal is ON (closed).							
		5	Active when CN1-11 input signal is ON (closed).							
		6	Active when CN1-12 input signal is ON (closed).							
		7	Always active (fixed).							
		8	Not active (fixed).							
		9	Active when CN1-13 input signal is OFF (open).							
		A	Active when CN1-7 input signal is OFF (open).							
		B	Active when CN1-8 input signal is OFF (open).							
		C	Active when CN1-9 input signal is OFF (open).							
		D	Active when CN1-10 input signal is OFF (open).							
		E	Active when CN1-11 input signal is OFF (open).							
		F	Active when CN1-12 input signal is OFF (open).							
		<b>/N-CL Signal Mapping</b>						Reference Section		
		0 to F	Same as /P-CL signal mapping						4.4.2	

(cont'd)

Parameter No.	Size	Name	Setting Range	Units	Factory Setting	When Enabled	Classification	Reference Section		
Pn50E	2	Output Signal Selection 1	0000 to 3333	–	0000	After restart	Setup	–		
		4th digit <input type="checkbox"/> 3rd digit <input type="checkbox"/> 2nd digit <input type="checkbox"/> 1st digit <input type="checkbox"/> n. <input type="checkbox"/>							Reference Section	
			Positioning Completion Signal Mapping (/COIN)						4.6.6	
			0	Disabled (the above signal is not used.)						
			1	Outputs the signal from CN1-1, 2 output terminal.						
			2	Outputs the signal from CN1-23, 24 output terminal.						
				Speed Coincidence Detection Signal Mapping (/V-CMP)						Reference Section
			0 to 3	Same as /COIN Signal Mapping.					4.6.5	
				Servomotor Movement Detection Signal Mapping (/TGON)						Reference Section
			0 to 3	Same as /COIN Signal Mapping.					4.6.3	
				Servo Ready Signal Mapping (/S-RDY)						Reference Section
			0 to 3	Same as /COIN Signal Mapping.					4.6.4	
	Pn50F	2	Output Signal Selection 2	0000 to 3333	–	0100	After restart	Setup	–	
		4th digit <input type="checkbox"/> 3rd digit <input type="checkbox"/> 2nd digit <input type="checkbox"/> 1st digit <input type="checkbox"/> n. <input type="checkbox"/>							Reference Section	
			Force Limit Detection Signal Mapping (/CLT)						4.4.3	
			0	Disabled (the above signal is not used.)						
			1	Outputs the signal from CN1-1, 2 output terminal.						
			2	Outputs the signal from CN1-23, 24 output terminal.						
				Speed Limit Detection Signal Mapping (/VLT)						Reference Section
			0 to 3	Same as /CLT Signal Mapping.					4.6.8	
				Brake Signal Mapping (/BK)						Reference Section
			0 to 3	Same as /CLT Signal Mapping.					4.2.7	
				Warning Signal Mapping (/WARN)						Reference Section
			0 to 3	Same as /CLT Signal Mapping.					4.6.2	

(cont'd)

Parameter No.	Size	Name	Setting Range	Units	Factory Setting	When Enabled	Classification	Reference Section	
<b>Pn510</b>	2	Output Signal Selection 3	0000 to 0333	–	0000	After restart	Setup	–	
	<div style="display: flex; justify-content: space-around; align-items: flex-start;"> <div style="text-align: center;"> <p>4th digit</p> <p>n. <input type="checkbox"/></p> </div> <div style="text-align: center;"> <p>3rd digit</p> <p><input type="checkbox"/></p> </div> <div style="text-align: center;"> <p>2nd digit</p> <p><input type="checkbox"/></p> </div> <div style="text-align: center;"> <p>1st digit</p> <p><input type="checkbox"/></p> </div> </div>								Reference Section
	Near Signal Mapping (/NEAR)								4.6.7
	0		Disabled (the above signal is not used.)						
	1		Outputs the signal from CN1-1, 2 terminal.						
	2		Outputs the signal from CN1-23, 24 terminal.						
	3		Outputs the signal from CN1-25, 26 terminal.						
	Reserved (Do not change.)								
	Reserved (Do not change.)								
	Reserved (Do not change.)								

(cont'd)

Parameter No.	Size	Name	Setting Range	Units	Factory Setting	When Enabled	Classification	Reference Section																																			
Pn511	2	Input Signal Selection 5	0000 to FFFF	–	6543	After restart	Setup	3.3.1																																			
		<div style="display: flex; justify-content: space-around; align-items: flex-start;"> <div style="text-align: center;"> <p>4th digit</p> <p>n. <input type="checkbox"/></p> </div> <div style="text-align: center;"> <p>3rd digit</p> <p><input type="checkbox"/></p> </div> <div style="text-align: center;"> <p>2nd digit</p> <p><input type="checkbox"/></p> </div> <div style="text-align: center;"> <p>1st digit</p> <p><input type="checkbox"/></p> </div> </div>																																									
				<table border="1" style="width: 100%; border-collapse: collapse;"> <thead> <tr> <th colspan="2" style="background-color: #cccccc;">Input Signal 3 Mapping for Command Option Module (/SI3)</th> </tr> </thead> <tbody> <tr><td>0</td><td>Active when CN1-13 input signal is ON (closed).</td></tr> <tr><td>1</td><td>Active when CN1-7 input signal is ON (closed).</td></tr> <tr><td>2</td><td>Active when CN1-8 input signal is ON (closed).</td></tr> <tr><td>3</td><td>Active when CN1-9 input signal is ON (closed).</td></tr> <tr><td>4</td><td>Active when CN1-10 input signal is ON (closed).</td></tr> <tr><td>5</td><td>Active when CN1-11 input signal is ON (closed).</td></tr> <tr><td>6</td><td>Active when CN1-12 input signal is ON (closed).</td></tr> <tr><td>7</td><td>Always active.</td></tr> <tr><td>8</td><td>Always not active.</td></tr> <tr><td>9</td><td>Active when CN1-13 input signal is OFF (open).</td></tr> <tr><td>A</td><td>Active when CN1-7 input signal is OFF (open).</td></tr> <tr><td>B</td><td>Active when CN1-8 input signal is OFF (open).</td></tr> <tr><td>C</td><td>Active when CN1-9 input signal is OFF (open).</td></tr> <tr><td>D</td><td>Active when CN1-10 input signal is OFF (open).</td></tr> <tr><td>E</td><td>Active when CN1-11 input signal is OFF (open).</td></tr> <tr><td>F</td><td>Active when CN1-12 input signal is OFF (open).</td></tr> </tbody> </table>						Input Signal 3 Mapping for Command Option Module (/SI3)		0	Active when CN1-13 input signal is ON (closed).	1	Active when CN1-7 input signal is ON (closed).	2	Active when CN1-8 input signal is ON (closed).	3	Active when CN1-9 input signal is ON (closed).	4	Active when CN1-10 input signal is ON (closed).	5	Active when CN1-11 input signal is ON (closed).	6	Active when CN1-12 input signal is ON (closed).	7	Always active.	8	Always not active.	9	Active when CN1-13 input signal is OFF (open).	A	Active when CN1-7 input signal is OFF (open).	B	Active when CN1-8 input signal is OFF (open).	C	Active when CN1-9 input signal is OFF (open).	D	Active when CN1-10 input signal is OFF (open).	E	Active when CN1-11 input signal is OFF (open).	F	Active when CN1-12 input signal is OFF (open).
	Input Signal 3 Mapping for Command Option Module (/SI3)																																										
	0	Active when CN1-13 input signal is ON (closed).																																									
	1	Active when CN1-7 input signal is ON (closed).																																									
	2	Active when CN1-8 input signal is ON (closed).																																									
	3	Active when CN1-9 input signal is ON (closed).																																									
	4	Active when CN1-10 input signal is ON (closed).																																									
	5	Active when CN1-11 input signal is ON (closed).																																									
6	Active when CN1-12 input signal is ON (closed).																																										
7	Always active.																																										
8	Always not active.																																										
9	Active when CN1-13 input signal is OFF (open).																																										
A	Active when CN1-7 input signal is OFF (open).																																										
B	Active when CN1-8 input signal is OFF (open).																																										
C	Active when CN1-9 input signal is OFF (open).																																										
D	Active when CN1-10 input signal is OFF (open).																																										
E	Active when CN1-11 input signal is OFF (open).																																										
F	Active when CN1-12 input signal is OFF (open).																																										
			<table border="1" style="width: 100%; border-collapse: collapse;"> <thead> <tr> <th colspan="2" style="background-color: #cccccc;">Input Signal 4 Mapping for Command Option Module (/SI4)</th> </tr> </thead> <tbody> <tr><td>0 to 3</td><td>Always not active.</td></tr> <tr><td>4</td><td>Active when CN1-10 input signal is ON (closed).</td></tr> <tr><td>5</td><td>Active when CN1-11 input signal is ON (closed).</td></tr> <tr><td>6</td><td>Active when CN1-12 input signal is ON (closed).</td></tr> <tr><td>7 to C</td><td>Always not active.</td></tr> <tr><td>D</td><td>Active when CN1-10 input signal is OFF (open).</td></tr> <tr><td>E</td><td>Active when CN1-11 input signal is OFF (open).</td></tr> <tr><td>F</td><td>Active when CN1-12 input signal is OFF (open).</td></tr> </tbody> </table>						Input Signal 4 Mapping for Command Option Module (/SI4)		0 to 3	Always not active.	4	Active when CN1-10 input signal is ON (closed).	5	Active when CN1-11 input signal is ON (closed).	6	Active when CN1-12 input signal is ON (closed).	7 to C	Always not active.	D	Active when CN1-10 input signal is OFF (open).	E	Active when CN1-11 input signal is OFF (open).	F	Active when CN1-12 input signal is OFF (open).																	
Input Signal 4 Mapping for Command Option Module (/SI4)																																											
0 to 3	Always not active.																																										
4	Active when CN1-10 input signal is ON (closed).																																										
5	Active when CN1-11 input signal is ON (closed).																																										
6	Active when CN1-12 input signal is ON (closed).																																										
7 to C	Always not active.																																										
D	Active when CN1-10 input signal is OFF (open).																																										
E	Active when CN1-11 input signal is OFF (open).																																										
F	Active when CN1-12 input signal is OFF (open).																																										
			<table border="1" style="width: 100%; border-collapse: collapse;"> <thead> <tr> <th colspan="2" style="background-color: #cccccc;">Input Signal 5 Mapping for Command Option Module (/SI5)</th> </tr> </thead> <tbody> <tr><td>0 to F</td><td>Same as /SI4 signal mapping.</td></tr> </tbody> </table>						Input Signal 5 Mapping for Command Option Module (/SI5)		0 to F	Same as /SI4 signal mapping.																															
Input Signal 5 Mapping for Command Option Module (/SI5)																																											
0 to F	Same as /SI4 signal mapping.																																										
			<table border="1" style="width: 100%; border-collapse: collapse;"> <thead> <tr> <th colspan="2" style="background-color: #cccccc;">Input Signal 6 Mapping for Command Option Module (/SI6)</th> </tr> </thead> <tbody> <tr><td>0 to F</td><td>Same as /SI4 signal mapping.</td></tr> </tbody> </table>						Input Signal 6 Mapping for Command Option Module (/SI6)		0 to F	Same as /SI4 signal mapping.																															
Input Signal 6 Mapping for Command Option Module (/SI6)																																											
0 to F	Same as /SI4 signal mapping.																																										

(cont'd)

Parameter No.	Size	Name	Setting Range	Units	Factory Setting	When Enabled	Classification	Reference Section							
<b>Pn512</b>	2	Output Signal Inverse Setting	0000 to 0111	–	0000	After restart	Setup	3.3.2							
	<table border="1"> <tr> <th colspan="2">Output Signal Inversion for CN1-1 or -2 Terminal</th> </tr> <tr> <td>0</td> <td>Does not invert outputs.</td> </tr> <tr> <td>1</td> <td>Inverts outputs.</td> </tr> </table>									Output Signal Inversion for CN1-1 or -2 Terminal		0	Does not invert outputs.	1	Inverts outputs.
	Output Signal Inversion for CN1-1 or -2 Terminal														
	0	Does not invert outputs.													
	1	Inverts outputs.													
	<table border="1"> <tr> <th colspan="2">Output Signal Inversion for CN1-23 or -24 Terminal</th> </tr> <tr> <td>0</td> <td>Does not invert outputs.</td> </tr> <tr> <td>1</td> <td>Inverts outputs.</td> </tr> </table>									Output Signal Inversion for CN1-23 or -24 Terminal		0	Does not invert outputs.	1	Inverts outputs.
	Output Signal Inversion for CN1-23 or -24 Terminal														
	0	Does not invert outputs.													
	1	Inverts outputs.													
<table border="1"> <tr> <th colspan="2">Output Signal Inversion for CN1-25 or -26 Terminal</th> </tr> <tr> <td>0</td> <td>Does not invert outputs.</td> </tr> <tr> <td>1</td> <td>Inverts outputs.</td> </tr> </table>									Output Signal Inversion for CN1-25 or -26 Terminal		0	Does not invert outputs.	1	Inverts outputs.	
Output Signal Inversion for CN1-25 or -26 Terminal															
0	Does not invert outputs.														
1	Inverts outputs.														
<table border="1"> <tr> <th colspan="2">Reserved (Do not change.)</th> </tr> </table>									Reserved (Do not change.)						
Reserved (Do not change.)															
<b>Pn513</b>	2	Reserved (Do not change.)	–	–	0000	–	–	–							
<b>Pn517</b>	2	Reserved (Do not change.)	–	–	0000	–	–	–							
<b>Pn51E</b>	2	Excessive Position Error Warning Level	10 to 100	1%	100	Immediately	Setup	8.2.1							
<b>Pn520</b>	4	Excessive Position Error Alarm Level	1 to 1073741823	1 reference unit	5242880	Immediately	Setup	5.1.4 8.1.1							
<b>Pn522</b>	4	Positioning Completed Width	0 to 1073741824	1 reference unit	7	Immediately	Setup	4.6.6							
<b>Pn524</b>	4	NEAR Signal Width	1 to 1073741824	1 reference unit	1073741824	Immediately	Setup	4.6.7							
<b>Pn526</b>	4	Excessive Position Error Alarm Level at Servo ON	1 to 1073741823	1 reference unit	5242880	Immediately	Setup	5.1.4							
<b>Pn528</b>	2	Excessive Position Error Warning Level at Servo ON	10 to 100	1%	100	Immediately	Setup								
<b>Pn52B</b>	2	Overload Warning Level	1 to 100	1%	20	Immediately	Setup	4.2.12							
<b>Pn52C</b>	2	Derating of Base Current at Detecting Overload of Motor	10 to 100	1%	100	After restart	Setup								
<b>Pn52D</b>	2	Reserved (Do not change.)	–	–	50	–	–	–							
<b>Pn52F</b>	2	Reserved (Do not change.)	–	–	0FFF	–	–	–							

(cont'd)

Parameter No.	Size	Name	Setting Range	Units	Factory Setting	When Enabled	Classification	Reference Section																					
<b>Pn530</b>	2	Program JOG Operation Related Switch	0000 to 0005	–	0000	Immediately	Setup	6.5																					
		4th digit □ 3rd digit □ 2nd digit □ 1st digit □ n. □	<table border="1"> <thead> <tr> <th colspan="2">Program JOG Operation Switch</th> </tr> </thead> <tbody> <tr> <td>0</td> <td>(Waiting time Pn535 → Forward movement Pn531) × Number of movements Pn536</td> </tr> <tr> <td>1</td> <td>(Waiting time Pn535 → Reverse movement Pn531) × Number of movements Pn536</td> </tr> <tr> <td>2</td> <td>(Waiting time Pn535 → Forward movement Pn531) × Number of movements Pn536 (Waiting time Pn535 → Reverse movement Pn531) × Number of movements Pn536</td> </tr> <tr> <td>3</td> <td>(Waiting time Pn535 → Reverse movement Pn531) × Number of movements Pn536 (Waiting time Pn535 → Forward movement Pn531) × Number of movements Pn536</td> </tr> <tr> <td>4</td> <td>(Waiting time Pn535 → Forward movement Pn531 → Waiting time Pn535 → Reverse movement Pn531) × Number of movements Pn536</td> </tr> <tr> <td>5</td> <td>(Waiting time Pn535 → Reverse movement Pn531 → Waiting time Pn535 → Forward movement Pn531) × Number of movements Pn536</td> </tr> <tr> <td colspan="2">Reserved (Do not change.)</td> </tr> <tr> <td colspan="2">Reserved (Do not change.)</td> </tr> <tr> <td colspan="2">Reserved (Do not change.)</td> </tr> </tbody> </table>							Program JOG Operation Switch		0	(Waiting time Pn535 → Forward movement Pn531) × Number of movements Pn536	1	(Waiting time Pn535 → Reverse movement Pn531) × Number of movements Pn536	2	(Waiting time Pn535 → Forward movement Pn531) × Number of movements Pn536 (Waiting time Pn535 → Reverse movement Pn531) × Number of movements Pn536	3	(Waiting time Pn535 → Reverse movement Pn531) × Number of movements Pn536 (Waiting time Pn535 → Forward movement Pn531) × Number of movements Pn536	4	(Waiting time Pn535 → Forward movement Pn531 → Waiting time Pn535 → Reverse movement Pn531) × Number of movements Pn536	5	(Waiting time Pn535 → Reverse movement Pn531 → Waiting time Pn535 → Forward movement Pn531) × Number of movements Pn536	Reserved (Do not change.)		Reserved (Do not change.)		Reserved (Do not change.)	
	Program JOG Operation Switch																												
	0	(Waiting time Pn535 → Forward movement Pn531) × Number of movements Pn536																											
	1	(Waiting time Pn535 → Reverse movement Pn531) × Number of movements Pn536																											
	2	(Waiting time Pn535 → Forward movement Pn531) × Number of movements Pn536 (Waiting time Pn535 → Reverse movement Pn531) × Number of movements Pn536																											
	3	(Waiting time Pn535 → Reverse movement Pn531) × Number of movements Pn536 (Waiting time Pn535 → Forward movement Pn531) × Number of movements Pn536																											
	4	(Waiting time Pn535 → Forward movement Pn531 → Waiting time Pn535 → Reverse movement Pn531) × Number of movements Pn536																											
	5	(Waiting time Pn535 → Reverse movement Pn531 → Waiting time Pn535 → Forward movement Pn531) × Number of movements Pn536																											
	Reserved (Do not change.)																												
Reserved (Do not change.)																													
Reserved (Do not change.)																													
<b>Pn531</b>	4	Program JOG Movement Distance	1 to 1073741824	1 reference unit	32768	Immediately	Setup	6.5																					
<b>Pn534</b>	2	Program JOG Acceleration/Deceleration Time	2 to 10000	1 ms	100	Immediately	Setup																						
<b>Pn535</b>	2	Program JOG Waiting Time	0 to 10000	1 ms	100	Immediately	Setup																						
<b>Pn536</b>	2	Number of Times of Program JOG Movement	0 to 1000	1 time	1	Immediately	Setup																						
<b>Pn550</b>	2	Analog Monitor 1 Offset Voltage	-10000 to 10000	0.1 V	0	Immediately	Setup	5.1.3																					
<b>Pn551</b>	2	Analog Monitor 2 Offset Voltage	-10000 to 10000	0.1 V	0	Immediately	Setup																						
<b>Pn552</b>	2	Analog Monitor Magnification (×1)	-10000 to 10000	×0.01	100	Immediately	Setup																						
<b>Pn553</b>	2	Analog Monitor Magnification (×2)	-10000 to 10000	×0.01	100	Immediately	Setup																						
<b>Pn560</b>	2	Remained Vibration Detection Width	1 to 3000	0.1%	400	Immediately	Setup	5.7.1																					
<b>Pn561</b>	2	Overshoot Detection Level	0 to 100	1%	100	Immediately	Setup	5.3.1 5.4.1																					
<b>Pn580</b>	2	Zero Clamp Level	0 to 10000	1 mm/s	10	Immediately	Setup	–																					
<b>Pn581</b>	2	Zero Speed Level	1 to 10000	1 mm/s	20	Immediately	Setup	4.6.3																					
<b>Pn582</b>	2	Speed Coincidence Signal Output Width	0 to 100	1 mm/s	10	Immediately	Setup	4.6.5																					
<b>Pn583</b>	2	Brake Reference Output Speed Level	0 to 10000	1 mm/s	10	Immediately	Setup	4.2.7																					
<b>Pn584</b>	2	Speed Limit Level at Servo ON	0 to 10000	1 mm/s	10000	Immediately	Setup	5.1.4																					
<b>Pn585</b>	2	Program JOG Movement Speed	1 to 10000	1 mm/s	50	Immediately	Setup	6.5																					
<b>Pn586</b>	2	Motor Running Air-cooling Ratio	0 to 100	1%/maximum speed	0	Immediately	Setup	–																					

(cont'd)

Parameter No.	Size	Name	Setting Range	Units	Factory Setting	When Enabled	Classification	Reference Section
<b>Pn587</b>	2	Polarity Detection for Absolute Scale Selection	0000 to 0001	–	0000	Immediately	Setup	–
		4th digit □   3rd digit □   2nd digit □   1st digit □ n. □ □ □ □						
			Polarity Detection for Absolute Scale Selection					
			0	Does not detect polarity.				
			1	Detects polarity.				
			Reserved (Do not change.)					
			Reserved (Do not change.)					
			Reserved (Do not change.)					
<b>Pn600</b>	2	Regenerative Resistor Capacity *3	Depends on SERVO-PACK Capacity *4	10 W	0	Immediately	Setup	3.7.2
<b>Pn601</b>	2	Reserved (Do not change.)	–	–	0	–	–	–
<b>Pn800 to Pn95F</b> *5	–	Reserved (Do not change.)	–	–	0	–	–	–

\*3. Normally set to 0. If you use an external regenerative resistor, set the capacity (W) of the regenerative resistor.

\*4. The upper limit is the maximum output capacity (W) of the SERVOPACK.

\*5. For details on Pn800 to Pn95F, refer to the manual of the connected command option module.

## 9.2 Parameter Recording Table

Use the following table for recording parameters.

Parameter	Factory Setting						Name	When Enabled
Pn000	0000						Basic Function Select Switch 0	After restart
Pn001	0000						Application Function Select Switch 1	After restart
Pn002	0000						Application Function Select Switch 2	After restart
Pn006	0002						Application Function Select Switch 6	Immediately
Pn007	0000						Application Function Select Switch 7	Immediately
Pn008	4000						Application Function Select Switch 8	After restart
Pn009	0010						Application Function Select Switch 9	After restart
Pn00B	0000						Application Function Select Switch B	After restart
Pn00C	0000						Application Function Select Switch C	After restart
Pn00D	0000						Application Function Select Switch D	Immediately
Pn010	0001						Axis Address Selection (for UART/USB communications)	After restart
Pn080	0000						Application Function Select Switch 80	After restart
Pn081	0000						Application Function Select Switch 81	After restart
Pn100	400						Speed Loop Gain	Immediately
Pn101	2000						Speed Loop Integral Time Constant	Immediately
Pn102	400						Position Loop Gain	Immediately
Pn103	100						Mass Ratio	Immediately
Pn104	400						2nd Speed Loop Gain	Immediately
Pn105	2000						2nd Speed Loop Integral Time Constant	Immediately
Pn106	400						2nd Position Loop Gain	Immediately
Pn109	0						Feedforward Gain	Immediately
Pn10A	0						Feedforward Filter Time Constant	Immediately
Pn10B	0000						Application Function for Gain Select Switch	*
Pn10C	200						Mode Switch (force reference)	Immediately
Pn10F	0						Mode Switch (position error)	Immediately
Pn11F	0						Position Integral Time Constant	Immediately
Pn121	100						Friction Compensation Gain	Immediately
Pn122	100						2nd Gain for Friction Compensation	Immediately
Pn123	0						Friction Compensation Coefficient	Immediately
Pn124	0						Friction Compensation Frequency Correction	Immediately
Pn125	100						Friction Compensation Gain Correction	Immediately
Pn131	0						Gain Switching Time 1	Immediately
Pn132	0						Gain Switching Time 2	Immediately
Pn135	0						Gain Switching Waiting Time 1	Immediately
Pn136	0						Gain Switching Waiting Time 2	Immediately
Pn139	0000						Automatic Gain Changeover Related Switch 1	Immediately

\* Changes are enabled at different times depending on the digit. For details, refer to 9.1 List of Parameters.

(cont'd)

Parameter	Factory Setting					Name	When Enabled
Pn13D	2000					Current Gain Level	Immediately
Pn140	0100					Model Following Control Related Switch	Immediately
Pn141	500					Model Following Control Gain	Immediately
Pn142	1000					Model Following Control Gain Compensation	Immediately
Pn143	1000					Model Following Control Bias (Forward Direction)	Immediately
Pn144	1000					Model Following Control Bias (Reverse Direction)	Immediately
Pn145	500					Vibration Suppression 1 Frequency A	Immediately
Pn146	700					Vibration Suppression 1 Frequency B	Immediately
Pn147	1000					Model Following Control Speed Feedforward Compensation	Immediately
Pn148	500					2nd Model Following Control Gain	Immediately
Pn149	1000					2nd Model Following Control Gain Compensation	Immediately
Pn14A	800					Vibration Suppression 2 Frequency	Immediately
Pn14B	100					Vibration Suppression 2 Compensation	Immediately
Pn14F	0011					Reserved	–
Pn160	0010					Anti-Resonance Control Related Switch	Immediately
Pn161	1000					Anti-Resonance Frequency	Immediately
Pn162	100					Anti-Resonance Gain Compensation	Immediately
Pn163	0					Anti-Resonance Damping Gain	Immediately
Pn164	0					Anti-Resonance Filter Time Constant 1 Compensation	Immediately
Pn165	0					Anti-Resonance Filter Time Constant 2 Compensation	Immediately
Pn170	1401					Tuning-less Function Related Switch	*
Pn181	0					Mode Switch (Speed Reference)	Immediately
Pn182	0					Mode Switch (Acceleration)	Immediately
Pn190	0010					Reserved	–
Pn200	0100					Reserved	–
Pn207	0010					Position Control Function Switch	After restart
Pn20E	4					Electronic Gear Ratio (Numerator)	After restart
Pn210	1					Electronic Gear Ratio (Denominator)	After restart
Pn281	20					Encoder Output Resolution	After restart
Pn282	0					Linear Scale Pitch	After restart
Pn300	600					Reserved	–
Pn305	0					Soft Start Acceleration Time	Immediately
Pn306	0					Soft Start Deceleration Time	Immediately
Pn307	40					Reserved	–
Pn310	0000					Vibration Detection Switch	Immediately
Pn311	100					Vibration Detection Sensibility	Immediately
Pn324	300					Mass Calculating Start Level	Immediately

\* Changes are enabled at different times depending on the digit. For details, refer to 9.1 List of Parameters.

(cont'd)

Parameter	Factory Setting					Name	When Enabled
Pn380	10					Reserved	Immediately
Pn381	20					Reserved	Immediately
Pn382	30					Reserved	Immediately
Pn383	50					JOG Speed	Immediately
Pn384	10					Vibration Detection Level	Immediately
Pn385	50					Motor Max. Speed	After restart
Pn400	30					Reserved	–
Pn401	100					Force Reference Filter Time Constant	Immediately
Pn404	100					Forward External Force Limit	Immediately
Pn405	100					Reverse External Force Limit	Immediately
Pn406	800					Emergency Stop Force	Immediately
Pn408	0000					Force Related Function Switch	*
Pn409	5000					1st Notch Filter Frequency	Immediately
Pn40A	70					1st Notch Filter Q Value	Immediately
Pn40B	0					1st Notch Filter Depth	Immediately
Pn40C	5000					2nd Notch Filter Frequency	Immediately
Pn40D	70					2nd Notch Filter Q Value	Immediately
Pn40E	0					2nd Notch Filter Depth	Immediately
Pn40F	5000					2nd Step 2nd Force Reference Filter Frequency	Immediately
Pn410	50					2nd Step 2nd Force Reference Filter Q Value	Immediately
Pn412	100					1st Step 2nd Force Reference Filter Time Constant	Immediately
Pn415	0					Reserved	–
Pn423	0000					Reserved	–
Pn424	50					Force Limit at Main Circuit Voltage Drop	Immediately
Pn425	100					Release Time for Force Limit at Main Circuit Voltage Drop	Immediately
Pn456	15					Sweep Force Reference Amplitude	Immediately
Pn460	0101					Notch Filter Adjustment Switch	Immediately
Pn480	10000					Speed Limit during Force Control	Immediately
Pn481	400					Polarity Detection Speed Loop Gain	Immediately
Pn482	3000					Polarity Detection Speed Loop Integral Time Constant	Immediately
Pn483	30					Forward Force Limit	Immediately
Pn484	30					Reverse Force Limit	Immediately
Pn485	20					Polarity Detection Reference Speed	Immediately
Pn486	25					Polarity Detection Reference Accel/Decel Time	Immediately
Pn487	0					Polarity Detection Constant Speed Time	Immediately
Pn488	100					Polarity Detection Reference Waiting Time	Immediately
Pn48E	10					Polarity Detection Range	Immediately
Pn490	100					Polarity Detection Load Level	Immediately

\* Changes are enabled at different times depending on the digit. For details, refer to 9.1 List of Parameters.

(cont'd)

Parameter	Factory Setting					Name	When Enabled
Pn495	100					Polarity Detection Confirmation Force Reference	Immediately
Pn498	10					Polarity Detection Allowable Error Range	Immediately
Pn506	0					Brake Reference - Servo OFF Delay Time	Immediately
Pn508	50					Waiting Time for Brake Signal When Motor Running	Immediately
Pn509	20					Instantaneous Power Cut Hold Time	Immediately
Pn50A	1881					Input Signal Selection 1	After restart
Pn50B	8882					Input Signal Selection 2	After restart
Pn50E	0000					Output Signal Selection 1	After restart
Pn50F	0100					Output Signal Selection 2	After restart
Pn510	0000					Output Signal Selection 3	After restart
Pn511	6543					Input Signal Selection 5	After restart
Pn512	0000					Output Signal Inverse Setting	After restart
Pn513	0000					Reserved	–
Pn517	0000					Reserved	–
Pn51E	100					Excessive Position Error Warning Level	Immediately
Pn520	5242880					Excessive Position Error Alarm Level	Immediately
Pn522	7					Positioning Completed Width	Immediately
Pn524	1073741824					NEAR Signal Width	Immediately
Pn526	5242880					Excessive Position Error Alarm Level at Servo ON	Immediately
Pn528	100					Excessive Position Error Warning Level at Servo ON	Immediately
Pn52B	20					Overload Warning Level	Immediately
Pn52C	100					Derating of Base Current at Detecting Overload of Motor	After restart
Pn52D	50					Reserved	–
Pn52F	0FFF					Reserved	–
Pn530	0000					Program JOG Operation Related Switch	Immediately
Pn531	32768					Program JOG Movement Distance	Immediately
Pn534	100					Program JOG Acceleration/Deceleration Time	Immediately
Pn535	100					Program JOG Waiting Time	Immediately
Pn536	1					Number of Times of Program JOG Movement	Immediately
Pn550	0					Analog Monitor 1 Offset Voltage	Immediately
Pn551	0					Analog Monitor 2 Offset Voltage	Immediately
Pn552	100					Analog Monitor Magnification (×1)	Immediately
Pn553	100					Analog Monitor Magnification (×2)	Immediately
Pn560	400					Remained Vibration Detection Width	Immediately
Pn561	100					Overshoot Detection Level	Immediately
Pn580	10					Zero Clamp Level	Immediately
Pn581	20					Zero Speed Level	Immediately

(cont'd)

Parameter	Factory Setting						Name	When Enabled
<b>Pn582</b>	10						Speed Coincidence Signal Output Width	Immediately
<b>Pn583</b>	10						Brake Reference Output Speed Level	Immediately
<b>Pn584</b>	10000						Speed Limit Level at Servo ON	Immediately
<b>Pn585</b>	50						Program JOG Movement Speed	Immediately
<b>Pn586</b>	0						Motor Running Air-cooling Ratio	Immediately
<b>Pn587</b>	0000						Polarity Detection for Absolute Scale Selection	Immediately
<b>Pn600</b>	0						Regenerative Resistor Capacity	Immediately
<b>Pn601</b>	0						Reserved	—

# Index

## Symbols

/BK	4-21
/CLT	4-36
/COIN	4-44
/HWBB1	4-51
/HWBB2	4-51
/N-CL	4-35
/NEAR	4-45
/P-CL	4-35
/S-RDY	4-43
/TGON	4-42
/V-CMP	4-43
/VLT	4-46
/WARN	4-41

## A

absolute data reception sequence	4-38
absolute data request (sensor ON command)	4-37
absolute linear scales	4-37
AC reactor	3-40
additional adjustment function	5-53
advanced autotuning (Fn201)	5-15
anti-resonance control adjustment function	5-22
calculating mass	5-18
feedforward	5-23
friction compensation	5-23
mode selection	5-18
notch filter	5-22
STROKE (travel distance) setting	5-19
type selection	5-18
vibration suppression	5-22
advanced autotuning by reference (Fn202)	5-25
anti-resonance control adjustment function	5-29
feedforward	5-30
friction compensation	5-30
mode selection	5-27
notch filter	5-29
type selection	5-27
vibration suppression	5-29
alarm history display (Fn000)	6-3
alarm reset	8-2
alarm reset method	4-41
ALM	4-41
ambient operating temperature	1-4
ambient/storage humidity	1-4
anti-resonance control adjustment function (Fn204)	5-42
application example of safety functions	4-55
automatic gain switching	5-54
automatic offset-signal adjustment of the motor current detection signal (Fn00E)	6-18
automatically setting the notch filter	5-11

## B

baseblock	2-2
BB	-iii, 4-33
brake operation delay time	4-19
brake signals	4-21

## C

CE	-xv
----	-----

changing detection timing of overload (low load) alarm (A.720)	4-30
changing detection timing of overload warning (A.910)	4-29
checking output force limiting during operation	4-36
clearing alarm history (Fn006)	6-13
CN1	3-17
CN2	3-27
CN3	1-2
CN7	1-2
CN8	3-18
coast to a stop	4-7
compatible adjustment function	5-60
confirming safety functions	4-56
connecting a reactor for harmonic suppression	3-40
connecting regenerative resistors	3-34
connection example of EDM1 output signal	4-54
connection example of HWBB input signals	4-51
connection to host controller (interface)	
sequence input circuit	3-23
sequence output circuit	3-24
connector CN5 for analog monitor	5-5
current control mode selection	5-59
current gain level setting	5-59

## D

DC power supply input	
parameter setting	3-13
wiring example	3-14
DC reactor	3-40
decelerate to stop	4-7
digital operator displays during testing without motor	4-33
DIP switch (SW2)	4-3
display of SERVOPACK and servomotor ID (Fn01E)	6-28
dynamic brake	4-7

## E

EasyFFT (Fn206)	6-33
EDM1	4-53
electronic gear	4-9
electronic gear ratio	4-9
encoder output pulse setting	4-18
encoder output pulses	4-12
encoder output resolution	4-18
error detection in HWBB signal	4-50
european directives	xv
example of I/O signal connections	3-19
external device monitor	4-53
external force limit	4-35
external regenerative resistor	3-34

## F

feedforward	5-60
feedforward compensation	5-60
FG	3-18, 3-19
force control tolerance	1-4
force limit function for low DC power supply voltage for main circuit	4-26
force reference filter	5-63
forward external force limit	4-35
forward force limit	4-35
friction compensation	5-57

## G

gain adjustment of analog monitor output (Fn00D)	6-16
Gr.1 alarm	4-24
Gr.2 alarm	4-24

grounding ----- 3-38

## H

hard wire base block (HWBB) function ----- 4-48  
 hard wire base block (HWBB) state ----- 4-49  
 harmonized standards ----- xv, 1-4  
 holding brakes ----- 4-19

## I

initial incremental pulses ----- 4-39  
 initializing parameter settings (Fn005) ----- 6-12  
 input signal (CN1)  
   allocations ----- 3-20  
   monitoring ----- 7-4  
   names and functions ----- 3-17  
 instantaneous power interruption settings ----- 4-25  
 internal block diagrams ----- 1-7  
 internal force limit ----- 4-34

## J

JOG operation (Fn002) ----- 6-4

## L

limit switches ----- 4-6  
 limiting force ----- 4-34  
 linear scale connection examples ----- 3-30  
   absolute linear scale made by Magnescale Co., Ltd. ----- 3-33  
   absolute linear scale made by Mitutoyo ----- 3-33  
   incremental linear scale made by Heidenhain ----- 3-30  
   incremental linear scale made by Magnescale Co., Ltd. ----- 3-31  
   incremental linear scale made by Renishaw plc ----- 3-30  
 linear scale signal (CN2) names and functions ----- 3-27  
 list of alarms ----- 8-2  
 list of monitor displays ----- 7-2  
 list of parameters ----- 9-2  
 list of warnings ----- 8-25

## M

main circuit  
   names and functions of terminals ----- 3-2  
   wires ----- 3-3, 3-10  
   wiring examples ----- 3-5  
 manual gain switching ----- 5-54  
 manual offset-signal adjustment of the motor current detection  
 signal (Fn00F) ----- 6-19  
 monitor displays (Un□□□) ----- 2-7  
 monitor factor ----- 5-6  
 monitoring safety input signals ----- 7-7  
 movement detection output signal ----- 4-42

## N

noise filter ----- 3-38  
 N-OT ----- 3-17, 4-6  
 notch filter ----- 5-65

## O

offset adjustment of analog monitor output (Fn00C) ----- 6-14  
 oil seal replacement ----- 1-20  
 one-parameter tuning (Fn203) ----- 5-32  
   anti-resonance control adjustment function ----- 5-37  
   feedforward ----- 5-38  
   friction compensation ----- 5-38  
   notch filter ----- 5-37  
   tuning mode ----- 5-33, 5-35  
   type selection ----- 5-33, 5-35  
 one-parameter tuning example ----- 5-39

online vibration monitor (Fn207) ----- 6-36  
 origin search (Fn003) ----- 6-6  
 origin setting (Fn020) ----- 6-30  
 output phase form ----- 4-12  
 output signal (CN1)  
   allocations ----- 3-22  
   monitoring ----- 7-6  
   names and functions ----- 3-18  
 overtravel (OT) ----- 4-6  
 overtravel warning function ----- 4-8

## P

PAO ----- 4-12, 4-38  
 parameter  
   classification ----- 2-4  
   how to make numeric settings using parameters ----- 2-5  
   how to select functions using parameters ----- 2-6  
   parameters for numeric settings ----- iv, 2-4  
   parameters for selecting functions ----- iv, 2-4  
   tuning parameters ----- 2-4  
 parameter recording table ----- 9-22  
 PBO ----- 4-12, 4-38  
 PCO ----- 4-12, 4-38  
 polarity detection (Fn080) ----- 6-32  
 position integral ----- 5-65  
 positioning completed signal ----- 4-44  
 positioning near signal ----- 4-45  
 P-OT ----- 3-17, 4-6  
 precautions for safety functions ----- 4-58  
 precautions for wiring ----- 3-16  
 precautions on connecting noise filter ----- 3-39  
 program JOG operation (Fn004) ----- 6-8  
 protection class/pollution degree ----- 1-4

## R

reference unit ----- 4-9  
 resetting configuration errors in option modules (Fn014) ----- 6-25  
 resetting the HWBB state ----- 4-50  
 reverse external force limit ----- 4-35  
 risk assessment ----- 4-49  
 rotary switch (SW1) ----- 4-3  
 RUN ----- 4-33

## S

safety function ----- 4-48  
 safety function signal (CN8) names and functions ----- 3-18  
 safety performance ----- xvi  
 safety precautions on adjustment of servo gains ----- 5-8  
 safety standards ----- xv  
 SEMI F47 function ----- 4-26  
 serial converter unit ----- 3-27  
   model designations ----- 3-28  
   specifications ----- 3-27  
 serial data ----- 4-39, 4-40  
 servo alarm output signal ----- 4-41  
 servo gains ----- 5-3  
 servo ready output signal ----- 4-42  
 servomotor inspection ----- 1-20  
 servomotor model display (Fn011) ----- 6-23  
 servomotor movement direction ----- 4-4

<b>SERVOPACK</b>	
basic specifications	1-4
example of servo system configuration (SGDV-□□□AE5A)	1-15
example of servo system configuration (SGDV-□□□DE5A)	1-17
example of servo system configuration (SGDV-□□□FE5A)	1-14
inspection and maintenance	1-19
model designation	1-18
part names	1-2
precautions when using more than one SERVOPACK	3-15
ratings	1-3
status display	2-2
setting motor overload detection level	4-29
setting regenerative resistor capacity	3-36
/SI0	3-17
/SI3	3-17
/SI4	3-17
/SI5	3-17
/SI6	3-17
single-phase, 200 V power supply input	
main circuit wire for SERVOPACKs	3-10
molded-case circuit breaker	3-12
parameter setting	3-10
power supply capacities and power losses	3-11
wire types	3-3
wiring example	3-11
software reset (Fn030)	6-31
software version display (Fn012)	6-24
specifications of EDM1 output signal	4-54
specifications of HWBB signals	4-51
speed coincidence signal	4-43
speed control range	1-4
speed detection method selection	5-59
speed limit in force control	4-46
speed regulation	1-4
standard power supply input	
main circuit wires for SERVOPACKs	3-3
molded-case circuit breaker	3-9
power supply capacities and power losses	3-8
wire types	3-3
wiring examples	3-5
stopping method for servomotor after servo OFF command is received	4-23
stopping method for servomotor when an alarm occurs	4-24, 8-2
storage temperature	1-4
switching condition A	5-54
switching gain settings	5-53

## T

test without motor function	4-31
time stamps	6-3
troubleshooting	
alarms	8-7
warnings	8-26
troubleshooting malfunction based on operation and conditions of the servomotor	8-30
tuning parameters	2-4
tuning-less function	5-10
tuning-less level settings (Fn200)	5-11

## U

UL	xv
using the mode switch (P/PI switching)	5-61
utility functions (Fn□□□)	2-3

## V

vibration detection level initialization (Fn01B)	6-26
vibration suppression function (Fn205)	5-48
vibration/shock resistance	1-4

## W

warning output signal	4-41
wire types	3-3
wiring for noise control	3-37
write prohibited setting (Fn010)	6-21

## Z

zero clamp mode	4-7
zero-speed stopping	iii

## Revision History

The revision dates and numbers of the revised manuals are given on the bottom of the back cover.

MANUAL NO. SIEP S800000 66A <0>-1  
 Published in Japan November 2010

WEB revision number  
 Revision number  
 Date of publication

Date of Publication	Rev. No.	WEB Rev. No.	Section	Revised Content			
September 2016	<5>	0	Front cover	Revision: Format			
			All chapters	Completely revised			
			Back cover	Revision: Address and format			
September 2014	<4>	0	3.6.2 (3)	Revision: Description of analog signal input timing			
July 2014	<3>	0	3.6.3 (2), 4.2.4 (1)	Addition: Absolute linear scale by Heidenhain (models: LIC4100-series models)			
			4.7.5	Addition: Information on types of safety function's jumper connectors			
			8.1.1, 8.1.2	Addition: A.861 and A.F50			
August 2013	<2>	0	Preface, 1.4.2	Revision: Description of Applicable Standards EN55011/A2 changed to EN55011			
			Back cover	Revision: Address			
November 2011	<1>	0	Front cover	Revision: Description of technical terms, Manuals related to the $\Sigma$ -V series, Safety precautions			
			1.2	Addition: SERVOPACKs			
			1.4.1, 1.7	Deletion: SGD V single-phase 200-V ratings			
			Chapter 3, 4	Slightly revised			
			5.1.4 (3), 5.1.4 (5), 6.5 (2), 9.1.2	Revision: Description of related parameters			
			9.1, 9.3	Addition: Pn081			
November 2010	<0>	1	Front cover	Revision: Format			
			3.4.1 (2), 3.4.2 (3), 4.7.1, 4.7.1 (5), 4.7.2 (1), 4.7.3 (1)	Revision: Connection example			
			3.6.2 (4), 4.2.4 (1), 4.5.1, Index	Revision: Company name Sony Manufacturing Systems → Magnescale Co., Ltd.			
			4.2.6, 9.1.2	Revision: Setting units of Pn281			
			5.3.1(1), 5.4.1(1)	Revision: Description of things to do before advanced autotuning and advanced autotuning by reference			
			5.8.1 (4), (5)	Revision: Applicable control method			
			5.8.4	Revision: Description of current gain level setting			
			8.1.2	Revision: Note of A.042			
			9.1.2	Revision: Description of the second digit (Speed Limit Selection) of Pn408			
			9.1.2, 9.3	Addition: Pn517 (Reserved Parameter)			
			Back cover	Revision: Address, format Addition: Original instructions			
			November 2009	-	0	-	First edition

# AC Servo Drives

# $\Sigma$ -V Series

# USER'S MANUAL

# Design and Maintenance

## Linear Motor

## Command Option Attachable Type

---

#### **IRUMA BUSINESS CENTER (SOLUTION CENTER)**

480, Kamifujisawa, Iruma, Saitama, 358-8555, Japan  
Phone 81-4-2962-5151 Fax 81-4-2962-6138  
<http://www.yaskawa.co.jp>

#### **YASKAWA AMERICA, INC.**

2121, Norman Drive South, Waukegan, IL 60085, U.S.A.  
Phone 1-800-YASKAWA (927-5292) or 1-847-887-7000 Fax 1-847-887-7310  
<http://www.yaskawa.com>

#### **YASKAWA ELÉTRICO DO BRASIL LTDA.**

777, Avenida Piraporinha, Diadema, São Paulo, 09950-000, Brasil  
Phone 55-11-3585-1100 Fax 55-11-3585-1187  
<http://www.yaskawa.com.br>

#### **YASKAWA EUROPE GmbH**

185, Hauptstraße, Eschborn, 65760, Germany  
Phone 49-6196-569-300 Fax 49-6196-569-398  
<http://www.yaskawa.eu.com>

#### **YASKAWA ELECTRIC KOREA CORPORATION**

9F, Kyobo Securities Bldg. 26-4, Yeouido-dong, Yeongdeungpo-gu, Seoul, 150-737, Korea  
Phone 82-2-784-7844 Fax 82-2-784-8495  
<http://www.yaskawa.co.kr>

#### **YASKAWA ELECTRIC (SINGAPORE) PTE. LTD.**

151, Lorong Chuan, #04-02A, New Tech Park, 556741, Singapore  
Phone 65-6282-3003 Fax 65-6289-3003  
<http://www.yaskawa.com.sg>

#### **YASKAWA ELECTRIC (THAILAND) CO., LTD.**

59, 1st-5th Floor, Flourish Building, Soi Ratchadapisek 18, Ratchadapisek Road, Huaykwang, Bangkok, 10310, Thailand  
Phone 66-2-017-0099 Fax 66-2-017-0799  
<http://www.yaskawa.co.th>

#### **YASKAWA ELECTRIC (CHINA) CO., LTD.**

22F, One Corporate Avenue, No.222, Hubin Road, Shanghai, 200021, China  
Phone 86-21-5385-2200 Fax 86-21-5385-3299  
<http://www.yaskawa.com.cn>

#### **YASKAWA ELECTRIC (CHINA) CO., LTD. BEIJING OFFICE**

Room 1011, Tower W3 Oriental Plaza, No.1, East Chang An Ave.,  
Dong Cheng District, Beijing, 100738, China  
Phone 86-10-8518-4086 Fax 86-10-8518-4082

#### **YASKAWA ELECTRIC TAIWAN CORPORATION**

9F, 16, Nanking E. Rd., Sec. 3, Taipei, 104, Taiwan  
Phone 886-2-2502-5003 Fax 886-2-2505-1280

---

# YASKAWA

**YASKAWA ELECTRIC CORPORATION**

In the event that the end user of this product is to be the military and said product is to be employed in any weapons systems or the manufacture thereof, the export will fall under the relevant regulations as stipulated in the Foreign Exchange and Foreign Trade Regulations. Therefore, be sure to follow all procedures and submit all relevant documentation according to any and all rules, regulations and laws that may apply. Specifications are subject to change without notice for ongoing product modifications and improvements.

© 2009-2016 YASKAWA ELECTRIC CORPORATION

MANUAL NO. SIEP S800000 66F <5>-0

Published in Japan September 2016  
15-8-11

Original instructions